

DCP551 Mark II DIGITRONIK Digital Control Programmer User's Manual



Thank you for purchasing the DCP551 Mark II DIGITRONIK Digital Control Programmer.

This manual contains information for ensuring correct use of the DCP551. It also provides necessary information for installation, maintenance, and troubleshooting.

This manual should be read by those who design and maintain devices that use the DCP551. Be sure to keep this manual nearby for handy reference.

Yamatake Corporation

RESTRICTIONS ON USE

This product has been designed, developed and manufactured for general-purpose application in machinery and equipment.

Accordingly, when used in applications outlined below, special care should be taken to implement a fail-safe and/or redundant design concept as well as a periodic maintenance program.

- Safety devices for plant worker protection
- Start/stop control devices for transportation and material handling machines
- Aeronautical/aerospace machines
- Control devices for nuclear reactors

Never use this product in applications where human safety may be put at risk.

NOTICE

Be sure that the user receives this manual before the product is used.

Copying or duplicating this user's manual in part or in whole is forbidden. The information and specifications in this manual are subject to change without notice.

Considerable effort has been made to ensure that this manual is free from inaccuracies and omissions. If you should find an error or omission, please contact Yamatake Corporation.

In no event is Yamatake Corporation liable to anyone for any indirect, special or consequential damages as a result of using this product.

©1998 Yamatake Corporation ALL RIGHTS RESERVED

The DIGITRONIK™ is a trademark of Yamatake Corporation in Japan.

SAFETY REQUIREMENTS



To reduce risk of electrical shock which could cause personal injury, follow all safety notices in this documentation.



This symbol warns the user of a potential shock hazard where hazardous live voltages may be accessible.

- If the equipment is used in a manner not specified by the manufacturer, the protection provided by the equipment must be impaired.
- Do not replace any component (or part) not explicitly specified as replaceable by your supplier.
- All wiring must be in accordance with local norms and carried out by authorized experienced personnel.
- The ground terminal must be connected before any other wiring (and disconnect last) .
- A switch in the main supply is required near the equipment.
- Mains power supply wiring requires a (T) 2 A, 250 V fuse(s) .

Over- voltage: Category II (IEC60364-4-443, IEC60664-1)

Specification of common mode voltage: The common mode voltages of all I/ O except for main supply are less than 33 Vrms, 46.7 V peak and 70 Vdc.

EQUIPMENT RATINGS

Supply voltages	85 to 264 ~
Frequency	50 / 60 Hz
Power or current ratings	25 VA maximum

EQUIPMENT CONDITIONS

Do not operate the instrument in the presence of flammable liquids or vapors. Operation of any electrical instrument in such an environment constitutes a safety hazard.

Temperature	0 to 50°C
Humidity	10 to 90 %RH
Vibration	Frequency 10 to 60 Hz Acceleration 2 m/s ² maximum

EQUIPMENT INSTALLATION

The controller must be mounted into a panel to limit operator access to the rear terminals.

CAUTION

Danger of explosion if battery is incorrectly replaced.

Replace only with the same or equivalent type recommended by the manufacturer.
Dispose of used batteries according to the manufacturer's instructions.

SAFETY PRECAUTIONS

■ About Icons

The safety precautions described in this manual are indicated by various icons. Please be sure you read and understand the icons and their meanings described below before reading the rest of the manual.

Safety precautions are intended to ensure the safe and correct use of this product, to prevent injury to the operator and others, and to prevent damage to property. Be sure to observe these safety precautions.



 **WARNING**

Warnings are indicated when mishandling this product might result in death or serious injury.





 **CAUTION**

Cautions are indicated when mishandling this product might result in minor injury to the user, or only physical damage to the product.









■ Examples

	Use caution when handling the product.
	The indicated action is prohibited.
	Be sure to follow the indicated instructions.









WARNING

	Be sure to turn off the power supply when you are installing or removing the controller. Failure to heed this warning may lead to electric shock.
	Do not disassemble the controller as this could lead to electric shock or malfunction.
	Connect the FG terminal to ground with a ground resistance of maximum 100Ω before connecting other equipment and external control circuits. Failure to do so may cause electric shock or fire.
	Be sure to turn off the power supply when you connect the controller. Failure to do so may lead to electric shock or fire.
	Do not touch a live part such as a power terminal. This may result in electric shock.

CAUTION

	Be sure to follow the operating requirements (regarding temperature, humidity, voltage, vibration, shock, mounting direction, atmosphere, etc.) as stated in the specifications of the controller. Failure to heed this caution may lead to fire or malfunction.
	Do not block ventilation openings. Failure to heed this caution may lead to fire or malfunction.
	Make sure that wire scraps, chips or water do not enter inside the case of the controller. Failure to heed this caution may lead to fire or malfunction.
	Do not use pointed objects such as mechanical pencils or pins to press the keys on the controller. This may result in malfunction.
	Connect the controller as specified using designated cables and connection procedures. Failure to heed this caution may lead to electric shock, fire or malfunction.
	Current applied to current input terminals (55), (56) and (58), (59) must meet the specified range. Failure to heed this caution may lead to fire or equipment breakdown.
	All terminal screws shall be tightened to specified torque. Improperly tightened screws may lead to electric shock or fire.
	Do not use unused terminals on the instrument as relay terminals for other equipment. Failure to heed this caution may lead to electric shock, fire or equipment breakdown.

CAUTION

	Attaching the terminal covers after completing the controller connections is highly recommended. Failure to heed this caution may lead to fire or malfunction. (Terminal covers are supplied with the controller.)
	Use Yamatake Corporation's SurgeNon if there is a risk of power surges caused by lightning. Failure to do so may cause fire or malfunction.
	Be sure to turn off the power supply when you are replacing the batteries. Failure to heed this warning may lead to electric shock.
	Be sure not to touch internal components during battery replacement or just after the power has been turned. This may result in burn injuries.
	<ul style="list-style-type: none">•Make sure that the batteries are inserted with the plus (+) and minus (–) poles correctly oriented.•Do not use damaged batteries or batteries that leak.•Do not throw batteries into a fire, recharge, disassemble or expose them to heat.•Store batteries in a cool, dry place. Failure to heed these cautions may result in burns or battery leakage.
	Batteries should be kept out of reach of children, since they may swallow them. Should a child swallow a battery, contact a doctor immediately.
	When disposing of used batteries at the user site, observe local bylaws.
	Before you touch internal components, be sure to discharge any static electricity on your body by touching a metal ground connector. Failure to heed this caution may lead to equipment damage.

Handling Precautions

After turning on the **DCP551** mark II, leave it for at least 10 seconds to let it stabilize before you start using it.

Organization of This User's Manual

This manual is organized as follows.

Chapter 1. PRODUCT OUTLINE

This chapter explains the use and features of the **DCP551** and provides the basic function block and product model numbers.

Chapter 2. NAMES AND FUNCTIONS OF PARTS

This chapter gives the names and functions of parts of the **DCP551**, and input type and range number.

Chapter 3. INSTALLATION AND MOUNTINGS

This chapter describes the procedure for mounting the **DCP551** onto an operation console.

We strongly urge persons responsible for device design on the **DCP551** read this chapter.

Chapter 4. WIRING

This chapter describes the wiring procedure and precautions required for installing the **DCP551**.

We strongly urge persons responsible for device design and wiring of the **DCP551** read this chapter.

Chapter 5. FUNCTIONS

This chapter explains detailed functions of the **DCP551**.

We strongly urge persons responsible for control design on the **DCP551** read this chapter.

Chapter 6. OPERATION

This chapter gives the selections of the basic display, program selection, operation, and other information.

We strongly urge persons responsible for device design and operation on the **DCP551** read this chapter.

Chapter 7. PARAMETER SETUP

This chapter describes the parameter setting method of the **DCP551** and the meaning of settings.

Chapter 8. PROGRAM SETUP

This chapter describes the program setting method of the **DCP551** and the meaning of settings.

Chapter 9. MEMORY CARD OPERATION

This chapter describes how to use memory cards.



NOTE

This chapter is not applicable to the **DCP551B******* model.

Chapter 10. TROUBLESHOOTING

This chapter describes checkpoints and countermeasures when the **DCP551** is not operating normally.

Chapter 11. SPECIFICATIONS

This chapter gives the general specifications, performance specifications and the external dimensions of the **DCP551**.

Contents

SAFETY REQUIREMENTS	
SAFETY PRECAUTIONS	
Organization of This User's Manual	
Conventions Used in This Manual	

Chapter 1. PRODUCT OUTLINE

1-1 Features	1-1
1-2 Basic Function Block Diagram.....	1-2
1-3 Data Configuration Overview	1-3
1-4 System Configuration	1-4
■ CPL communications network-based configuration	1-4
1-5 Model Number	1-5

Chapter 2. NAMES AND FUNCTIONS OF PARTS

2-1 Structure.....	2-1
2-2 Console.....	2-2
■ Basic display status	2-2
■ Display.....	2-2
■ Key pad	2-4
■ Key chord functions	2-6
■ Loader jack	2-7
2-3 Input Type and Range Number	2-8
■ Input	2-8

Chapter 3. INSTALLATION AND MOUNTING

3-1 Before Installation	3-1
■ Mounting position.....	3-1
■ Sources of electrical interference and countermeasures	3-2
■ Dust proof cover	3-2
3-2 Installation.....	3-3
■ Panel cutout dimension.....	3-3
■ Installation procedures	3-4

Chapter 4. WIRING

4-1 Precautions on Wiring.....	4-1
4-2 Recommended Cables.....	4-3
4-3 Making Terminal Connections	4-4
4-4 Terminal Array.....	4-5
4-5 Power Supply and Grounding	4-6

■ Power supply	4-6
■ Grounding	4-6
4-6 PV Input (Analog Input) Connection	4-7
■ PV input CH1 connection	4-7
■ PV input CH2 connection	4-7
4-7 Control Output Connection	4-9
■ Current output (5G, 5S)	4-9
■ Voltage output (6D)	4-9
■ Open collector output (8D).....	4-9
4-8 Auxiliary Output (Output CH1, CH2) Connection	4-10
■ Auxiliary output CH1 connection	4-10
■ Auxiliary output CH2 connection	4-10
4-9 Event Output (Open Collector Output) Connection.....	4-11
4-10 External Switch Input Connection.....	4-12
4-11 Communication Connection.....	4-13
■ RS-485 connection.....	4-13
■ RS-232C connection.....	4-16
■ Connection to ST221	4-17
4-12 Isolation During Input/Output.....	4-18

Chapter 5. FUNCTIONS

5-1 Data.....	5-1
■ Data types.....	5-1
5-2 Program Pattern	5-2
■ Pattern	5-2
■ Events	5-5
■ PID group selection.....	5-16
■ Selection of output limiter group	5-16
■ G.SOAK (Guarantee soak).....	5-17
■ PV shift	5-18
■ Repeat	5-19
■ PV start	5-20
■ Cycle.....	5-21
■ Pattern link	5-22
■ Tag.....	5-23
5-3 Mode	5-24
■ Mode types	5-24
■ Mode transitions.....	5-26
■ Mode transition operations	5-27
■ Mode transition restrictions	5-28
5-4 Controllers and Programmers.....	5-29
5-5 Input Process Functions	5-30
■ PV input 1 channel model.....	5-30
■ PV input 2 channel model.....	5-31
■ Channel switching (PV input 2 channel model).....	5-32
5-6 Output Processing Functions	5-37

■ Control output	5-37
■ SP output	5-39
■ Auxiliary output	5-39

Chapter 6. OPERATION

6-1 Power Supply On	6-1
6-2 Basic Display Selection	6-2
■ Program run mode displays	6-3
■ Constant value control mode	6-6
6-3 Selecting Programs	6-7
■ Selecting program numbers	6-7
6-4 External Switch Operation	6-8
■ External switch input	6-8
■ Selecting programs	6-9
■ Read timing	6-11
6-5 Manual Operation and Auto-Tuning	6-12
■ Manual operation	6-12
■ Auto-tuning (AT)	6-12

Chapter 7. PARAMETER SETUP

7-1 Parameter Setup	7-1
■ Selecting parameter settings groups	7-1
■ Progression of individual items in parameter settings	7-1
■ Modifying individual items and exiting the setting mode	7-2
7-2 Parameter Setting List	7-4
■ Variable parameter setting	7-5
■ Detailed information on variable parameters	7-9
■ Event configuration data settings	7-12
■ Settings by event type	7-13
■ PID parameter setting	7-18
■ Setup data setting	7-21
■ Detailed descriptions of setup data settings	7-28
■ Constant value control data setting	7-34

Chapter 8. PROGRAM SETUP

8-1 Program Setup	8-1
■ Selecting number of program to operate	8-1
■ Starting programming	8-2
■ State transition	8-2
■ Programming map	8-4
■ Display items	8-5
■ Setting pattern items	8-5

■	Setting event items	8-7
■	Setting PID groups and output limiter group number items	8-12
■	Setting G.SOAK (Guarantee soak) items.....	8-13
■	Setting PV shift items.....	8-14
■	Setting repeat items	8-15
■	Setting PV start items.....	8-16
■	Setting cycle items	8-17
■	Setting pattern link items	8-18
■	Setting tag items.....	8-19
■	Deleting programs.....	8-20
■	Inserting and deleting segments.....	8-21
8-2	Copying Programs	8-23
■	Program copy procedures.....	8-23

Chapter 9. MEMORY CARD OPERATIONS

9-1	Memory Card Type and Functions.....	9-1
9-2	Save Procedures.....	9-2
■	Save menu	9-2
■	Procedures for formatting cards	9-3
■	Procedures for saving single programs.....	9-3
■	Procedures for saving all programs	9-4
■	Procedures for saving setup data.....	9-4
■	Procedures for saving variable parameters.....	9-4
■	Procedures for saving PID parameters.....	9-5
■	Procedures for saving event configuration data	9-5
■	Procedures for saving all parameters.....	9-5
9-3	Load Procedures	9-6
■	Load menu.....	9-6
■	Card battery alarm panel.....	9-7
■	Procedures for loading individual programs.....	9-7
■	Procedures for loading all programs.....	9-8
■	Procedures for loading setup data.....	9-8
■	Procedures for loading variable parameters	9-8
■	Procedures for loading PID parameters.....	9-8
■	Procedures for loading event configuration data	9-9
■	Procedures for loading all parameters.....	9-9
9-4	Autoload.....	9-10
■	Key operated autoload procedure	9-10
■	Auto load using external switch inputs	9-11
9-5	Error Message List	9-12

Chapter 10. TROUBLESHOOTING

10-1 Self-Diagnostic Functions and Alarm Code Displays.....	10-1
■ Power ON self-diagnostic routines	10-1
■ Self-diagnostic routines performed each sampling cycle.....	10-1
■ Self-diagnostic routines performed continuously during operation ..	10-1
■ Alarm code display	10-2
■ Alarm classification.....	10-2
■ Display behavior and alarm code upon input burnout	10-2
10-2 Key Input Related Problemst	10-3
■ Normal display mode problems.....	10-3
■ Parameter setting related problems	10-6
■ Program setting related problems	10-6
10-3 When the BAT LED Flashes	10-8
■ BAT LED flashes.....	10-8
■ Replacing the battery	10-8

Chapter 11. SPECIFICATIONS

11-1 Specifications	11-1
■ Attachment/auxiliary devices list	11-7
11-2 External Dimensions	11-8
■ DCP551	11-8
■ Soft dust-proof cover set (optional).....	11-8

Program Work Sheet

Parameter Work Sheet

Index

Conventions Used in This Manual

The following conventions are used in this manual.

 **Handling Precautions**

: Handling Precautions indicate items that the user should pay attention to when handling the **DCP551**.

 **NOTE**

: Notes indicate useful information that the user might benefit by knowing.

(1), (2), (3)

: The numbers with the parenthesis indicate steps in a sequence or indicate corresponding parts in an explanation.

>>

: Indicates the result of an operation, details displayed on the personal computer or other devices, or the state of the device after operation.

DISP key, ↑ key

: Indicate this product's keys. These icons represent keys on the **DCP551**'s console.

FUNC+PROG key

: Combinations of icons like this indicate that **PROG key** must be pressed while holding **FUNC key** down.

PA01, C21

: Indicate the 7 segments display of display panel 1 and display panel 2 on this product.

PV SHIFT

: Indicates the display of the message display on this product.

Chapter 1. PRODUCT OUTLINE

1 - 1 Features

The **DCP551** is a general purpose single-loop control programmer for controlling temperature, pressure, flow rate and other parameters. The program provides a total of 99 patterns and up to 99 segments can be set for each pattern. Note, however, that the maximum number of segments is 2000 or less and that the maximum number of subfunctions for setting events is 4000 or less.

- **High accuracy in multi-range inputs**

Featuring a multi-range format, the user can select thermocouple, resistance temperature detector, DC voltage or DC current. Accuracy is $\pm 0.1\%$ FS ± 1 digit, the sampling cycles is 0.1 sec and some model numbers allow PV2 channel switching.

- **Multi-control output types**

Selection at setup allows the user to choose from among current proportional setting output, current proportional output, voltage time proportional output and open collector time proportional output.

- **Multi-communications**

Selection at setup enables the user to switch between RS-485 and RS-232C on the rear panel terminal base.

At setup it is also possible to switch the communications port from the rear panel terminal base to the front panel loader jack. A special cable is required to use to terminal base on the front panel.

- **Improved PLC support**

The programmer is equipped with 16 external switch inputs and 16 event outputs for flexible support of PLC based automatic systems.

- **Simple operation**

The optional plug-in memory card makes it easy to achieve program and parameter settings for later reuse. Also, the optional smart loader package allows you to make program and parameter settings from a PC.

1 - 2 Basic Function Block Diagram

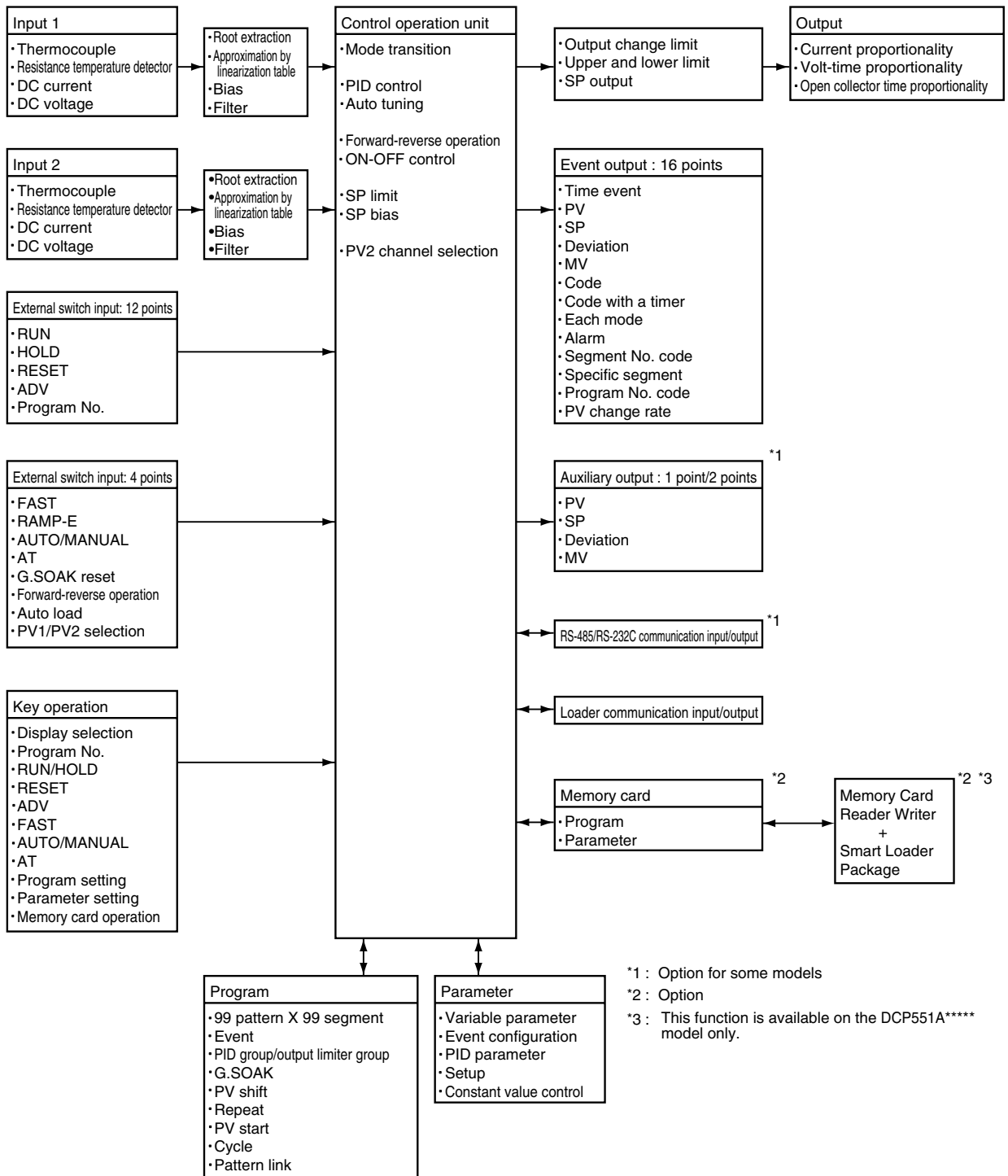

1 - 3 Data Configuration Overview

Data is comprised of parameters and the program.

Parameters are used to set the functions of the **DCP551** while the program is the software that operates the controller at run time.

- **A total of 99 patterns**

The program can record up to 99 patterns.

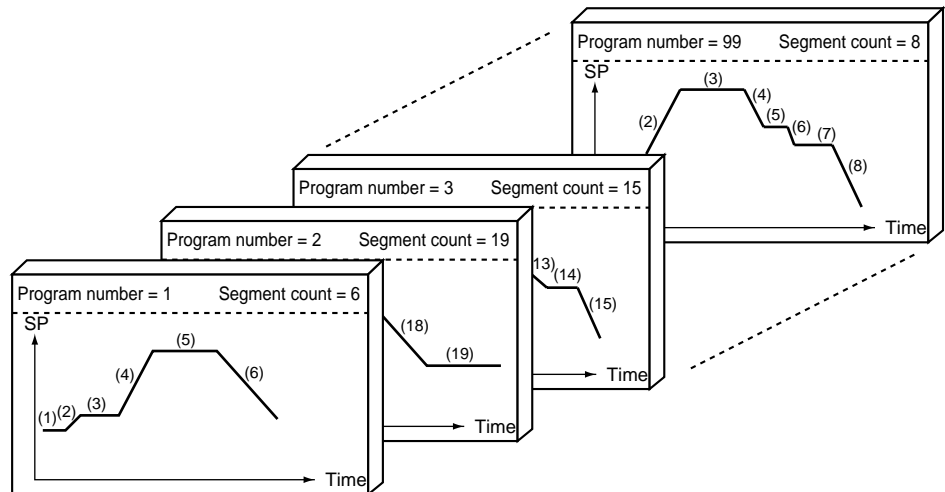

- **Parameters**

Five types of patterns are provided: variable parameters, event configuration data, PID parameters, setup data and constant value control data.

Variable parameter
Event configuration data
PID parameter
Setup data
Constant valule control data

1 - 4 System Configuration

■ CPL communications network-based configuration

Models equipped with the optional communications interface can be connected as a slaved DigitroniK's controller to a CPL communications* network. In this case, the user can employ as the master station the Yamatake Corporation FA Controller MA500 or the MX200 Machine Controller.

* : CPL(Controller Peripheral Link) Communications network is the Yamatake Corporation' s host- communications.

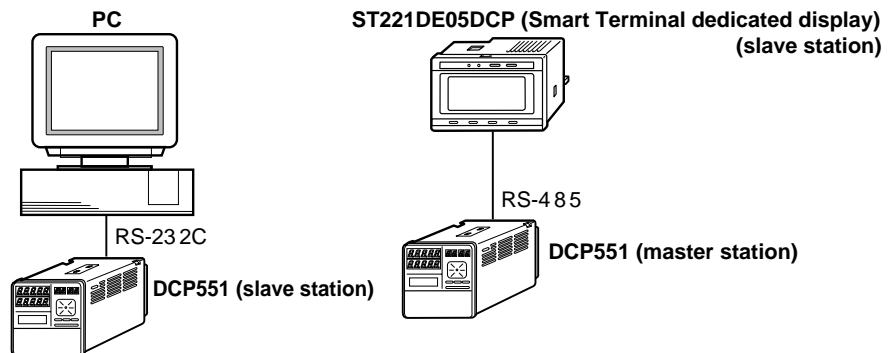
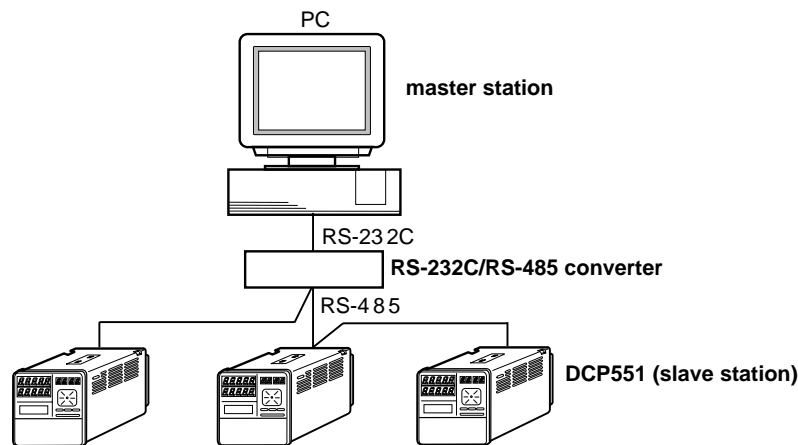
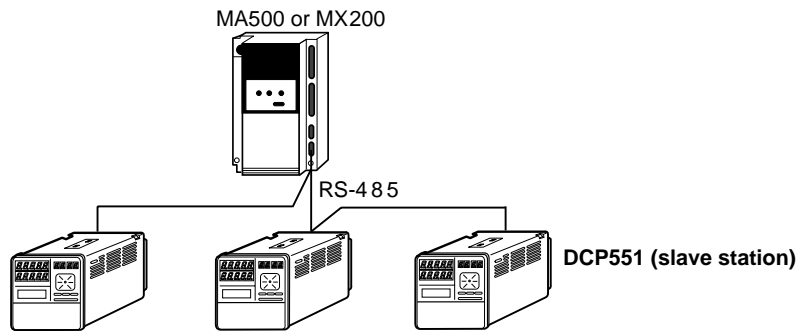

1 - 5 Model Number

Model number : **DCP551**0*****

Basic model number	Memory card	PV input count	Additional number	Option	Additional processing	Contents
	*	*	*	*	**	
DCP551						Digital programmable controller
	A					With memory card reader/writer
	B					Without memory card reader/writer
		1				PV input 1 channel
		2				PV input 2 channel
			0			Fixed 0
				0		Not provided
				1		Auxiliary output 1 channel
				2		Auxiliary output 2 channel, communication
					00	Not provided
					D0	Inspection certificate provided
					Y0	Complying with the traceability certification

Chapter 2. NAMES AND FUNCTIONS OF PARTS

2 - 1 Structure

The **DCP551** consists of a main unit, console, case, and terminal base.

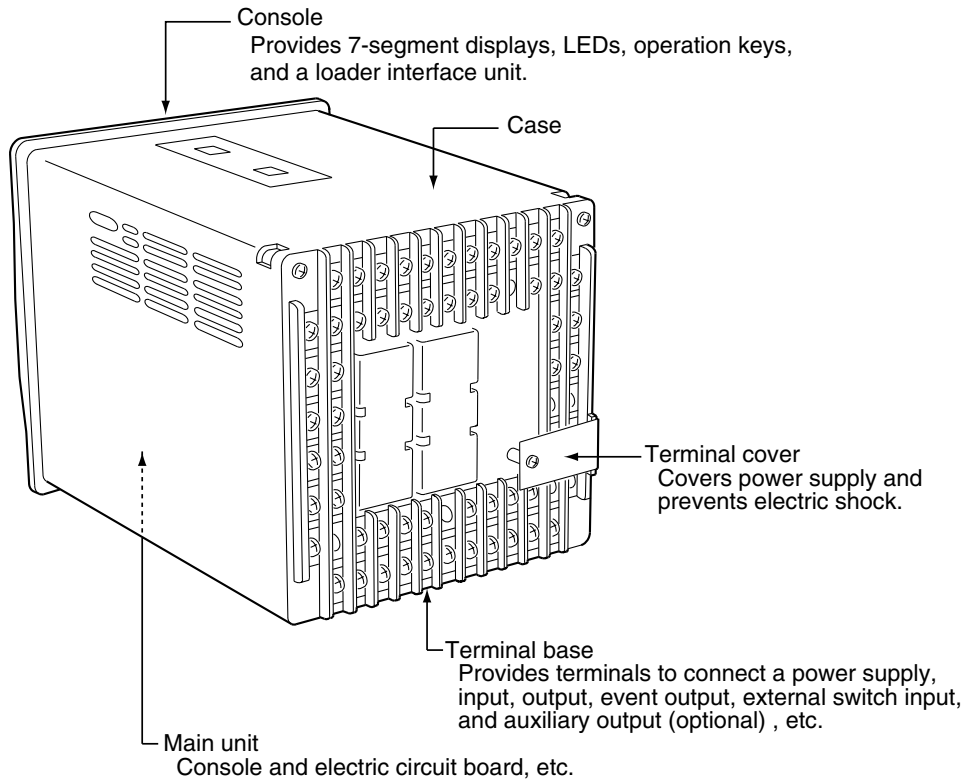

DCP551A model

DCP551B model

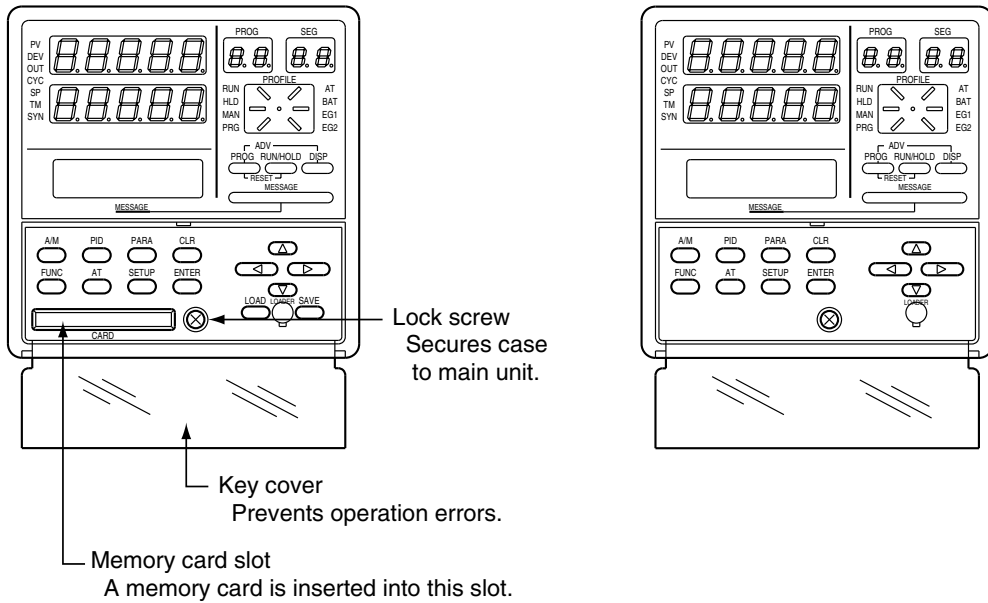

2 - 2 Console

The console consists of the operation keys, displays and LEDs (light emitting diodes).

■ Basic display status

Basic display status shows the running condition of the **DCP551** on the console. The basic display status is invoked when the **DCP551** is powered up (power on). Key operations make it possible to change from the basic display status to parameter setting status, program setting status, program copy status, memory card operation status* and general reset status.

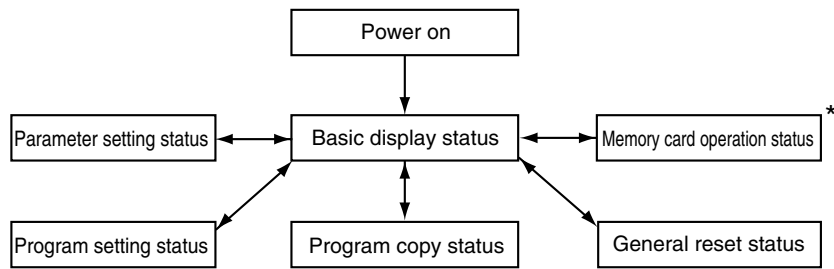

Key operations can also be used to return to the basic display status.

* : This function is available on the **DCP551A******* model only.

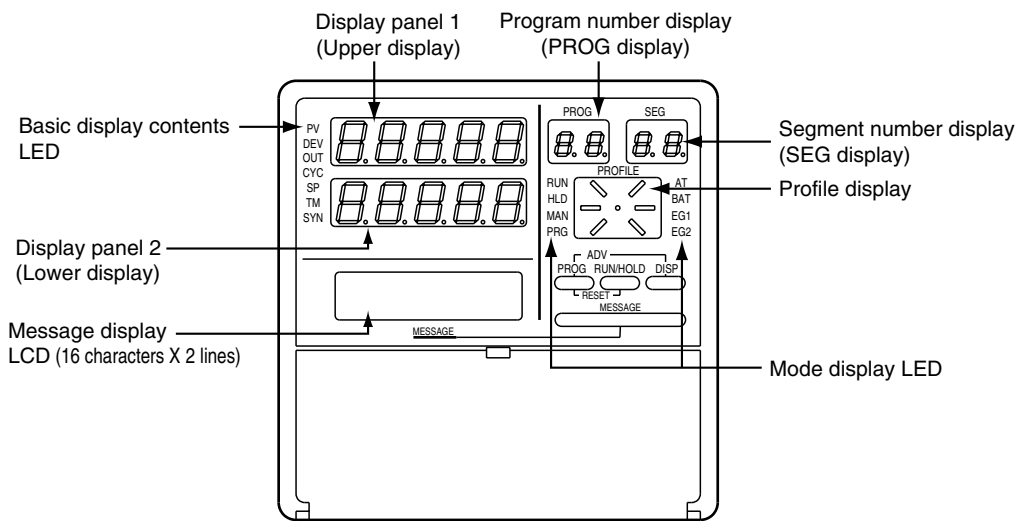

■ Display

● Basic display contents LED

- PV : Lights during PV display, otherwise off.
- DEV : Lights during deviation display, otherwise off.
- OUT : Lights during output display, otherwise off.
- CYC : Lights during cycle display, otherwise off.
- SP : Lights during SP display, otherwise off.
- TM : Lights during time display, otherwise off.
- SYN : Off

- **Display panel 1**
 Indicates PV and other data in basic display status.
 Indicates item codes in parameter setting status.
 Indicates set values and item codes in program setting status.
- **Display panel 2**
 Indicates SP, time, output and other data in basic display status.
 Indicates set values in parameter setting status.
 Indicates set values in program setting status.
- **Message display**
 Indicates output graph, deviation graph, running progress graph, event status, program tag and other data in basic display status.
 Displays reference messages in parameter setting status.
 Displays tag settings and reference messages in program setting status.
 Indicates selected operation and operation results during memory card operation.
- **Program number display**
 Indicates a selected program number in basic display status.
 Indicates a set program number in program setting status.
 Off during constant value control.
 Indicates the alarm code “AL” when an alarm occurs in basic display status.
- **Segment number display**
 Indicates a selected segment number in basic display status.
 Indicates a set segment number in program setting status.
 Off during constant value control.
 Indicates an alarm code number when an alarm occurs in basic display status.
- **Mode display LED**
 RUN, HLD : Indicates the RUN, HOLD, FAST, END, and READY FAST modes (see the table below).

LED \ Mode	READY	RUN	HOLD	FAST	END	READY FAST
RUN	OFF	Lights	OFF	Flicker	OFF	Lights
HLD	OFF	OFF	Lights	OFF	Flickers	Lights

- MAN : Lights in MANUAL mode. Off in AUTO mode.
- PRG : Lights in program setting status, otherwise off.
- AT : Flickers during auto tuning execution, otherwise off.
- BAT : Flickers when battery voltage is too low, otherwise off.
- EG1, EG2 : Lights when an event number output set by PA41 or PA42 is set to ON setting. Off when set to OFF.

- **Profile display**
 Indicates the rising, soaking, and falling trends of a program pattern.
 Flickers during G.SOAK wait and lights continuously after power on.

■ Key pad

CAUTION



Do not use pointed objects such as mechanical pencils or pins to press the keys on the controller. This may result in malfunction.

DCP551A model

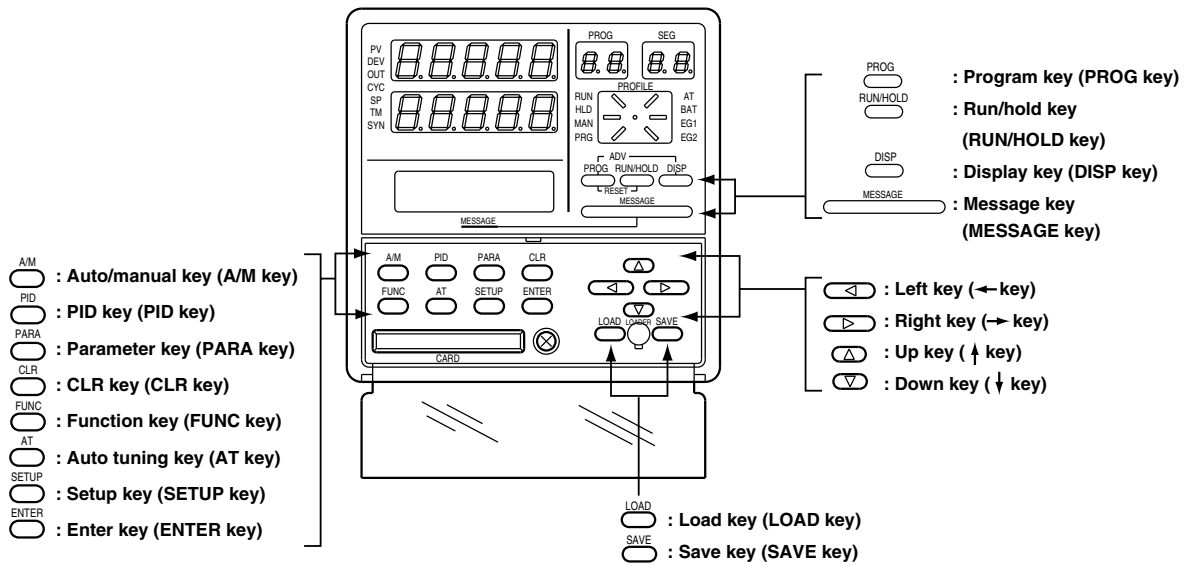

() : Denotes key term used in this manual.

DCP551B model

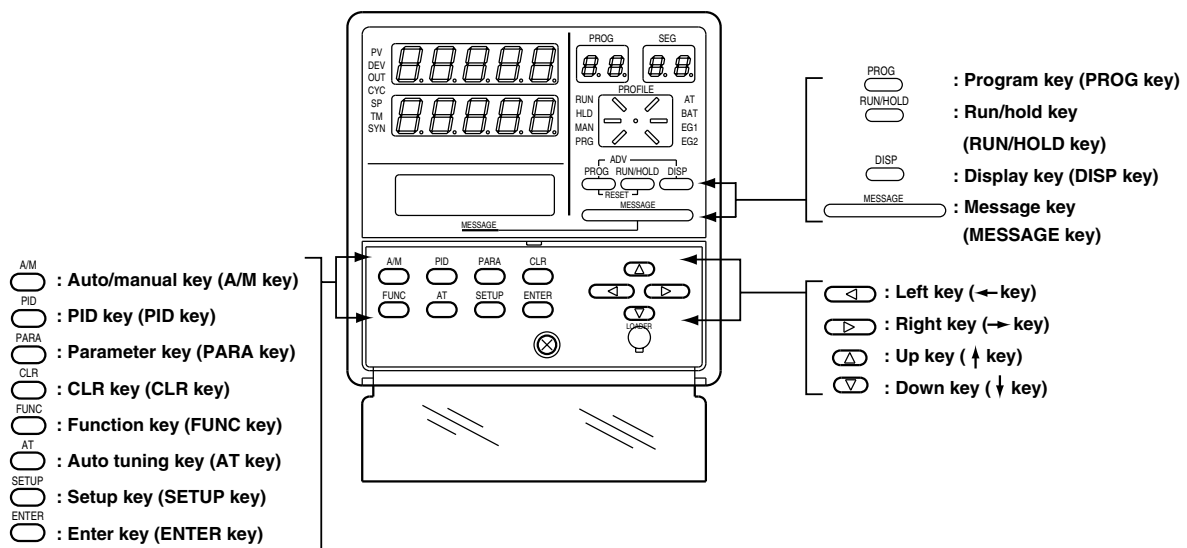

() : Denotes key term used in this manual.

Classification	Function	Key operation
Basic display status	Changes the display contents.	DISP
	Changes the display contents on the message display.	MESSAGE
	Changes set program numbers in ascending order. (In READY mode)	PROG
	Performs RUN operation. (In READY, HOLD, FAST, or READY FAST mode)	RUN/HOLD
	Performs HOLD operation. (In RUN mode)	
	Performs RESET operation. (In RUN, HOLD, FAST, END, or READY FAST mode)	PROG + RUN/HOLD
	Performs ADV operation. (In RUN, HOLD, FAST, or READY FAST mode)	PROG + DISP
	Performs FAST operation. (In RUN, HOLD, or READY mode)	FUNC + →
	Performs MANUAL operation. (In AUTO mode)	A/M
	Performs AUTO operation. (In MANUAL mode)	
	Starts auto tuning. (When auto tuning is not in operation.)	AT
	Interrupts auto tuning (When auto tuning is in operation.)	
	Changes numerics during MANUAL operation. (When the MV or SV display flickers.)	↑ ↓ ← →
Changes program numbers or segment numbers. (When the program number or segment number flickers.)		
Parameter setting	Starts the variable parameter setting. (In basic display status)	PARA
	Starts the event configuration setting. (In basic display status)	FUNC + PARA
	Starts the PID parameter setting. (In basic display status)	PID
	Starts the setup setting. (In basic display status)	SETUP
	Starts the fixed command control setting. (In basic display status)	FUNC + PID
	Shifts each item.	↑ ↓ ← →
	Enters set values.	
	Completes a change in a set value. (When a set value flickers.)	↑ ↓ ← →
	Changes each item s set point. (When a set value flickers.)	
	Stops each item s set point. (When a set value flickers.)	
	Ends parameter setting.	DISP
Program setting	Starts the program setting (programming). (In basic display status)	FUNC + PROG
	Shifts to program item or segment number.	↑ ↓ ← →
	Enters set values.	
	Completes a change in a set values. (When a set value flickers.)	↑ ↓ ← →
	Changes each item s set point. (When a set value flickers.)	

Classification	Function	Key operation
Program setting	Erases or resets a set value. (When a set value flickers.)	FUNC + CLR
	Cancels change in set value. (When a set value flickers.)	DISP
	Inserts or delete a segment when a pattern SP setting is started.	FUNC + ENTER
	Changes RAMP-X ↔ RAMP-T or RAMP-X ↔ RAMP-E when a pattern SP setting is completed.	
	Starts a program number change.	FUNC + PROG
	Ends program setting.	DISP
Program copy	Starts program copy. (In basic display status)	↑ + PROG
	Changes program number at copy destination.	↑ ↓
	Executes the copy. (When a set value flickers.)	ENTER
	Ends program copy.	DISP
Memory card operation (available on the DCP551A***** model only)	Starts a data write operation to the memory card. (In basic display status)	SAVE
	Writes data to the memory card.	
	Starts a data read operation from the memory card. (In basic display status)	LOAD
	Reads data from the memory card.	
	Changes selected memory card operation.	↑ ↓
	Enters memory card operation.	ENTER
	Interrupts memory card operation.	DISP
General reset	Returns a check status of the general reset. (In basic display status)	FUNC + CLR + MESSAGE
	Executes a general reset.	ENTER
	Interrupts a general reset.	DISP

■ **Key chord functions**

PROG + RUN/HOLD : Reset key
 Press the **RUN/HOLD key** while holding down the **PROG key** in basic status display to perform a RESET.
 The READY mode is invoked when a reset is performed in the RUN, HOLD, FAST, END, or READY FAST modes. This RESET operation does not work in the READY mode.

PROG + DISP : Advance key
 Press the **DISP key** while holding down the **PROG key** in the program run mode in basic status display to perform an ADV (advance) operation. The next segment is displayed when this action is performed in the RUN, HOLD, FAST, END, or READY FAST modes. This ADV operation does not work in the READY mode.

FUNC + → : Fast key
 Press the **→ key** while holding down the **FUNC key** in the program run mode in basic status display to perform a FAST operation.
 The system changes from the RUN or HOLD mode to the FAST mode. If the system is in the READY mode, it goes to the READY FAST mode.

-
- FUNC + PARA** : Event configuration setting key
Press the **PARA key** while holding down the **FUNC key** in basic status display to switch to the event configuration setting status.
- FUNC + PID** : Constant value control setting key
Press the **PID key** while holding down the **FUNC key** in basic status display to switch to the constant value control setting status.
- FUNC + PROG** : Program setting (programming) key
Press the **PROG key** while holding down the **FUNC key** in the program run mode in basic status display to go to the program setting (programming) status. When the **PROG key** is pressed while holding down the **FUNC key** in the program setting status, allows you to change the number of the program to be set.
- FUNC + CLR** : Program delete key
Press the **CLR key** while holding down the **FUNC key** during registration in the program setting status to delete a setting or return to a default value.
- FUNC + ENTER** : Segment insert/remove/RAMP/selection key
Press the **ENTER key** while holding down the **FUNC key** to go to the segment insert/delete panel during SP and time setting in the program setting status.
Pressing the **ENTER key** while the **FUNC key** is held down during SP registration in the program setting status allows you to switch between RAMP-X and RAMP-T as well as RAMP-X and RAMP-E.
- ↑ + PROG** : Program copy key
Press the **PROG key** while holding down the **↑ key** in program run READY mode in basic display status to go to the program copy panel.
- FUNC + CLR + MESSAGE** : General reset key
Press the **CLR** and **MESSAGE keys** simultaneously while holding down the **FUNC key** in the READY AUTO mode in the basic display status to go to the general reset verification panel.

■ Loader jack

This jack allows the connection of a loader.
Do not insert plugs other than loader plugs.
The terminal base is not isolated from internal digital circuits.
When not in use, always replace the cap.

2 - 3 Input Type and Range Number

■ Input

● Thermocouple

Input type			Input range (FS)		Accuracy (under standard conditions)	
Symbol	Code	Range No.	°C	°F		
K (CA)	K46	16	-200.0 to +200.0	-300.0 to +400.0	±0.1%FS	
K (CA)	K09	0	0.0 to 1200.0	0 to 2400	±0.1%FS	
K (CA)	K08	1	0.0 to 800.0	0 to 1600	±0.1%FS	
K (CA)	K04	2	0.0 to 400.0	0 to 750	±0.1%FS	
E (CRC)	E08	3	0.0 to 800.0	0 to 1800	±0.1%FS	
J (IC)	J08	4	0.0 to 800.0	0 to 1600	±0.1%FS	
T (CC)	T44	5	-200.0 to +300.0	-300 to +700	±0.1%FS	±0.3%FS at -200 to -45°C
B (PR13)	B18	6	0.0 to 1800.0	0 to 3300	±0.1%FS	±4.0%FS at 0 to 260°C, ±0.15%FS at 260 to 800°C
R (RR13)	R16	7	0.0 to 1600.0	0 to 3100	±0.1%FS	
S (PR10)	S16	8	0.0 to 1600.0	0 to 3100	±0.1%FS	
W (WRe5-26)	W23	9	0.0 to 2300.0	0 to 4200	±0.1%FS	
W (WRe5-26)	W14	10	0.0 to 1400.0	0 to 2552	±0.1%FS	
PR40-20	D19	11	0.0 to 1900.0	0 to 3400	±0.2%FS	±0.9%FS at 0 to 300°C, ±0.5%FS at 300 to 800°C
N	U13	12	0.0 to 1300.0	32 to 2372	±0.1%FS	
PL II	Y13	13	0.0 to 1300.0	32 to 2372	±0.1%FS	
Ni-Ni • Mo	Z13	14	0.0 to 1300.0	32 to 2372	±0.1%FS	
Gold, iron, chromel	Z06	15	0.0 to 300.0K (K : Kelvin)		±0.4%FS	

● Resistance temperature detector (RTD)

Input type			Input range (FS)		Accuracy (under standard conditions)	
Symbol	Code	Range No.	°C	°F		
JIS'89Pt100 (IEC Pt100 Ω)	F50	64	-200.0 to +500.0	-300.0 to +900.0	±0.1%FS	
	F46	65	-200.0 to +200.0	-300.0 to +400.0	±0.1%FS	
	F32	66	-100.0 to +150.0	-150.0 to +300.0	±0.1%FS	
	F36	67	-50.0 to +200.0	-50.0 to +400.0	±0.1%FS	
	F33	68	-40.0 to +60.0	-40.0 to +140.0	±0.15%FS	
	F01	69	0.0 to 100.0	0.0 to 200.0	±0.15%FS	
	F03	70	0.0 to 300.0	0.0 to 500.0	±0.1%FS	
	F05	71	0.0 to 500.0	0.0 to 900.0	±0.1%FS	
JIS'89Pt100	P50	96	-200.0 to +500.0	-300.0 to +900.0	±0.1%FS	
	P46	97	-200.0 to +200.0	-300.0 to +400.0	±0.1%FS	
	P32	98	-100.0 to +150.0	-150.0 to +300.0	±0.1%FS	
	P36	99	-50.0 to +200.0	-50.0 to +400.0	±0.1%FS	
	P33	100	-40.0 to +60.0	-40.0 to +140.0	±0.15%FS	
	P01	101	0.0 to 100.0	0.0 to 200.0	±0.15%FS	
	P03	102	0.0 to 300.0	0.0 to 500.0	±0.1%FS	
	P05	103	0.0 to 500.0	0.0 to 900.0	±0.1%FS	

● DC current, DC voltage

Input type			Input range (FS)		Accuracy (under standard conditions)	
Symbol	Code	Range No.				
mA (Linear)	C01	48	4 to 20mA	Programmable range -19999 to +20000 (Decimal point position is variable.)	±0.1%FS	
	Z51	52	2.4 to 20mA		±0.1%FS	
mV	M01	49	0 to 10mV		±0.1%FS	
	L02	50	-10 to +10mV		±0.1%FS	
		51	0 to 100mV		±0.1%FS	
mA (Linear)	C01	128	4 to 20mA		±0.1%FS	
	Z51	134	2.4 to 20mA		±0.1%FS	
V (Linear)		129	0 to 1V		±0.1%FS	
		130	-1 to +1V		±0.1%FS	
	V01	131	1 to 5V		±0.1%FS	
		132	0 to 5V	±0.1%FS		
		133	0 to 10V	±0.1%FS		

! Handling Precautions

- The unit for code Z06 is "K" (kelvin).
- Code F50 and P50 do not generate the PV lower bound alarm.
- The number of decimal digits for DC current and DC voltage is programmable from 0 to 4.
- The lower limit readout of code B18 is 20°C (68°F).

Chapter 3. INSTALLATION AND MOUNTING

3 - 1 Before Installation

WARNING



Be sure to turn off the power supply when you are installing or removing the controller.

Failure to heed this warning may lead to electric shock.



Do not disassemble the controller as this could lead to electric shock or malfunction.

CAUTION



Be sure to follow the operating requirements (regarding temperature, humidity, voltage, vibration, shock, mounting direction, atmosphere, etc.) as stated in the specifications of the controller.

Failure to heed this caution may lead to fire or malfunction.



Do not block ventilation openings.

Failure to heed this caution may lead to fire or malfunction.



Make sure that wire scraps, chips, or water do not enter inside the case of the controller.

Failure to heed this caution may lead to fire or malfunction.

■ Mounting position

Do not install the **DCP551** in locations:

- exposed to high or low temperature or humidity.
- exposed to direct sunlight or to the elements such as outside.
- exposed to water, oil or chemicals.
- exposed to corrosive or inflammable gas.
- exposed to dust or smoke.
- exposed to vibrations or shocks.
- exposed to strong electric or magnetic fields.
- exposed to electric noise such as ignition devices or welding machines.

■ Sources of electrical interference and countermeasures

- The following noise generation sources are generally presumable.
 - (1) Relays and contacts
 - (2) Solenoid coils and valves
 - (3) Power lines (especially those carrying more than 90Vac)
 - (4) Inductive loads
 - (5) Inverters
 - (6) Motor rectifiers
 - (7) Phase angle control SCR
 - (8) Wireless communications equipment
 - (9) Welding machines
 - (10) High voltage ignition devices
- If the source of noise cannot be removed, take the following measures.
 - Use a CR filter to suppress fast-rising noise.
Recommended CR filter : Yamatake Corporation model No. 81446365-001
 - Use a varistor to suppress high-amplitude interference.
Recommended varistors : Yamatake Corporation model No. 81446366-001 (for 100V)
81446367-001 (for 200V)

Handling Precautions

Varistors must be handled carefully as they become defective if they are short-circuited.

■ Dust proof cover

Use the soft dust proof cover when the **DCP551** is used in locations where there is a lot of dust.

See Section “Soft dust-proof cover set (optional)” on page 11-8 for details.

3 - 2 Installation

This section describes installation procedures.

■ Panel cutout dimension

Use 2 mm thick steel panels in setting up the **DCP551**.

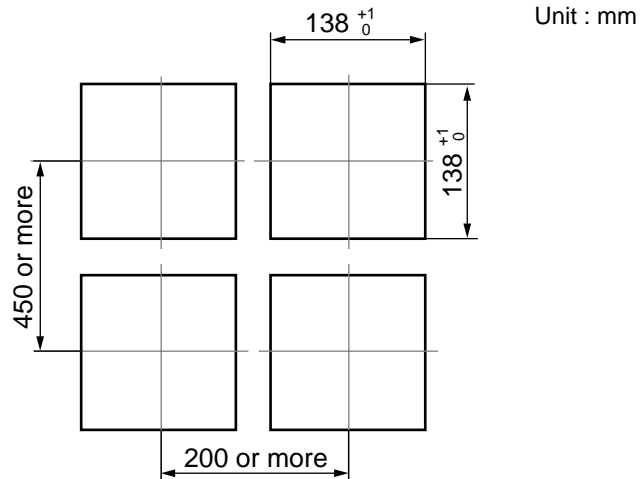

! Handling Precautions

Install the **DCP551** in a location where the lower panel is not exposed to temperatures that exceed the operating temperature range (0 to 50°C). Make sure that the temperatures above and below the controller meet specified requirements.

■ Installation procedures

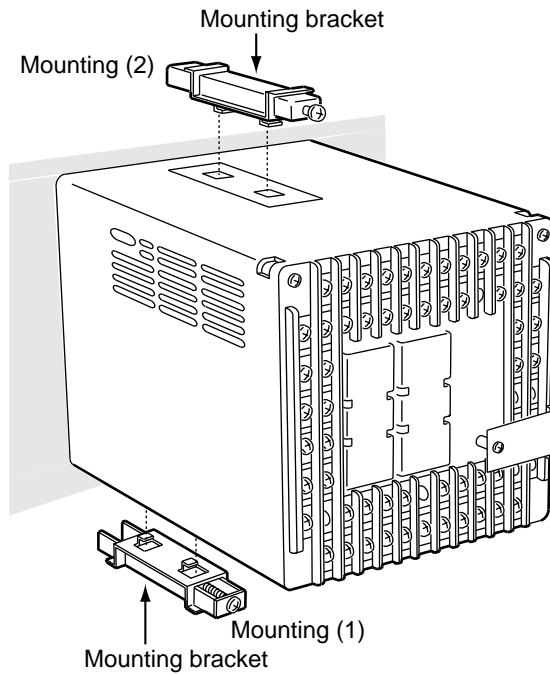

- Use the provided mounting bracket to firmly secure the upper and lower panels.
- Assemble the instrument before carrying out mounting (1).

! Handling Precautions

When the provided mounting brackets are firmly secured and there is no looseness, turn the screws only one full turn. Over-tightening the screws of the brackets can deform or damage the case.

- The rear of the instrument must not be more than 10° above or below the horizontal plane.

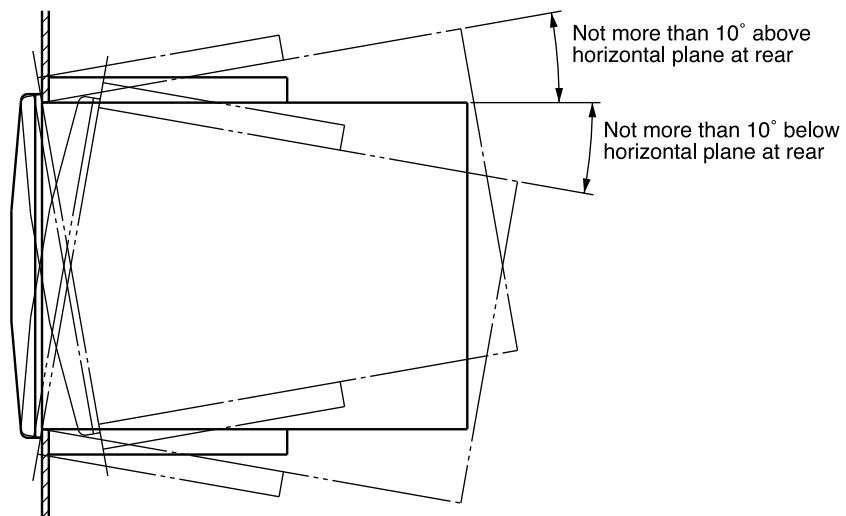

Chapter 4. WIRING

4 - 1 Precautions on Wiring

WARNING



Connect the FG terminal to ground with a ground resistance of maximum 100Ω before connecting other equipment and external control circuits. Failure to do so may cause electric shock or fire.



Be sure to turn off the power supply when you connect the controller. Failure to do so may lead to electric shock or fire.



Do not touch a live part such as a power terminal. This may result in electric shock.

CAUTION



Connect the controller as specified using designated cables and connection procedures. Failure to heed this caution may lead to electric shock, fire or malfunction.



Make sure that wire scraps, chips or water do not enter inside the case of the controller. Failure to heed this caution may lead to fire or malfunction.



Current applied to current input terminals (55), (56) and (58), (59) must meet the specified range. Failure to heed this caution may lead to fire or equipment breakdown.



All terminal screws shall be tightened to specified torque. Improperly tightened screws may lead to electric shock or fire.



Do not use unused terminals on the instrument as relay terminals for other equipment. Failure to heed this caution may lead to electric shock, fire or equipment breakdown.



Attaching the terminal covers after completing the controller connections is highly recommended. Failure to heed this caution may lead to fire or malfunction. (Terminal covers are supplied with the controller.)



Use Yamatake Corporation's SurgeNon if there is a risk of power surges caused by lightning. Failure to do so may cause fire or malfunction.

Handling Precautions

- Before connecting the lines, verify the model number and terminal numbers on the label affixed to the side panel of the **DCP551**. After completing, always double check to ensure all wiring has been performed correctly before turning on the power.
- The I/O signal lines and the communications lines shall maintain at least 50cm between them and the power supply line and power supply cables. Do not route these cables through the same conduit or duct.
- Make sure that no crimp-style solderless wire connectors are touching an adjacent terminal or connector.
- When connecting a thermocouple input of the **DCP551** to another instrument, make sure the instrument's input impedance totals at least 1M Ω . If less than 1M Ω , the **DCP551** may not be able to detect sensor disconnection.
- Cautions when using data input devices in combination
Input of the **DCP551** input or output (connected in parallel for input) to an A/D converter, analog scanner, etc., may cause dispersion of the read data. To prevent such occurrence, take one of the following corrective measures.
 - (1) Use a low-speed integral A/D converter.
 - (2) Insert an isolator with no switching power supply between the **DCP551** and the A/D converter.
 - (3) Perform averaging with a personal computer when the data is read.
 - (4) If the device permits, insert an input filter.
- Devices and systems to be connected to this must have the basic insulation sufficient to with stand the maximam operating voltage levels of the power supply and input/output parts.

4 - 2 Recommended Cables

To perform thermocouple input, connect a thermocouple element to the terminals. When the wiring distance is long or when connecting the thermocouple without the element to the terminals, connect via shielded compensating lead wires.

NOTE

- For I/O other than thermocouple, use JCS4364 instrument cable or equivalent (is commonly called twisted shielded cable for instrument use).

The following cable are recommended.

Fujikura Ltd.	2-wire	IPEV-S-0.9mm ² × 1P
	3-wire	ITEV-S-0.9mm ² × 1T
Hitachi Cable Ltd.	2-wire	KPEV-S-0.9mm ² × 1P
	3-wire	KTEV-S-0.9mm ² × 1T

- A shielded multicore microphone cord (MVVS) may be used, if electromagnetic induction is comparatively low.

4 - 3 Making Terminal Connections

To connect a line to the terminals, use crimp-style solderless wire connectors that fit an M3.5 screw.

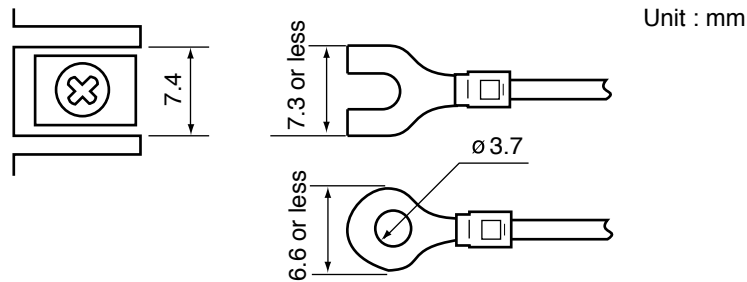

! Handling Precautions

- If the **DCP551** is mounted in a location subject to noticeable vibration or impact, be sure to use round crimp-style solderless wire connectors to prevent lines from becoming disconnected from the terminals.
- Be careful not to allow any of the crimp-style solderless wire connectors to touch adjacent terminals or connectors.
- The terminal screws shall be tightened to 0.78 to 0.98 N·m torque.

4 - 4 Terminal Array

Wires are connected to the terminal base according to the layout shown below.

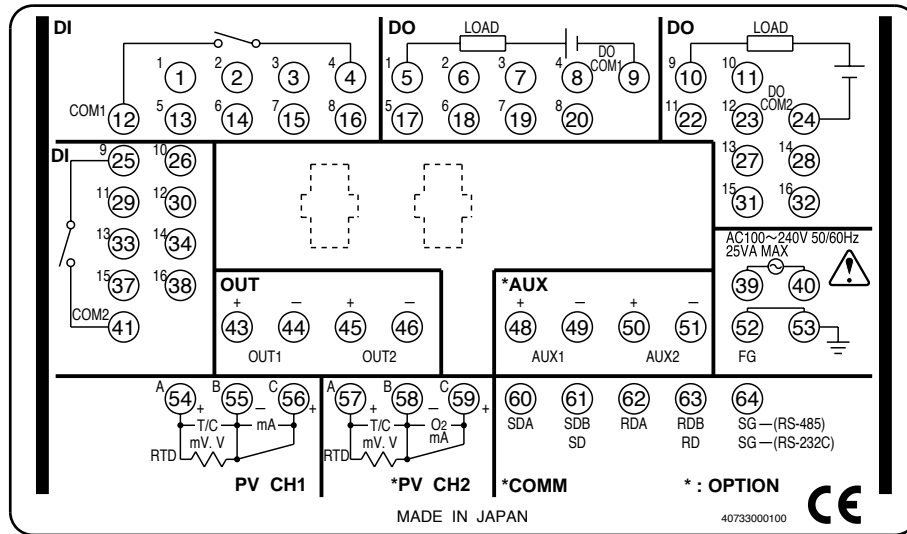

4 - 5 Power Supply and Grounding

■ Power supply

To supply power to the **DCP551**, use an instrument-dedicated single-phase power supply subject to minimal electrical interference.

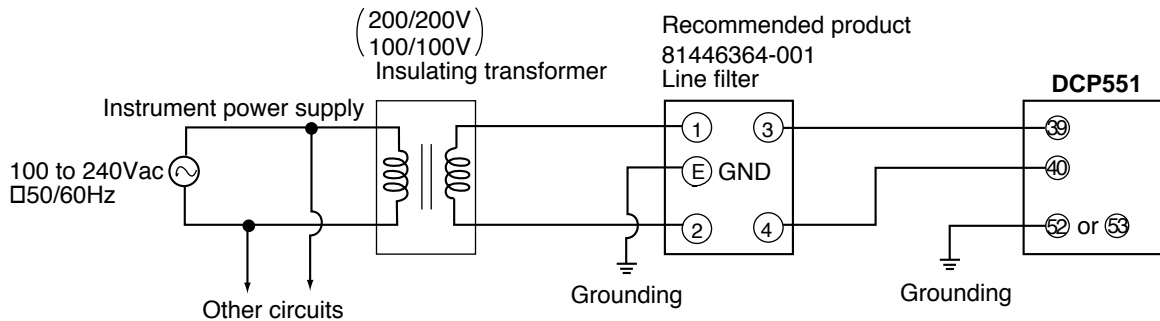

! Handling Precautions

- If electrical interference proves excessive, we recommend adding an insulating transformer and/or using a line filter.
Yamatake Corporation model no.: 81446364-001
- After carrying out interference reducing measures, do not bundle the primary and secondary power supply coils together or insert them in the same conduit or duct.

■ Grounding

If grounding the shield wire or other lines proves difficult, ground them separately to a grounding terminal block.

Ground resistance : Less than 100Ω

Conductor : Annealed copper wire, min. 2mm² (AWG14)

Max. Length : 20m

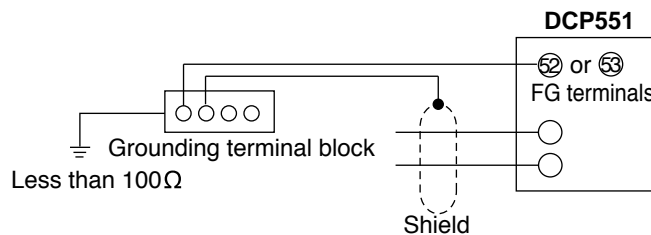

! Handling Precautions

To ground the **DCP551**, connect the FG terminal (terminal (52) or (53)) to a single ground point without jumpering.

4 - 6 PV Input (Analog Input) Connection

⚠ CAUTION



Current applied to current input terminals (55), (56) and (58), (59) must meet the specified range.
Failure to heed this caution may lead to fire or equipment breakdown.

■ PV input CH1 connection

PV input CH1 is a multi-input type input for sensors. Connect as shown below, according to the type of sensor being used.

• Thermocouple input

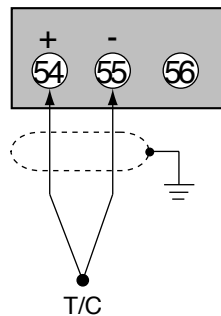

• Resistance temperature detector input

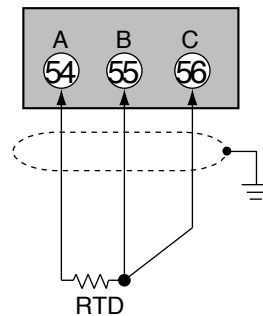

• DC voltage input

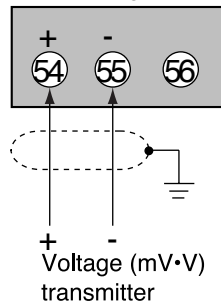

• DC current input

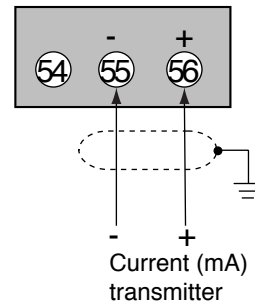

■ PV input CH2 connection

PV input CH2 is a multi-input type input for sensors. Connect as shown below, according to the type of sensor being used.

• Thermocouple input

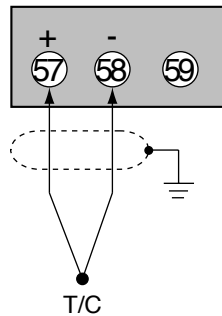

• Resistance temperature detector input

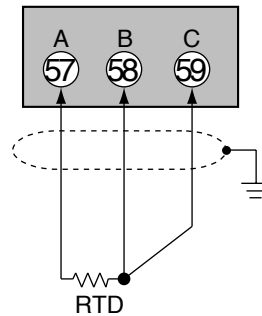

•DC voltage input

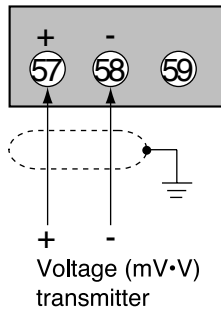

•DC current input

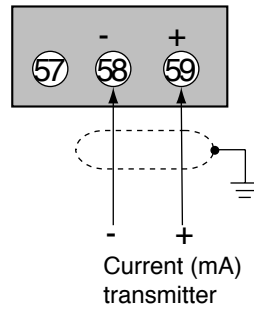

! Handling Precautions

- Be careful to connect the input polarities correctly.
- Use shielded cable to connect the input.

4 - 7 Control Output Connection

! WARNING



Be sure to turn off the power supply when you are installing or removing the controller. Failure to do so may cause electric shock or fire.

■ Current output (5G, 5S)

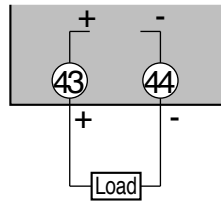

4 to 20mAdc
Load resistance less than 600Ω

■ Voltage output (6D)

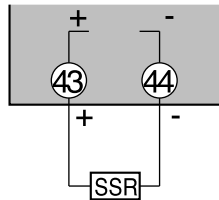

2 to 22mAdc
With current value adjustment function
(Setup data C95)

! Handling Precautions

The voltage output is a constant current circuit inside. The SSR used is set to an optimum voltage to meet the requirements of the load. Enter the value in the setup data. A normal SSR voltage has been set at the factory before shipment.

■ Open collector output (8D)

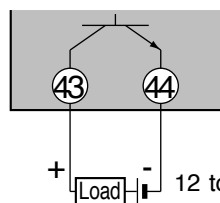

Max. load current : 100mA
Leakage current when off : less than 0.1mA

! Handling Precautions

- Do not short-circuit the positive (+) terminal of the external power supply to terminal (43) on the **DCP551**. Doing so causes the open collector outputs to malfunction. (There is no short circuit preventing circuit inside.)
- When connecting a semiconductor load such as a programmable controller (sequencer), select a module in which the current directions match.
Use one made inoperative by the leakage current produced when the digital outputs are shut off.

4 - 8 Auxiliary Output (Output CH1, CH2) Connection

WARNING



Be sure to turn off the power supply when you connect the controller.
Failure to do so may lead to electric shock or fire.

■ Auxiliary output CH1 connection

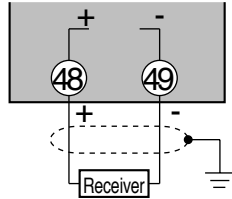

4 to 20mA_{dc}
Load resistance less than 600Ω

■ Auxiliary output CH2 connection

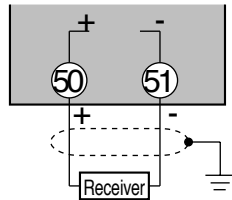

4 to 20mA_{dc}
Load resistance less than 600Ω

4 - 9 Event Output (Open Collector Output) Connection

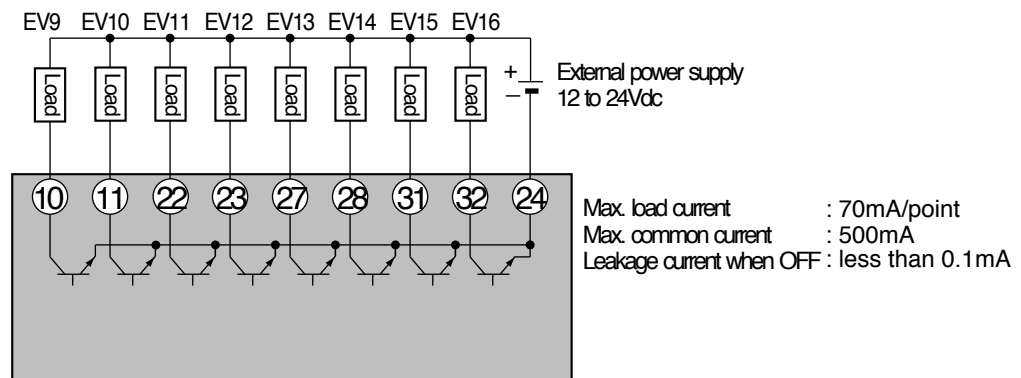
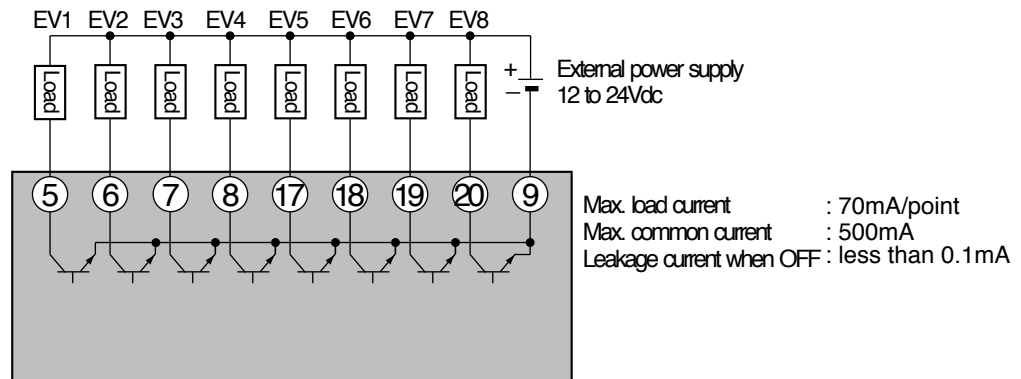

! Handling Precautions

- Do not short-circuit the positive (+) terminal of the external power supply to terminals (5) to (8), (17) to (20), (10), (11), (22), (23), (27), (28), (31), and (32) on the **DCP551**. Doing so causes the open collector outputs to malfunction. (There is no short circuit preventing circuit inside.)
- When connecting a semiconductor load such as a programmable controller (sequencer), select a module in which the current directions match.
Use one made inoperative by the leakage current produced when the digital outputs are shut off.

4 - 10 External Switch Input Connection

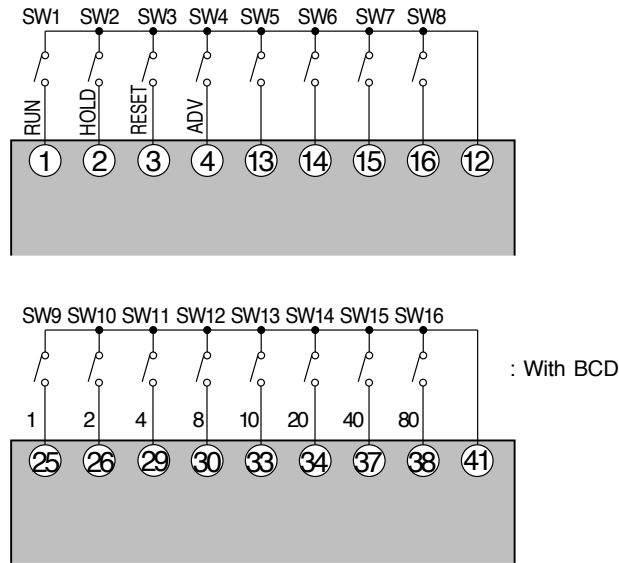

● Internal circuit diagram of the DCP551 connecting external switch input

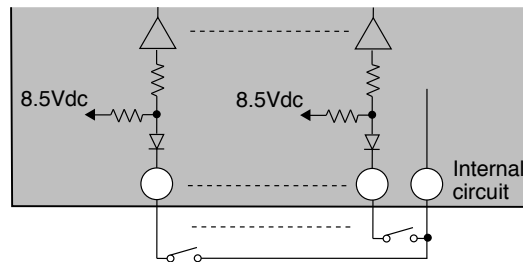

! Handling Precautions

- The inputs of the **DCP551** unit are provided with a built-in power supply (open voltage type, 8.5Vdc). Always use no-voltage contacts externally.
- For the no-voltage contacts, use gold contacts or other relays that switch on small currents. Other types of relay contacts may not switch. Use contacts that have ample margin over the minimum switching capacity with respect to the current and open voltage ratings of contacts provided on the **DCP551**.
- If using semiconductors (open collectors, etc.) as no-voltage contacts, use one that maintains a potential of no more than 2V across the contacts when actuated, and a leakage current of no more than 0.1mA when shut off.
- The digital inputs (remote switch inputs) of all SDC40 and SDC10 series units can be connected in parallel. If connecting them in parallel to another instrument, carefully check the requirements of the other instrument before proceeding.
- Do not connect SDC20/21, SDC30/31 series in parallel. Doing so may cause the external switch input to malfunction.
- Common terminals (12) and (41) of the external switch input are connected internally.

4 - 11 Communication Connection

■ RS-485 connection

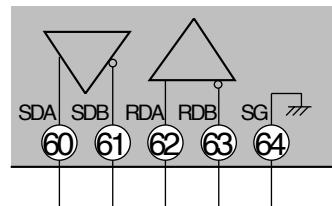

! Handling Precautions

- The slave station can be connected in a multi-drop configuration.
- Always set a unique address to each slave station.
- Attach terminating resistances (a total of four when connecting a 5-wire system) to the ends of the communications lines. Use 1/2W or greater terminating resistances of $150\Omega \pm 5\%$.
- If connecting three lines, short-circuit terminals (60), (62) and (61), (63).
- Do not short-circuit the RDA to RDB and SDA to SDB terminals. Doing so may cause the **DCP551** to malfunction.

● **5-wire system RS-485 connection diagram**

Attach 1/2W or greater terminating resistances of $150\Omega \pm 5\%$ at each end of the communications lines. Ground the shield FGs at one end in one location, not at both ends.

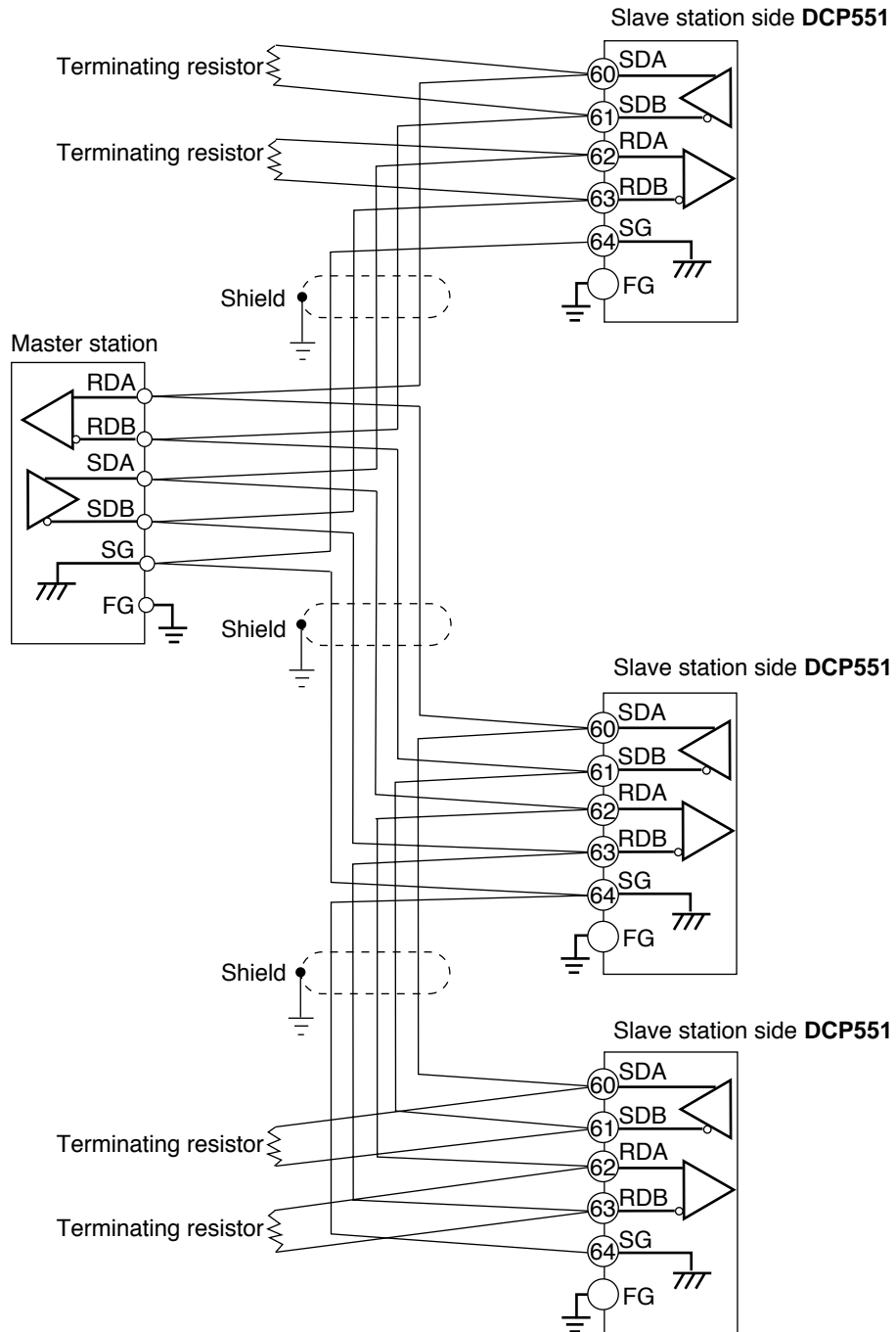

! Handling Precautions

Be sure to connect SG terminals each other.
Failure to do so might cause unstable communications.

● 3-wire system RS-485 connection diagram

! Handling Precautions

In the 3-wire system, the Yamatake CMC10L001A000 can be used as a converter in the master station.

Attach 1/2W or greater terminating resistances of $150\Omega \pm 5\%$ at each end of the communications lines. Ground the shield FGs at one end in one location, not at both ends.

When only three RS-485 terminals are provided, the areas designated with an asterisk (*) are connected internally.

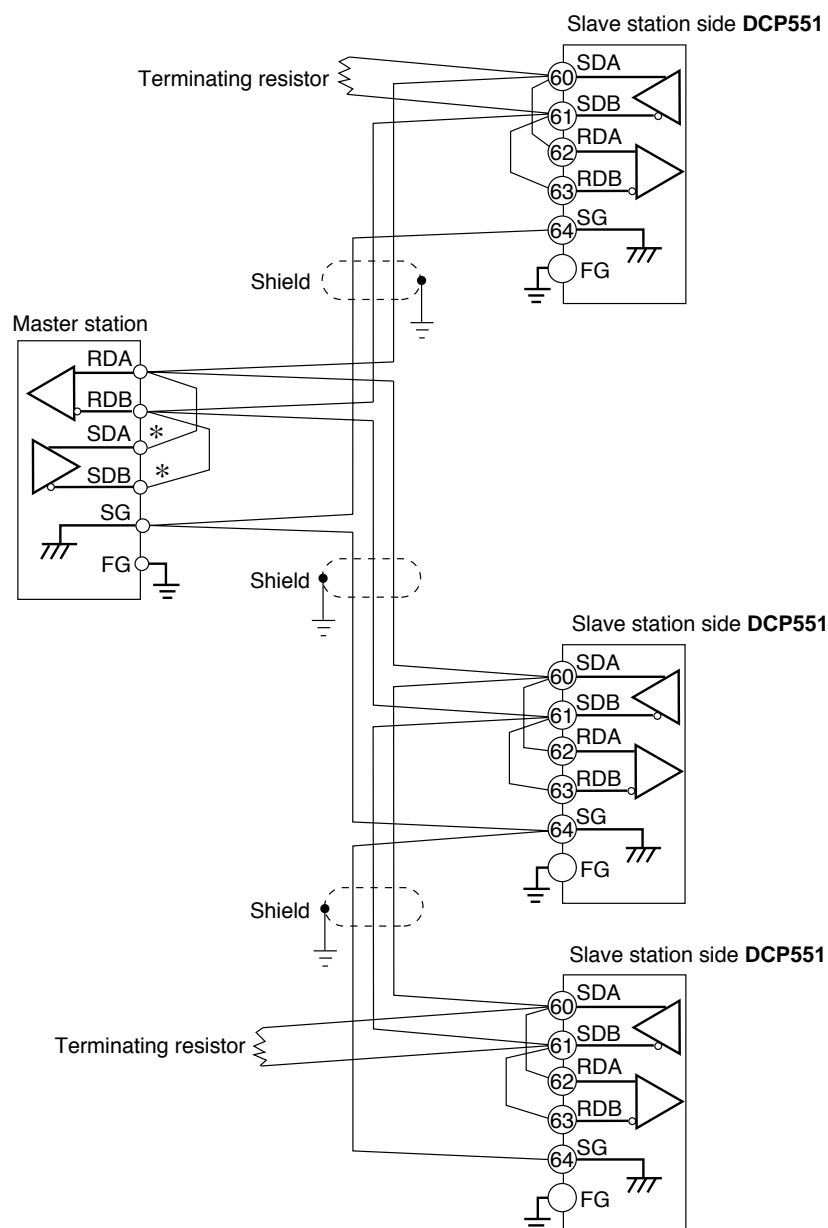

! Handling Precautions

Be sure to connect SG terminals each other.

Failure to do so might cause unstable communications.

■ RS-232C connection

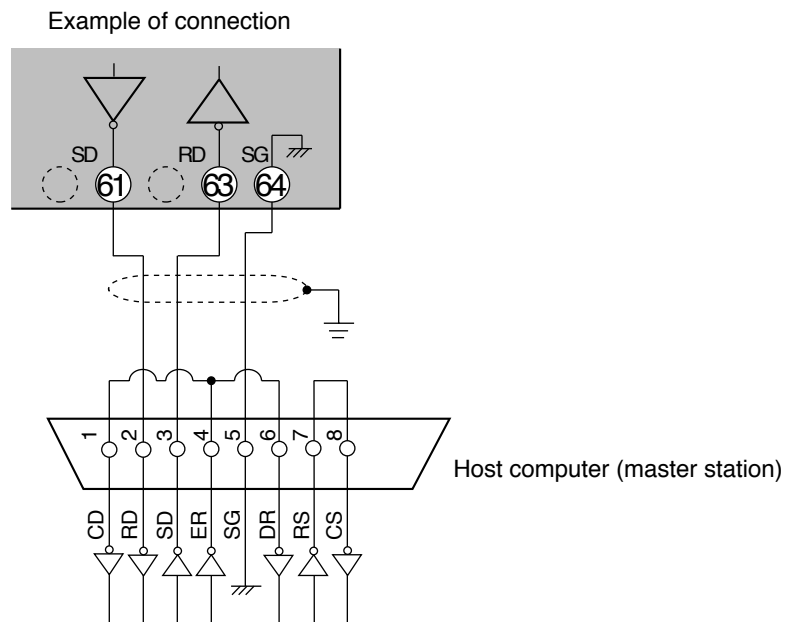

! Handling Precautions

- Connect the slave station to the master station in a single-drop (point-to-point) configuration.
- There are three (RD, SD and SG) communications terminals on the RS-232C interface on the master station which may not output data if not short-circuited as shown above.

 **NOTE**

RS-232C connector signals (9 pins)

Example : IBM and compatibles

Pin No.	JIS code	Name	Signal direction	
			Host	Instrument
1	CD	DCD	←	
2	RD	RxD	←	
3	SD	TxD		→
4	ER	DTR		→
5	SG	GND		
6	DR	DSR	←	
7	RS	RTS		→
8	CS	CTS	←	

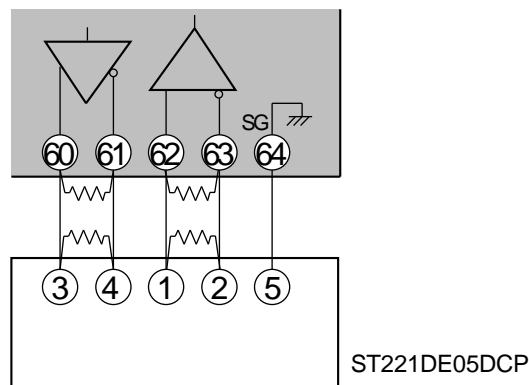
■ Connection to ST221

 **Handling Precautions**

- Attach 1/2W or greater terminating resistances of $150\Omega \pm 5\%$ at each end of the communications lines.
- The **DCP551** operates as a master station when connected to an ST221 during communications.

4 - 12 Isolation During Input/Output

Isolation between inputs and outputs are shown below. In this figure, the solid lines enclose mutually-isolated sections. Those sections bounded by dashed lines are not isolated.

PV input CH1	Digital circuit	Control output
PV input CH2		Auxiliary output CH1
Loader communication		Auxiliary output CH2
External switch input		
Communication		Event output
Memory card input*		

* : available on the DCP551A***** model only

Handling Precautions

The terminal base is not isolated from internal digital circuits.
When not in use, always replace the cap.

Chapter 5. FUNCTIONS

5 - 1 Data

■ Data types

The data types are listed below.

For further information on data types, see “Chapter 7. PARAMETER SETUP” and “Chapter 8. PROGRAM SETUP”.

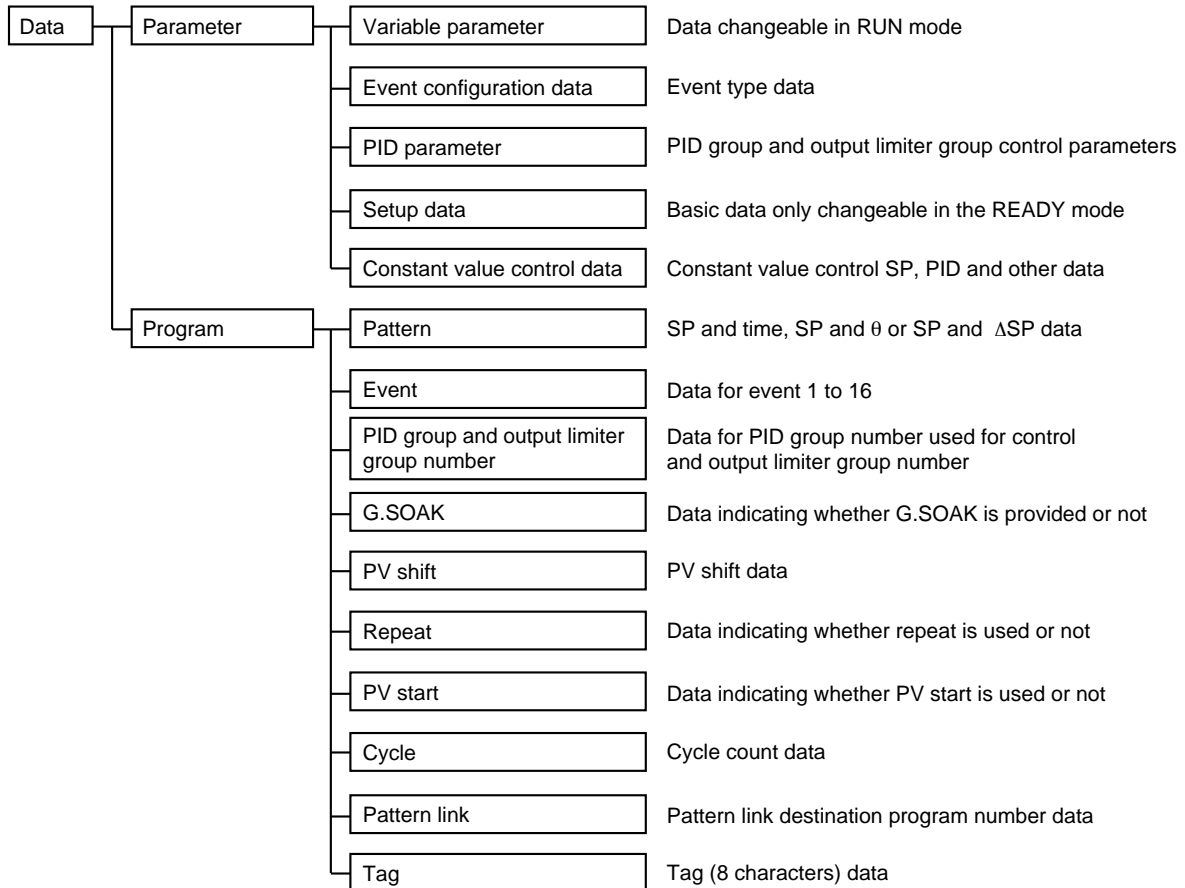

5 - 2 Program Pattern

■ Pattern

Three systems for selecting programs are provided: RAMP-X, RAMP-T and RAMP-E. The first segment of each program is always RAMP-X, but the other segments can be any system and all three types can be used in one program.

● RAMP-X system

This system, sets a segment of a pattern using SP and time, is called RAMP-X. SP setting : within the upper and lower SP limiter range

Time setting : 0 hours 00 minutes to 500 hours 00 minutes

0 minutes 00 seconds to 500 minutes 00 seconds or

0.0 seconds to 3000.0 seconds

(Time units are selected using the C62 setup data setting.)

SP is a point on the elapsed time axis in the current segment, which is a straight line connecting the start point, the SP set value in the previous segment, and the end point, the SP set value in the current segment. Segments are classified as follows.

- Rising RAMP (or rising slope)

Previous segment SP setting < current segment SP setting

- Falling RAMP (or descending slope)

Previous segment SP setting > current segment SP setting

- SOAK (soaking)

Previous segment SP setting = current segment SP setting

The start and end points of the first segment are also the SOAK segment of the SP set value for the first segment.

SP calculation (other than first segment)

$$\text{SP} = (\text{current segment SP set value} - \text{previous segment SP set value}) \\ \times (\text{current segment elapsed time} \div \text{current segment time setting}) \\ + \text{previous segment SP setting.}$$

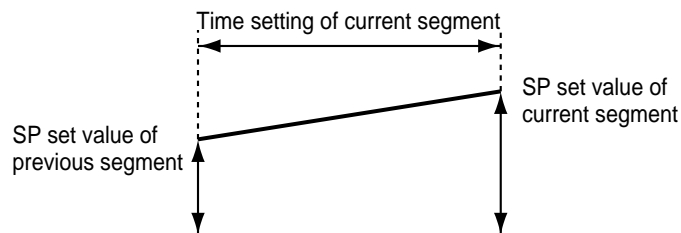

● RAMP-T system (θ setting)

In the RAMP-T system, a segment is set using SP and ramp θ (theta).

SP setting : within the upper and lower SP limiter range

θ setting : 1 to 10000 (SPU/hour, SPU/min, SPU/sec)

(Time units are selected using the C62 setup data setting.)

SP is a point on the elapsed time axis in the current segment which is an extended straight line, the ramp set value of the current segment when the SP set value in the previous segment is the start point.

The end point is the point where this line reaches the SP setpoint of the current segment. Note that the RAMP-T system cannot be used in the first segment.

SP calculation: $SP = \theta \text{ set value} \times \text{segment elapsed time} + \text{previous segment SP}$.

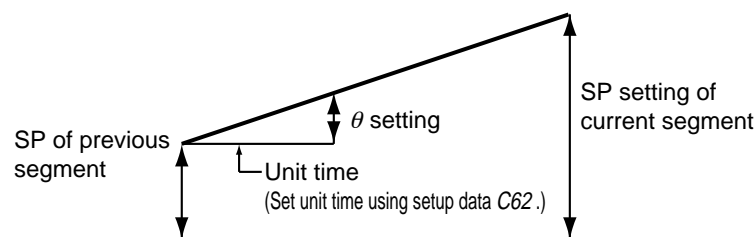

● RAMP-E system (Δ SP setting)

In the RAMP-E system, segments are set using SP and Δ SP (digital SP) for each external switch input pulse.

SP setting : within the upper and lower SP limiter range

Δ SP setting: 1 to 10000 SPU

The start point is the SP set value in the previous segment.

SP is a value resulting from adding a multiple of the external switch input count to the SP set value when the SP in the previous segment is the start point.

The segment ends when this SP reaches the SP setting in the current segment and the current segment SP is more than the previous segment SP or when current segment SP is less than the previous segment SP.

SP calculation: when current segment SP is more than the previous segment SP,

$SP = \Delta \text{ SP set value} \times \text{external switch input count} + \text{the previous segment SP}$.

When current segment SP is less than the previous segment SP,

$SP = -(\Delta \text{ SP set value} \times \text{external switch input count}) + \text{the previous segment SP}$.

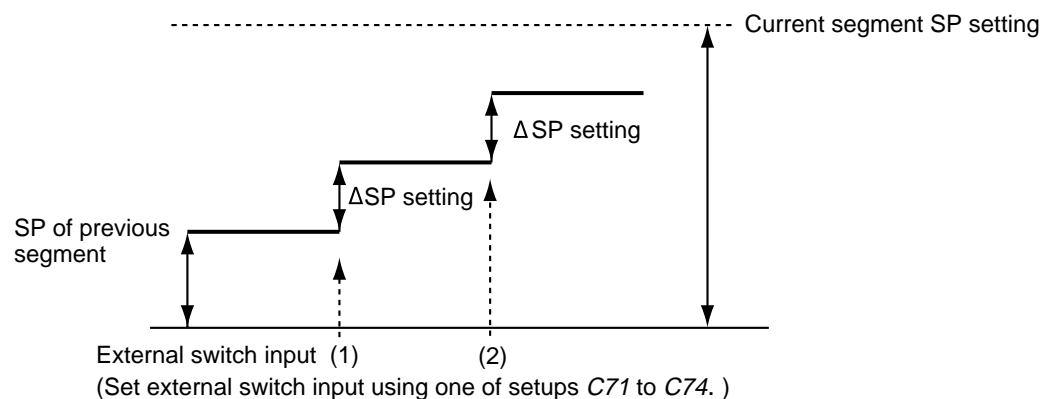

 NOTE

- Select the program pattern setting system using setup data setting *C61*.
 - 0: combined use of RAMP-X and RAMP-T
 - 1: combined use of RAMP-X and RAMP-E
- Select time setting units using setup data setting *C62*.
 - 0: hours and minutes
 - 1: minutes and seconds
 - 2: 0.1 seconds
- Select θ setting units using setup data setting *C62*.
 - 0: SPU/hour
 - 1: SPU/min
 - 2: SPU/sec
- Select SP setting and SP setting decimal position using setup data setting *C65*.
 - 0: XXXXX
 - 1: XXXX.X
 - 2: XXX.XX
 - 3: XX.XXX
 - 4: X.XXXX
- External switch for pulse input requires 1: RAMP-E using a setup data setting between *C71* to *C74*.
- The pulse input interval time can be checked by setting event type 93 in the event. Event type 93 is RAMP-E time monitored during a period of 0.0 to 3000.0 seconds.
Even when a setting is exceeded and there is no pulse input, the event remains on.

■ Events

The event configuration data setting allows event types to be set for event outputs 1 to 16.

Events are of the following four types: time event, PV event, code event and mode event. Settings are divided into two types of events: segment events and instrument event.

- Segment events are used to set the event operating point in a program setting and makes it possible to set different set values in different segments. But in the constant value control mode segment events are off.
- Instrument events are used to set events that do not require an event operating point or set the event operating point in the event configuration setting. It performs operations that are shared by all program operations and constant value control.

● Time events

The On Time or both the On and Off Time can be set by event number and segment. Output on/off duration are as shown below.

NOTE

- The On Time is indicated by the length of the line from the start of the segment until the upturned arrow.
- The Off Time is indicated by the length of the line from the start of the segment until the downturned arrow.
- When the On Time is less than the off time, the output is on from the on time until the off time.
(See segments 1, 6 and 7 in the figure.)

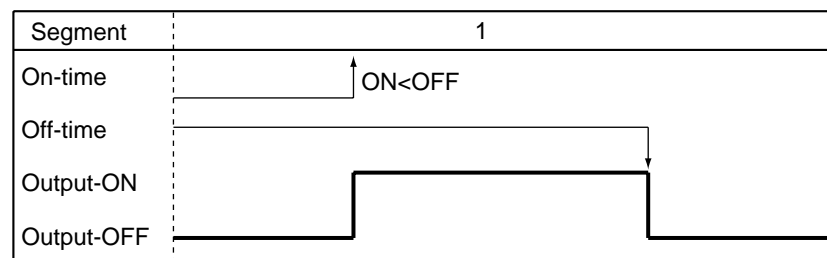

- When only an on setting is made, the output stays on until the end of the segment. (See segments 2 and 5 in the figure.)

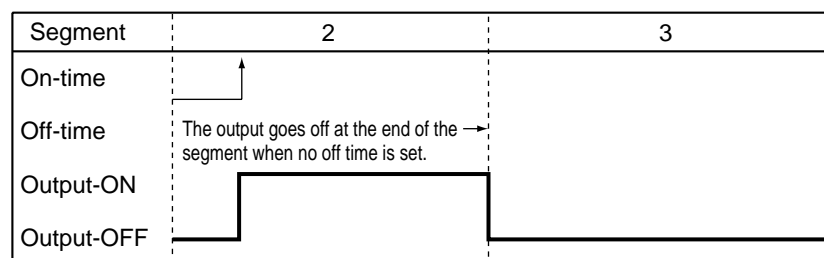

- The output is off when no On or Off Time has been set.
- An off time cannot be set without setting an on time. (See segment 3B in the figure.)

- An On Time \geq Off Time setting cannot be made. (See segment 3C in the figure.)

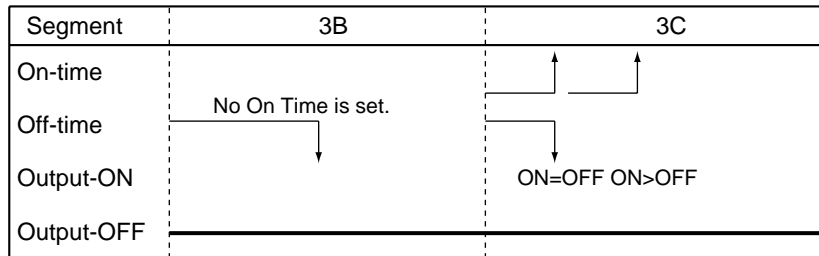

- An On Time or Off Time is valid only within a segment and cannot straddle segments. In the next segment, the On time and Off time set for that segment are valid. (See segments 4 and 5 in the figure.)

Thus an On Time and Off Time setting made at the end of a RAMP-X segment are ignored. (Compare segment 9 with the G.SOAK wait in segment 10 in the figure.)

Note, however, that an On Time or Off Time setting at the end of a RAMP-T segment is either valid or invalid depending on the computational error.

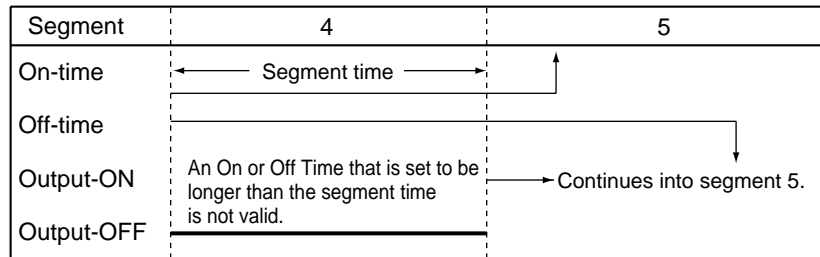

- When the On Time is set to 0 (no Off Time being set or set to more than 0), the output goes on when the On Time becomes 0. If the output was on at the end of the previous segment, it stays on and does not go off momentarily between the two segments. (See segments 5 and 6 in the figure.)

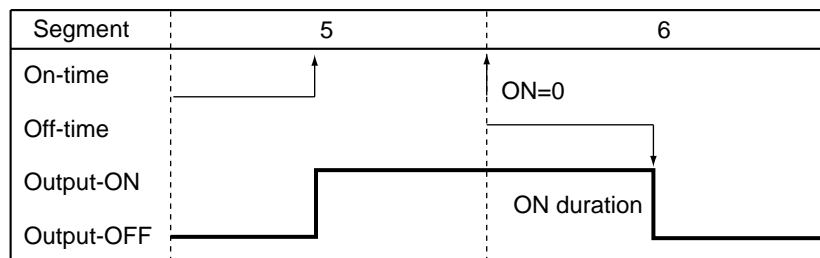

- The G.SOAK Time is not included in the On and Off Time. (See segment 7.) Nor is the Wait Time included for a G.SOAK that occupies an entire segment.

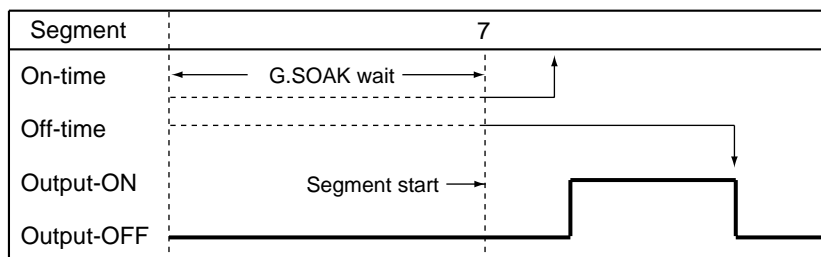

- When there is a G.SOAK wait at the start of a segment and the ON Time is set to 0, the output goes on at start of the G.SOAK wait and the On Time starts as the G.SOAK wait ends.

The output time = G.SOAK time + (Off Time – On Time) (See segment 10 in the figure.)

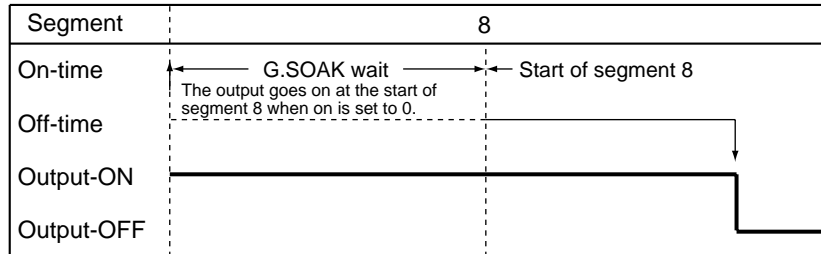

- An On Time and Off Time occurring at the end of a RAMP-X segment are valid when there is a G.SOAK wait at the end of a segment or as the end state of the final segment. (See segment 10 in the figure.)

Note, however, that an On Time or Off Time setting at the end of a RAMP-T segment is either valid or invalid depending on the computational error.

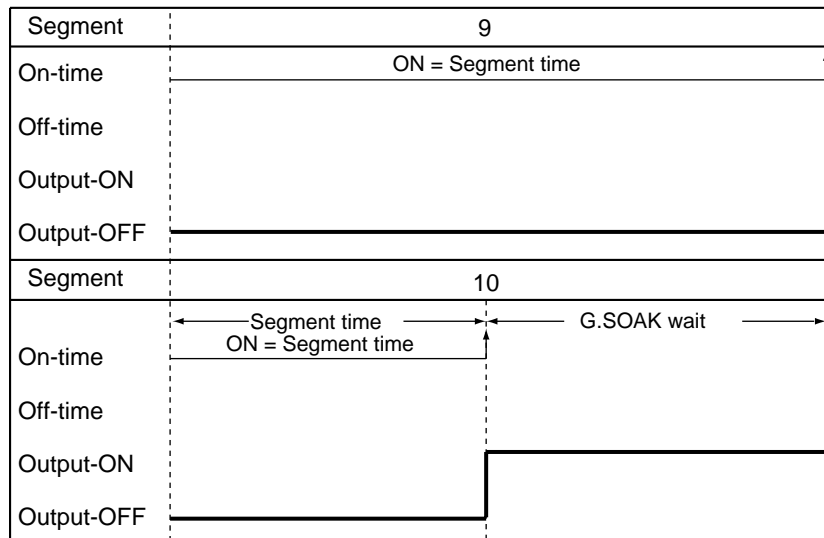

- When there is a G.SOAK at the end of the previous segment, the On Time in the next segment is ignored if it is set to 0. (See segments 11 and 12 in the figure.)
Thus the ON = 0 of segment 12 is not output at the end of the set time for segment 11, but when the G.SOAK wait ends.
- This function can be combined with an event ON delay set using PARA. Delay works when an event goes from off to on. A delay is not triggered when an On Time continues across two segments as shown in segments 5 and 6 in the figure.

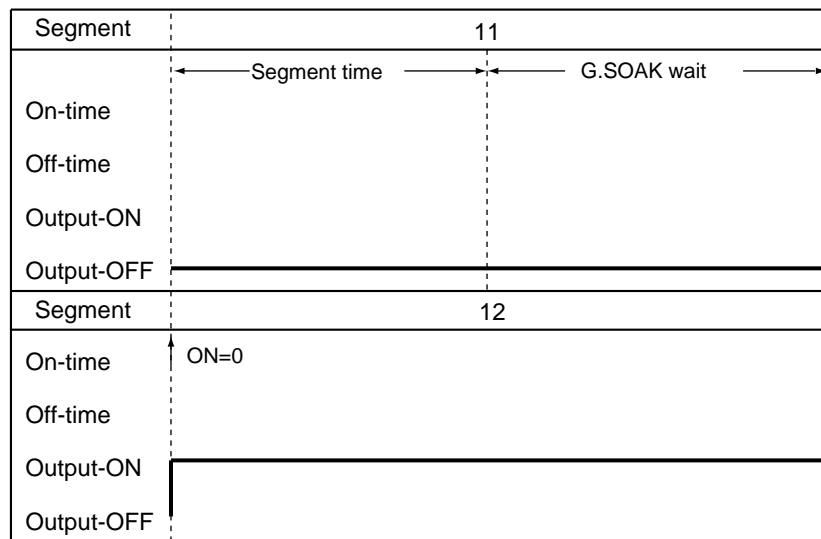

● PV event

- Basic specifications
The difference between PV, deviation, absolute value deviation, SP, MV and PV1-PV2 for each event type is shown on the following pages. The thick lines show ON and OFF conditions. The upper line indicates ON and the lower line indicates OFF conditions.
EV indicates the event set value and H indicates the hysteresis value. Outputs in READY mode are OFF. But normal PV1 upper and lower limit operation and normal PV2 upper and lower limit operation events run also in the READY mode.
- Event standby
Standby events operate as described below.
 - If the event is in the gray area shown in the figure during a change from READY to RUN mode or when the power is restored after an outage, the event operates without a standby. The upturned arrows in the figures indicate ON while the downturned arrows indicate OFF.
 - If the event is outside the gray area shown in the figure during a change from READY to RUN mode or when the power is restored after an outage, it remains off until it enters the gray area .

After entering the gray area , the upturned arrows in the figures indicate ON while the downturned arrows indicate OFF.
A standby event is off in the READY mode.

- Event on delay

The number of the event to be delayed and the delay time can be set regardless of event type. The delay turns on the output for the duration of the delay when the event meets the conditions for going from OFF to ON. When this function is combined with the event standby function, the event on delay operates when the standby state is cleared.

- Segment event progress

- The output stays OFF until the program reaches a segment with an event.
- The event goes ON or OFF according to the set value of the event.
- Previous settings are valid until segments with other event settings are reached.
- Previous settings are valid when the program has reached segment number 1 using the cycle function or pattern link function. The output is turned off if there is no event in segment number 1.

- Other functions

The MV forward/backward event does not operate when the C21 setup data setting is set to 0 during SP output (programmer function).
 Normal PV2 upper and lower limit operation events and PV1-PV2 differential of upper limit and lower limit events during automatic PV channel switching do not operate on models with only one PV input channel.
 Normal PV1 upper and lower limit operation event and normal PV2 upper and lower limit operation events operate in the READY mode.

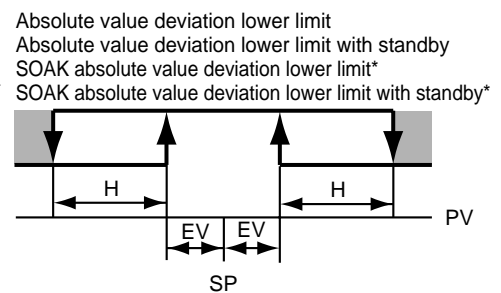
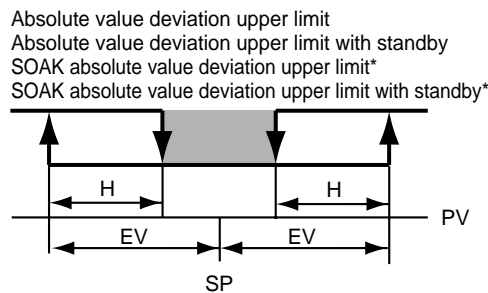
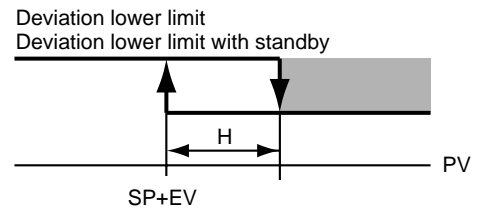
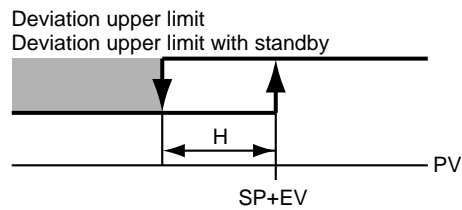
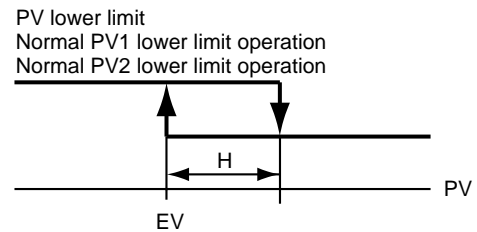
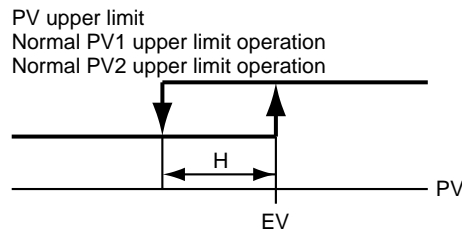

Items marked * operate only in SOAK segments.

Items marked * operate only in SOAK segments.

SP upper limit

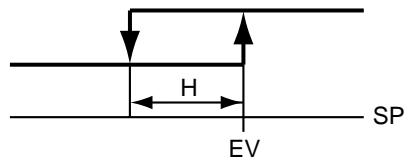

SP lower limit

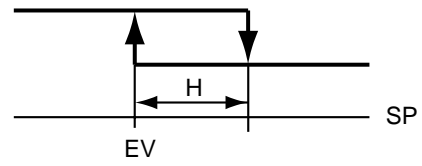

MV upper limit

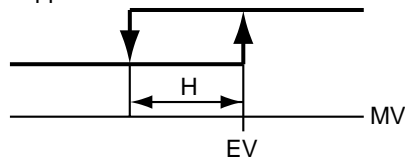

MV lower limit

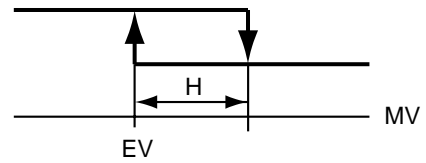

PV1-PV2 differential upper limit

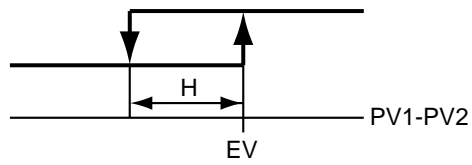

PV1-PV2 differential lower limit

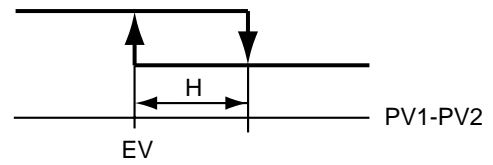

PV1-PV2 differential upper limit during automatic PV channel selection

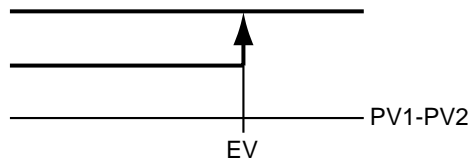

PV1-PV2 differential lower limit during automatic PV channel selection

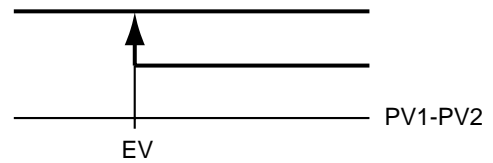

Note: When the output goes on, it stays on until READY mode.

Note: When the output goes on, it stays on until READY mode.

● PV deviation rate event

PV deviation is measured in each sampling cycle set using eventconfiguration while on/off states are determined by comparing event setting deviation rate PVs. PV deviation between sampling cycles is ignored. Event on/off switching is performed according to the sampling cycle. This function can be combined with event on delay.

Set event value is more than 0 (using upper limit event)

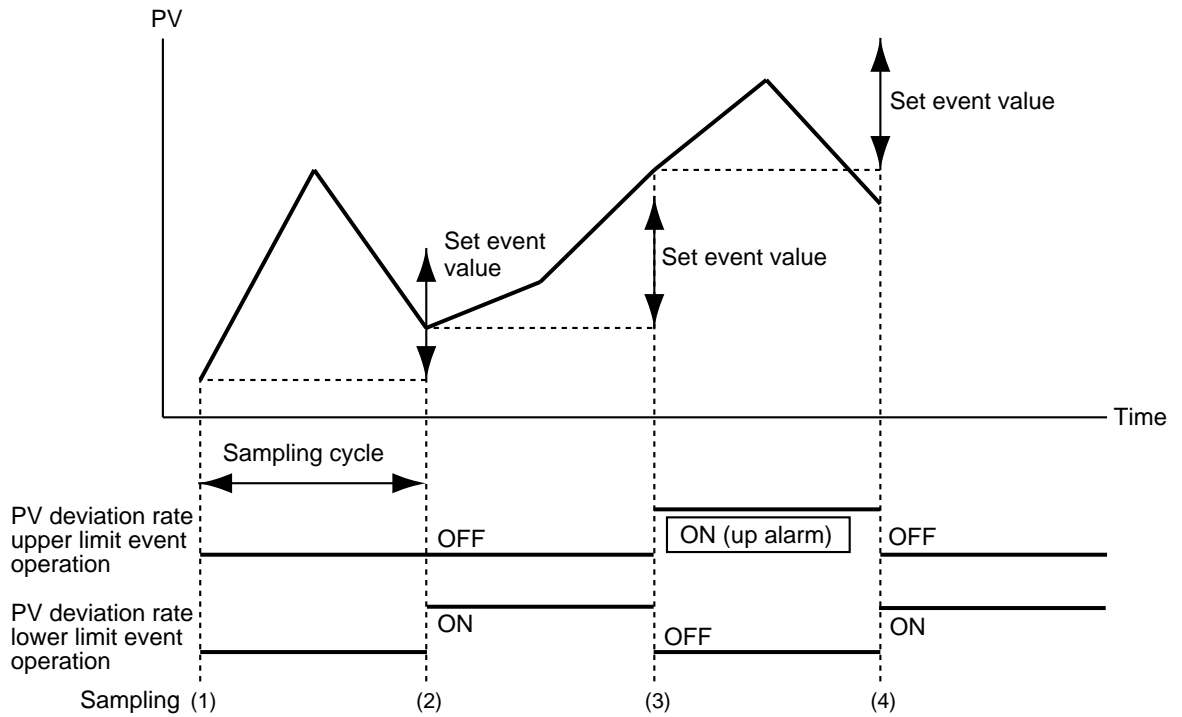

Set event value is less than 0 (using lower limit event)

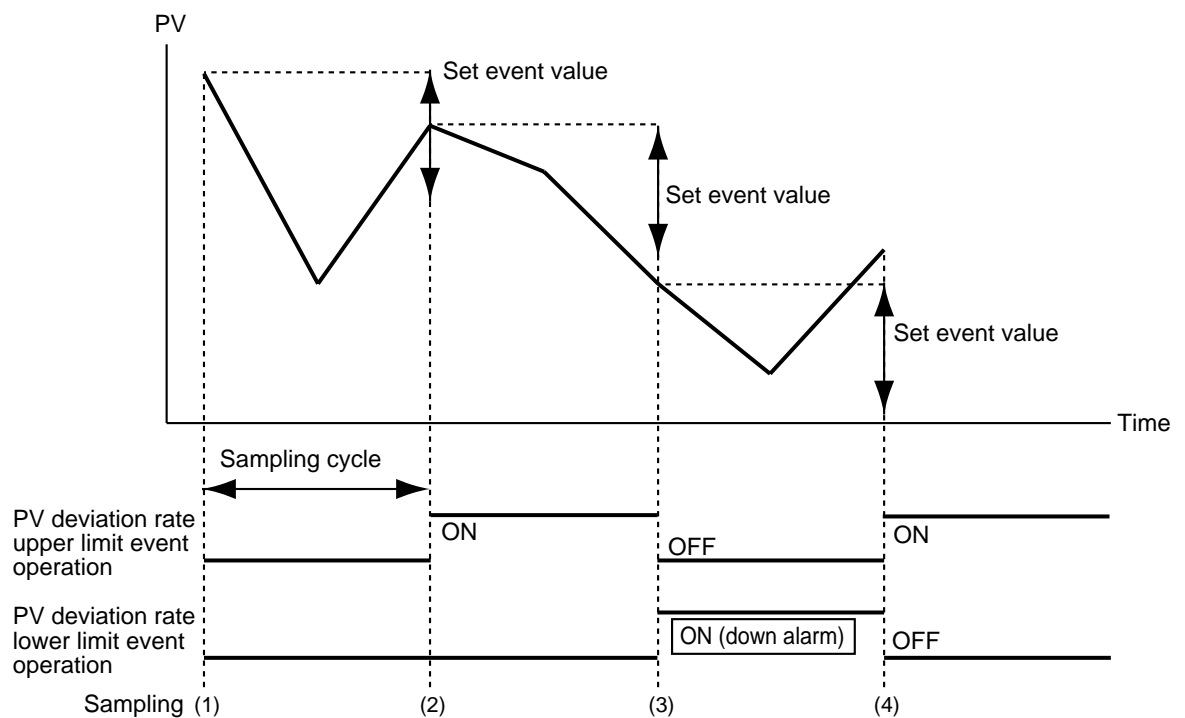

● **Code event**

Several events are used as one group and the number of output points are output as one parallel code number. Assigning code numbers to event outputs has the same effect as increasing the number of physical output points.

- Code event

Set event type to code event and set the number of output points (1 to 8) in auxiliary setting 1. An output code value (0 to 255) can be set for each segment. A binary coded low-order bit for the set number of output points is output. The previous setting is valid until the program reaches a segment with a new setting.

Note, however, that unless a setting is made in the first segment, the program will assume that a set value of 0 is set in the first segment.

Example: Setting a code event involving 3 output points in event 3

The table below shows the output state when a value of 3 is set in segment 2, a value of 6 is set in segment 4 and a value of 0 is set in segment 5.

Segment	1	2	3	4	5
Set value	Not set	3	Not set	6	0
Code value 1 in event 3	OFF	ON	ON	OFF	OFF
Code value 2 in event 4	OFF	ON	ON	ON	OFF
Code value 4 in event 5	OFF	OFF	OFF	ON	OFF
Output code	0 (OFF,OFF,OFF) (0, 0, 0)	3 (OFF,ON,ON) (0, 1, 1)	3 (OFF,ON,ON) (0, 1, 1)	6 (ON,ON,OFF) (1, 1, 0)	0 (OFF,OFF,OFF) (0, 0, 0)

- Timed code event

This function is a combination of a code event and a time event. The set code value is output at the set time. The number of settings that can be made in the first segment is the same as the number of output points. For example, for a 3-point output up to three settings can be made in the first segment.

Like a time event, a time within the time of the segment is valid and those that exceed the value are ignored. When the program reaches the start time of the first segment or a new segment, the set code value is 0 (all points off) until the set time of the time event.

Example: Setting a timed code with 3 output points in event 3

The table below shows the output state when a value of 5 is set in segment 2 and set to start at the beginning of the segment, a value of 3 is set to occur 0:10 after the start of segment 2 and a value of 4 is set to occur 0:30 after the start of segment 4.

Segment	1	2	3	4	5		
Set value	Not set	5	3	Not set	6	0	
Set time	Not set	0.00	0.10	Not set	0.30	0.00	
Time		← 0.10 →		← 0.30 →			
Code value 1 in event 3	OFF	ON	ON	OFF	OFF	OFF	
Code value 2 in event 4	OFF	OFF	ON	OFF	OFF	ON	OFF
Code value 4 in event 5	OFF	ON	OFF	OFF	OFF	ON	OFF
Output code	0 (OFF,OFF,OFF) (0, 0, 0)	5 *1	3 *2	3 (OFF,OFF,OFF) (0, 0, 0)	0 *3	6 *4	0 (OFF,OFF,OFF) (0, 0, 0)

*1: (ON,OFF,ON) *2: (OFF,ON,ON) *3: (OFF,OFF,OFF) *4: (ON,ON,OFF)
 (1, 0, 1) (0, 1, 1) (0, 0, 0) (1, 1, 0)

- Program/segment number event
 A program or a binary coded segment number is set in an event type and the number of output points (1 to 7) is set in auxiliary setting 1. Or a program or a BCD code of the segment number is set in an event type and the number of output points (1 to 8) is set in auxiliary setting 1.
 A selection, a program designed for a specific operation or a coded segment number is output. A low-order bit code corresponding to the set number of output points is output.
- An event on delay can be combined with the code event.
 Note, however, that when there are several channel code events, the delay has to be entered for each channel.

Decimal binary code comparison table

Decimal	Binary code output (0: Off output 1: On output)
1	0 0 0 0 0 0 1
2	0 0 0 0 0 1 0
3	0 0 0 0 0 1 1
4	0 0 0 0 1 0 0
5	0 0 0 0 1 0 1
6	0 0 0 0 1 1 0
7	0 0 0 0 1 1 1
8	0 0 0 1 0 0 0
9	0 0 0 1 0 0 1
10	0 0 0 1 0 1 0
11	0 0 0 1 0 1 1
12	0 0 0 1 1 0 0
13	0 0 0 1 1 0 1
14	0 0 0 1 1 1 0
15	0 0 0 1 1 1 1
16	0 0 1 0 0 0 0
17	0 0 1 0 0 0 1
	⋮

Decimal BCD code comparison table

Decimal	BCD code output (0: Off output 1: On output)
1	0 0 0 0 0 0 0 1
2	0 0 0 0 0 0 1 0
3	0 0 0 0 0 0 1 1
4	0 0 0 0 0 1 0 0
5	0 0 0 0 0 1 0 1
6	0 0 0 0 0 1 1 0
7	0 0 0 0 0 1 1 1
8	0 0 0 0 1 0 0 0
9	0 0 0 0 1 0 0 1
10	0 0 0 1 0 0 0 0
11	0 0 0 1 0 0 0 1
12	0 0 0 1 0 0 1 0
	⋮
20	0 0 1 0 0 0 0 0
30	0 0 1 1 0 0 0 0
40	0 1 0 0 0 0 0 0
50	0 1 0 1 0 0 0 0
	⋮

- **Mode event**

This event goes on or off depending on controller mode, alarm generation and other states.

It cannot be combined with the event standby function but with the on delay function. It does not set event set values (operating points) or hysteresis.

- **Basic operations**

The following types are provided.

RUN + HOLD + END + FAST

HOLD

READY + READY FAST

END

G.SOAK wait

MANUAL

During auto-turning execution

FAST + READY FAST

Console setting operation

RUN

ADV (advance)

Full alarm (logical OR)

PV range alarm

Instrument alarm

PV1 selected

PV2 selected

Battery voltage drop

The event goes on when the specified instrument state is reached and is off at other times.

- **Alarm**

Alarms are of two types: PV range alarm group (alarm code number 01 to 04) and instrument alarm group (alarm code number 91 to 99 and battery voltage drop). When the event type is all alarm, the event goes on if one alarm occurs.

When the event type is a PV range alarm, the event goes on if one alarm in the PV range alarm group goes on.

When the event type is an instrument alarm, the event goes on if one alarm in the instrument alarm group goes on.

- **ADV**

When ADV (advance) is executed, the event goes on for 1 second. This function is valid during on delay.

■ PID group selection

- ID groups can be selected in two ways: by setting a PID segment or through automatic PID group switching.

A PID group segment and automatic PID group switching can also be combined. When a PID group number is set to 0, the setting in the previous segment is continued.

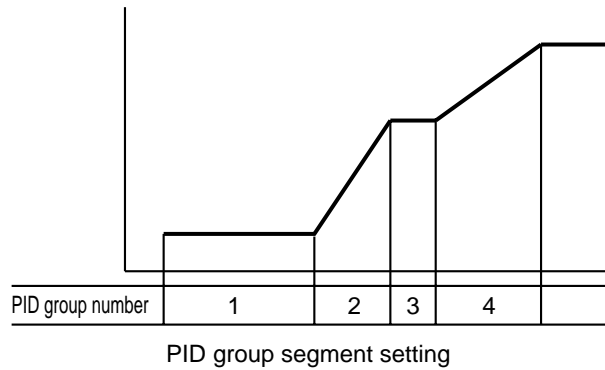

- In a PID group segment setting a PID group number is set in each segment and PID parameters are used for calculating the control output. The nine PID groups *PID1* to *PID9* can be used.
- In automatic PID group switching, the entire SP scale is divided into seven zones assigning *CP-A1* to *CP-A6* to each. The PID constants that are used according to SP values are automatically selected to calculate control output. The PID group number for each segment specifies A. Seven PID groups from *PID-A1* to *PID-A7* can be used.

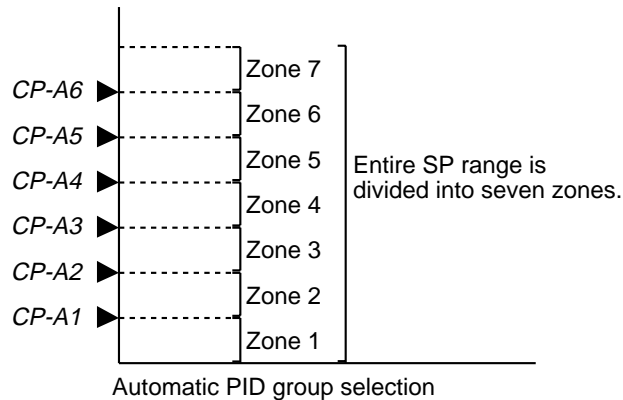

■ Selection of output limiter group

- Output limiter group number can be set for each segment to control the lower limit (OL) and upper limit (OH) of the control output. *OL* and *OH* groups 1 to 9 can be used.
- The output limiter can only be specified by segment; automatic selection cannot be made.
- When the output limiter is set to 0, the setting in the previous segment is continued.

■ G.SOAK (Guarantee soak)

G.SOAK on/off state, type and G.SOAK width is set by the segment. G.SOAK are of three types: segment start point, segment end point and the entire segment.

G.SOAK time is set using the variable parameter *PA46* setting. Any offset between SP and PV triggers a G.SOAK wait which narrows the distance between SP and PV to guarantee the segment execution time. G.SOAK operates not only on SOAK but also on RAMP segments.

Note, however, that in FAST mode a G.SOAK setting does not trigger a G.SOAK wait.

G.SOAK can be cleared with an external switch input. The following types of clearing conditions can be selected using setup data setting *C71* to *C74*.

- (1) G.SOAK is cleared when an external switch contact is set to on or when PV meets the G.SOAK clearing conditions.
- (2) G.SOAK is cleared when an external switch contact is set to on and PV meets the G.SOAK clearing conditions.

- G.SOAK at start of segment

PV and SP are compared at the beginning of the segment. The segment starts when the absolute value of the difference continues beyond the G.SOAK time and becomes narrower than G.SOAK width.

A G.SOAK wait state continues until these conditions are met which is announced by the flashing of the linear LED on the left of the profile display.

The operating condition is the same as HOLD at the beginning of a segment (time = 0).

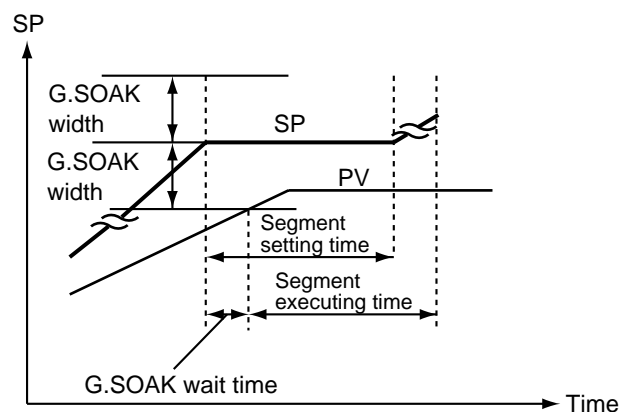

- G.SOAK at end of segment

PV and SP are compared at the end of the segment. The operation in that segment ends when the absolute value continues beyond the G.SOAK time and becomes narrower than G.SOAK width.

A G.SOAK wait state continues until these conditions are met which is announced by the flashing of the linear LED at the center of the profile display. The operating condition is the same as HOLD at the end of a segment (time = set segment time).

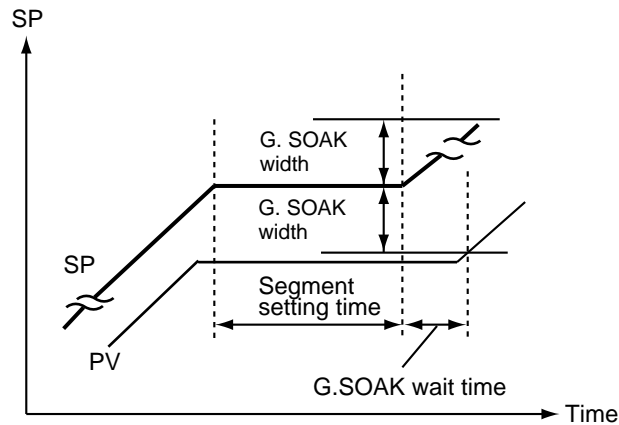

- G.SOAK for entire segment

PV and SP are compared at across the entire segment. The operation in that segment continues when the absolute value continues beyond the G.SOAK time and becomes narrower than G.SOAK width.

A G.SOAK wait state continues until these conditions are met which is announced by the flashing of the linear LED at the left and the center of the profile display.

The operating condition is the same as HOLD at the continued time.

■ PV shift

A PV correction value can be set for each segment. PV is PV input value plus PV bias and PV shift. Note, however, that in the READY mode and the constant value control mode, PV bias but not PV shift is added to the PV input value.

The setting in the previous segment continues when PV shift is set to “-----” (nothing).

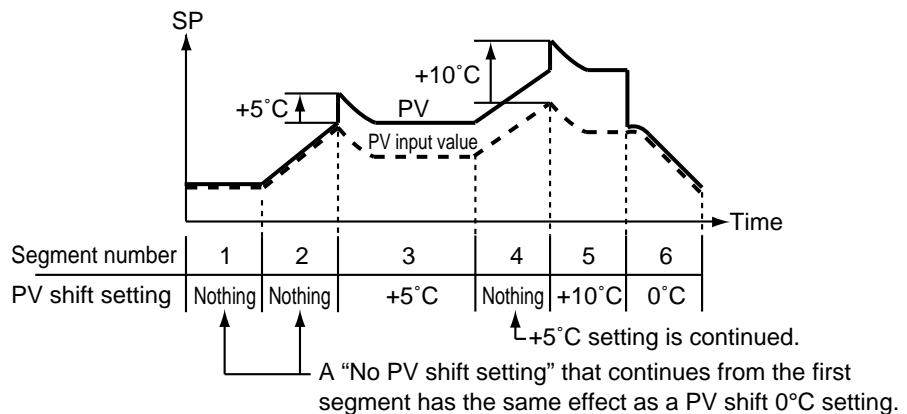

Repeat

Repeat on/off and return destination are set by the segment with the segment number and repeat count. Operation completes at the end of a segment. If there is a repeat setting, the program returns to the start of the set destination segment and operation is resumed from there. This operation is repeated the number of times specified by the repeat count.

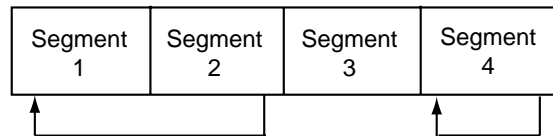

No repeat is performed when the destination segment number is larger than the current segment number. When the program returns to the first segment, PV is not started even if a PV start setting has been made.

! Handling Precautions

- When repeat operations involve multiple segments and the destination segment settings overlap, nest or intersect, the repeat operation will become an abnormal eternal loop. Do not make such settings.

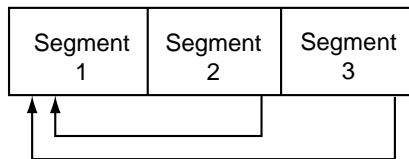

Example of a double

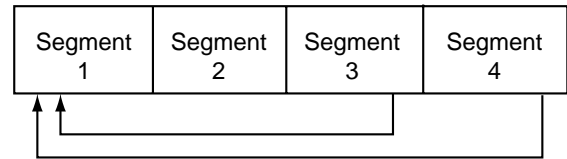

Example of a nest

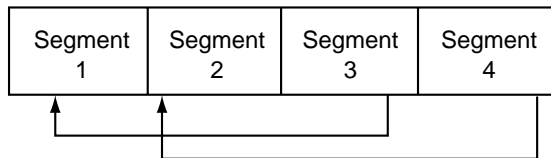

Intersect example (1)

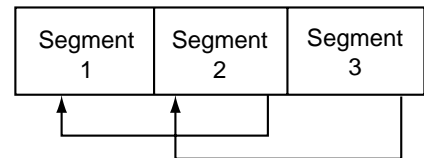

Intersect example (2)

- When the current segment does not contain a set value or the value is 0, executed values for program items (for example, set PV event values or set PID group selection values) that are sequels to settings in a previous segment are the same during the first run and the repeat run.

■ PV start

When a PV start is set in the program setting, a PV start is performed in a normal RUN operation.

The program looks for the first point where PV and the program pattern SP are equal (both PV and SP include bias) and starts operation from there. PV starts are of three kinds: rising PV start that looks for a point where PV and SP are equal on a rising RAMP, falling PV start that looks for a point where PV and SP are equal on a falling RAMP and bi-directional PV start that looks for such a point both on rising and falling RAMPs.

Note, however, that if there is no point where PV and SP are equal, operation starts from the beginning of segment 1.

When a PV start has been implemented, the event operating point and the time event time are automatically corrected. This is described in the figure shown below. When PV is at (1) in the figure, a rising PV start or a bi-directional PV start starts from B and a falling PV start starts from C. When PV is at (2) in the figure, a falling PV start or a bi-directional PV start starts from D and a rising PV start starts from A. When PV is at (3) in the figure, any PV start starts from A.

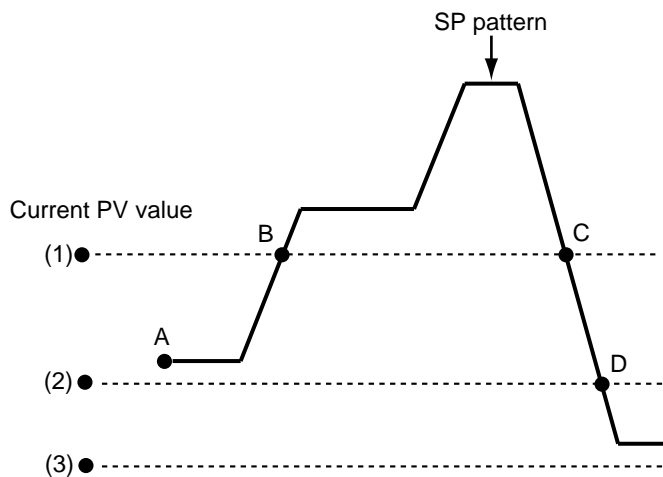

 NOTE

PV start is valid for segments in the selected program but not for segments beyond a pattern link destination.

■ Cycle

The cycle function allows you to repeat operation from segment 1 to the last segment in a program pattern the number of times set in the cycle count. A total of 10,000 times can be set.

When a cycle number of n is set, the total operation count is $n + 1$. During cycle operation, the operation at the last point in the final segment is not performed and executed values of program items (sequels to settings in the previous segment ; for example, PV event value, pid group number) that continue from a previous segment are cleared before program restart.

When the SP start point and end point are not equal, SP changes in a step-like manner during cycle operation.

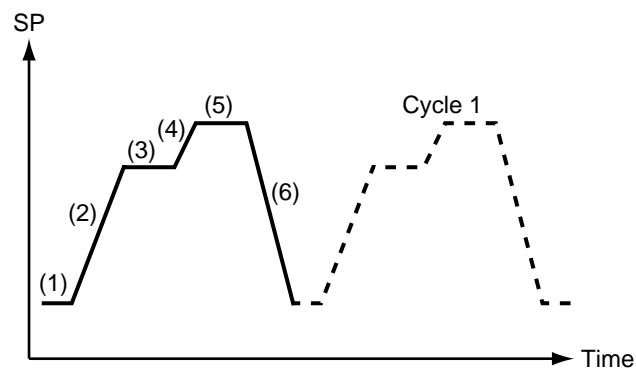

■ Pattern link

The pattern link function links patterns; the program number of the link at the destination is set in the pattern link item. An initial value of 0 indicates that linking is not performed.

When the number of the program is set in the pattern link item, it forms an eternal loop.

When SP at the end of the original link and SP at the destination are not equal, SP changes in step-like manner.

When cycle operation has been set, the pattern link operates after the cycle operation has been completed.

Since operation starts from the first segment at the destination during pattern linking, executed values of program items (sequels to settings in the previous segment) that continue from a previous segment are cleared before program restart.

When a PV start has been programmed in a pattern at the destination link, the PV start function operates after the link has been made.

PID computations are not initialized but continued after a link has been established.

When the READY mode is invoked at the end of an operation or in a RESET operation, operation returns to program number 1 that is switched from READY to RUN mode (RUN to READY). If a RESET is performed when a program at the pattern link destination is reached during an ADV operation in the READY mode, operation returns to segment 1 of the link destination program number. Note, however, that program numbers selected using the external switch takes priority.

Linking program No. 1 and program No. 2

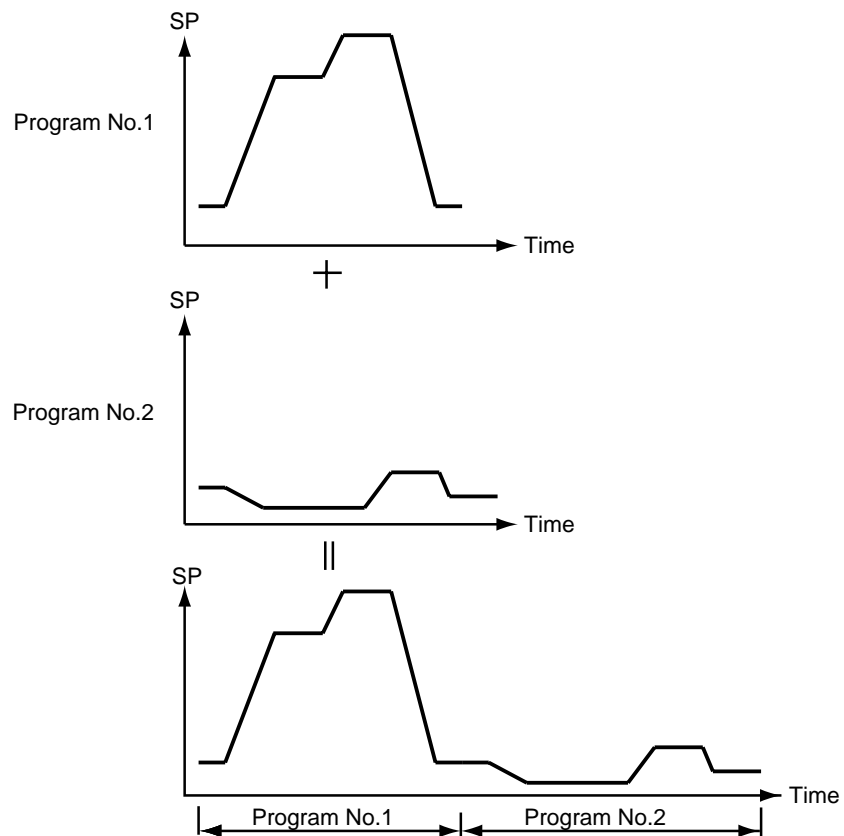

■ Tag

Tags are 8-character alphanumerics, katakana or symbols that can be entered in a program.

When segment 1 pattern item is set in a program setting, a total of eight characters consisting of PROG plus two characters in the program number and “_” two space characters.

Example: Program no. 1 : “*PROG01_*”

Program no. 19 : “*PROG19_*”

5 - 3 Mode

■ Mode types

Modes are listed below.

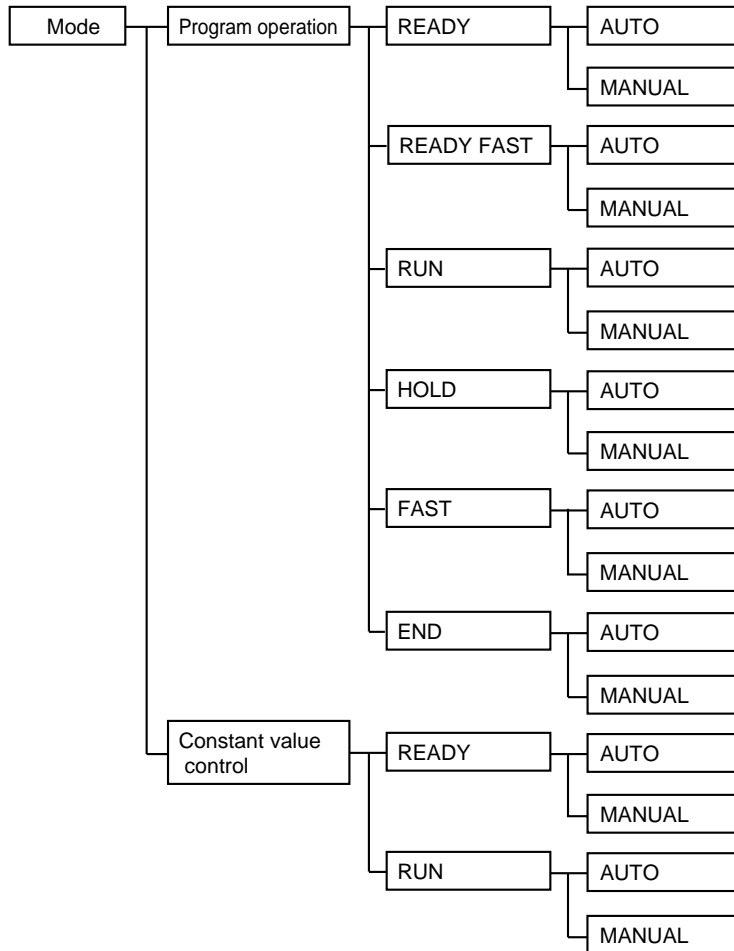

- **Program operation**

The program is run according to SP, time, events and other settings made in program patterns 1-99.

- **Constant value control**

The control is run according to SP and events made with the constant value control data.

- **READY**

READY indicates that the program is ready to run.

MV becomes fixed and events whose operation depends on values set in the segments are turned off. Note, however, that **DCP551** state dependent events still run.

Program numbers between 1 to 99 and set segment numbers can be selected during program operation.

All setup data, some event configuration data and some constant value control data parameters can be changed in the READY mode.

Memory cards can also be used in the READY mode.

- **RUN**

The RUN mode indicates that the program is run sequentially. MV output and events operate during PID control, ON-OFF control and other types of control. In the program RUN mode, program operation progresses according as time elapses. Note, however, that G.SOAK (guarantee soak) wait, like the HOLD mode, halts program operation.

- **HOLD**

The HOLD mode temporarily halts program operation. Note, however, that, like the RUN mode, MV output and events operate during PID operation, ON-OFF control and other types of control. During constant value control the HOLD mode cannot be invoked.

- **FAST**

The FAST mode is essentially a speeded-up version of the RUN mode. The time factor is selected using variable parameter *PA39*. MV output and events operate during PID control, ON-OFF control and other types of control. G.SOAK (guarantee soak) settings are ignored. During constant value control the FAST mode cannot be invoked.

- **END**

The END mode indicates the state of a program that has run its course. When a program stops at the end, MV output and events operate during PID control, ON-OFF control and other types of control. During constant value control the END mode cannot be invoked.

- **READY FAST**

The READY FAST mode is a combination of the READY and FAST modes. MV output, SP output and events operate in the same way as in the READY mode. Program numbers and segment numbers cannot be selected. Parameters that can only be changed in the READY mode and memory card operation cannot be performed in this mode. During constant value control the READY FAST mode cannot be invoked.

- **AUTO**

The AUTO mode performs automatic operation. MV outputs can be used depending on **DCP551** control. (Note, however, that when programmer functions are selected, **DCP551** dependent SP outputs operate.)

- **MANUAL**

The MANUAL mode performs manual operation. The “↑”, “↓”, “←” and “→” console keys can be used to change communications and MV output. (Note, however, that when setter functions are selected, communications and SP output can be changed.)

■ Mode transitions

● Program operation

Mode transitions are indicated by the solid line arrows and end operation is indicated by the dashed lines in the figure below.

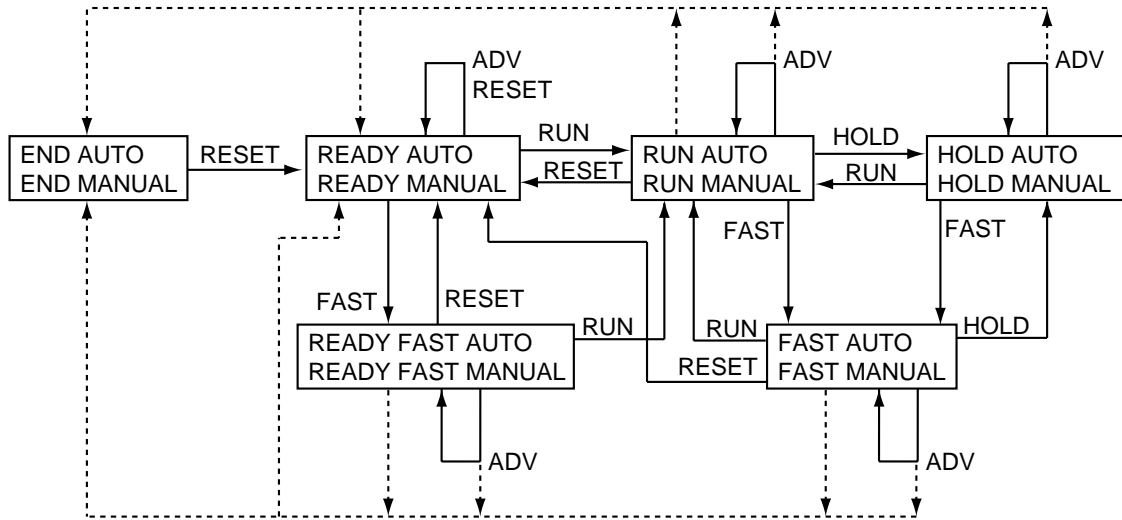

NOTE

- AUTO ⇔ MANUAL mode changes can be made in the boxes of each mode.
- READY and END at the end of operation can be selected using setup data C31.

● Constant value control

Mode transitions are indicated by the solid line arrows.

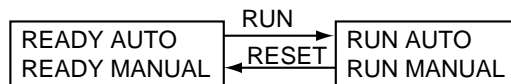

NOTE

AUTO ⇔ MANUAL mode changes can be made in the boxes of each mode.

● Switching between program operation and constant value control

Constant value control data “ConSt” control mode item in the READY mode is used to switch between these two modes.

- 0: Program operation
- 1: Constant value control

NOTE

Constant value control is available only when setup data setting C21 is set to more than 0. When C21 is set to 0, ConSt is also set to 0.

■ Mode transition operations

Mode transitions are performed using the following operations.

Although “Operation end” is not an operation, it is described here as a factor in mode transitions.

● RUN

Switches from the READY, HOLD, FAST and READY FAST modes to the RUN mode. To go from the READY mode or READY FAST to the RUN mode using keys, external switches or transmission, the **DCP551** must be in basic display status.

● HOLD

Switches from the RUN and FAST modes to the HOLD mode. During constant value control the HOLD mode cannot be invoked.

● RESET

Switches from the RUN, HOLD, FAST, END and READY FAST modes to the READY mode.

In program operation, the reset involves returning the program to the first segment.

● ADV

Brings the program forward by one segment in the READY, RUN, HOLD, FAST and READY FAST modes. ADV (advance) operation is not available in the constant value control mode.

● FAST

The FAST mode is invoked from the RUN, HOLD, READY and READY FAST modes. During constant value control the FAST mode cannot be invoked.

● AUTO

Switches from the MANUAL mode to AUTO mode.

● MANUAL

Switches from the AUTO mode to MANUAL mode. The basic display status changes as follows during this transition.

- A controller function displays PV and output value (%).
- The programmer function displays PV and SP.

Switching from AUTO to MANUAL using external switches or transmission invokes the basic display status even when the parameter setting status or programmer setting status are in use.

● Operation end

Operation ends when all progress of program settings including cycle and pattern links reach the end in the RUN, FAST and READY FAST program operation modes or during an ADV operation. By making a setup selection, it is possible to set READY or END as the state of the controller when the program reaches its end.

Note, however, that when an operation ends in the READY FAST mode, it always ends in the READY mode. In constant value control mode, operation end is not available.

■ Mode transition restrictions

Modes can be changed using console keys, external switch inputs or through communications. The table below shows the operations that are valid for each mode.

Operation		RUN (To RUN mode)			HOLD (To RUN mode)			RESET (To READY mode)			ADV (To next segment)			FAST (To FAST or READY FAST mode)		
		Key	Switch	Commu- nication	Key	Switch	Commu- nication	Key	Switch	Commu- nication	Key	Switch	Commu- nication*	Key	Switch	Commu- nication
Program operation	READY	*	*	*	-	-	-	-	Δ	*	-	*	-	*	*	*
	RUN	-	-	*	*	○	*	*	○	*	*	○	*	*	○	*
	HOLD	*	○	*	-	-	*	*	○	*	*	○	*	*	○	*
	FAST	*	○	*	-	○	*	*	○	*	*	○	*	-	-	*
	END	-	-	-	-	-	-	*	○	*	-	-	-	-	-	-
	READY FAST	*	*	*	-	-	-	*	○	*	*	○	*	-	-	*
Constant value control	READY	*	*	*	-	-	-	-	-	*	-	-	-	-	-	-
	RUN	-	-	*	-	-	-	*	○	*	-	-	-	-	-	-

Operation		MANUAL (To MANUAL mode)			AUTO (To AUTO mode)		
		Key	Switch	Communication	Key	Switch	Communication
Program operation	AUTO	*	○	*	-	-	*
	MANUAL	-	-	*	*	○	*
Constant value control	AUTO	*	○	*	-	-	*
	MANUAL	-	-	*	*	○	*

○ : Valid operation

* : Operation from basic display status valid

Δ : Returns to the first segment remaining in the READY mode.

* : Operation is invalid, but the communication end code is normal if performed in the basic display status.

- : Invalid operation

* ADV operation performed via communications may not go to the next segment but to the segment set in the communications message.

5 - 4 Controllers and Programmers

Setup data C21 allows the user to select the controller function or the programmer function.

● Controller

PID controller computations can be performed using PV, SP and PID set values and the result of the manipulated variable is output via an analog output.

ON-OFF control can be used instead of PID control.

In the MANUAL mode, manipulated variable levels can be controlled by keys available in the basic display status.

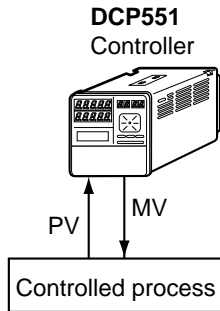

● Programmer

PID control computations are not performed and 4 to 20mA output of scaled SP signals are output.

In the MANUAL mode, SP levels can be controlled by keys available in the basic display status.

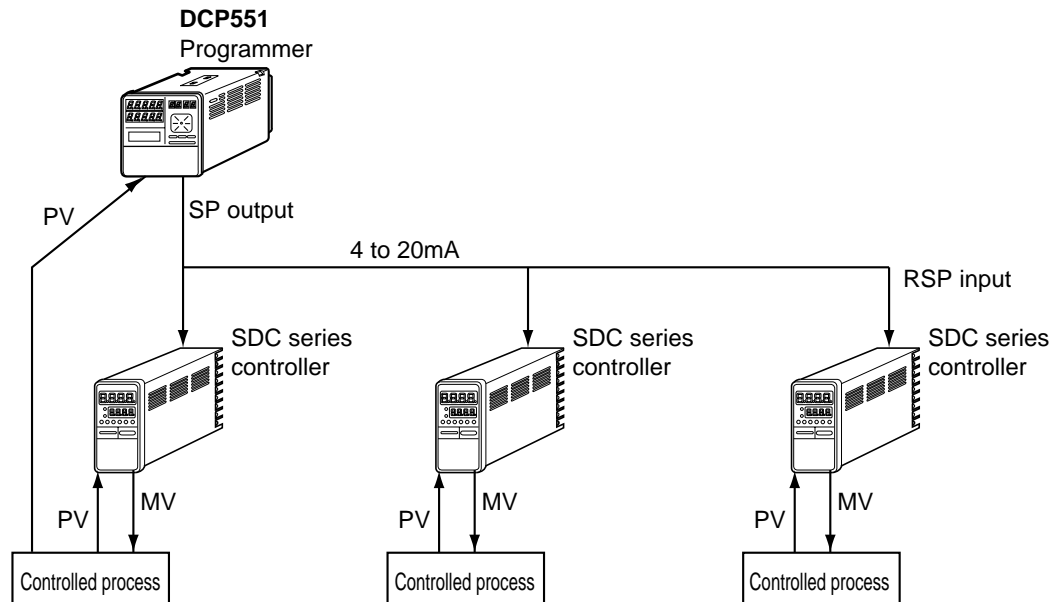

NOTE

The constant value control mode cannot be invoked when the programmer function is used.

5 - 5 Input Process Functions

This section uses diagrams to describe input processes.

■ PV input 1 channel model

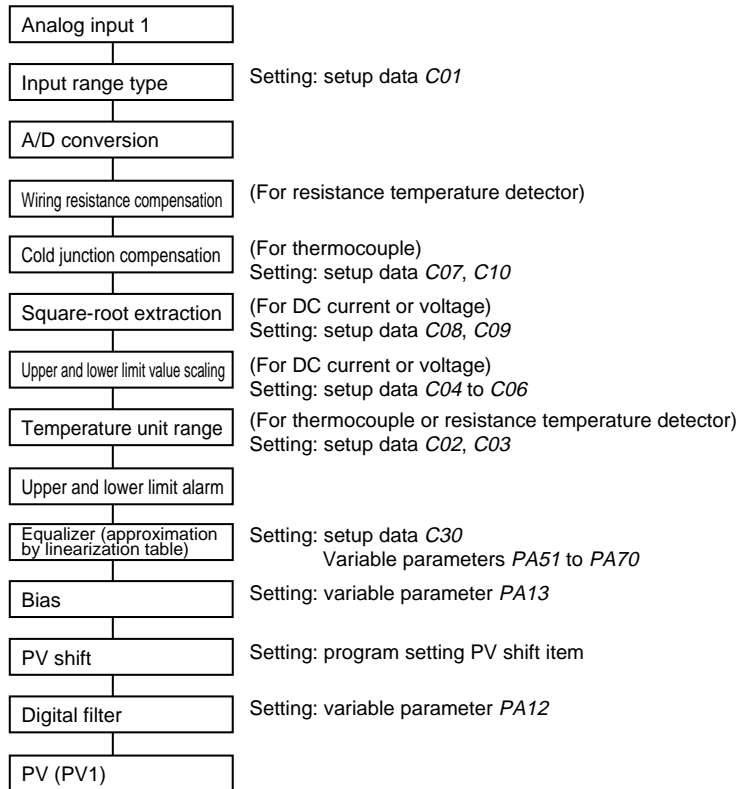

NOTE

The use of equalizer (approximation by linearization table) is shown in the figure below.

When a sensor with curved characteristics is used to measure PV, a linearization table is used.

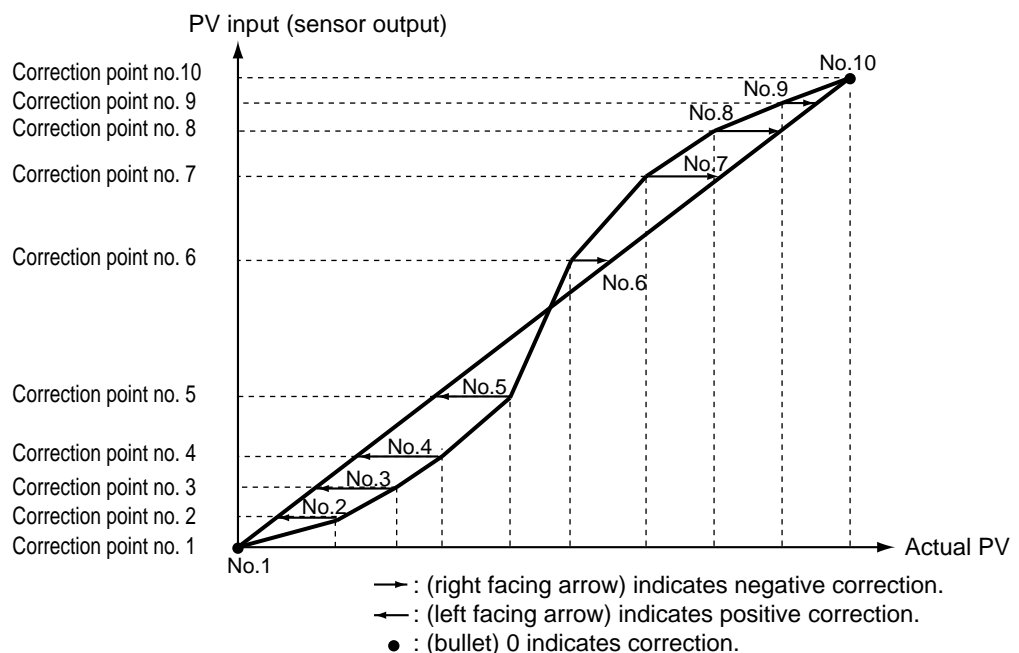

■ PV input 2 channel model

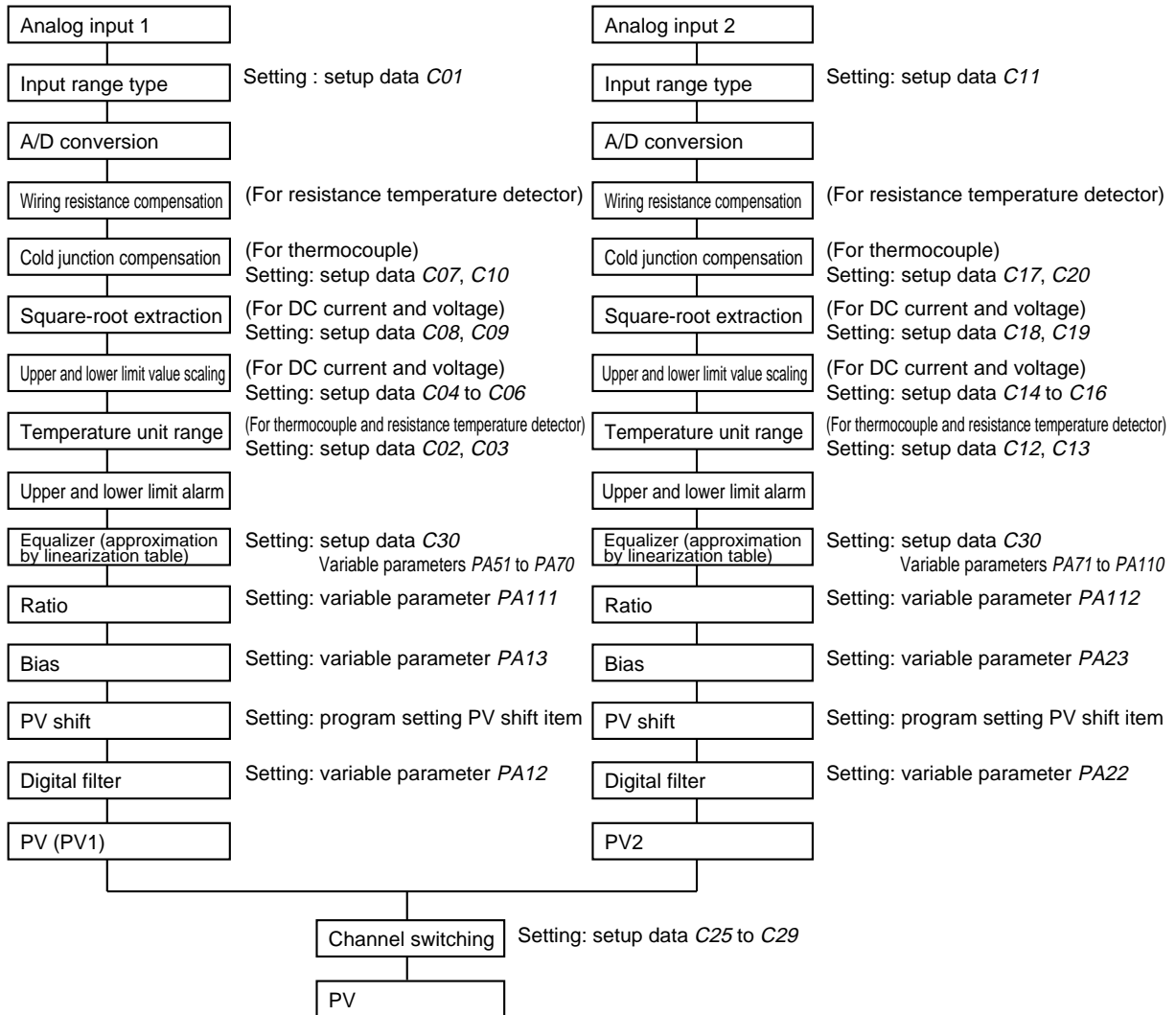

■ Channel switching (PV input 2 channel model)

● Switching types

The following switching types are provided.

- Selecting high and low-temperature sensors for PV CH1 (CH1 below) and PV CH2 (CH2 below)

(1) CH1 is a low-temperature sensor + CH2 is a high-temperature sensor

(2) CH1 is a high-temperature sensor + CH2 is a low-temperature sensor

- CH tied for control use

PV tied for operation and control

(1) Tied CH1 PV

(2) Tied CH2 PV

- Backup switching

Two temperature sensors are used. Thus if one sensor should breakdown, the program can switch to the other and continue normal operation. The main channel (CH1) is used for operation and control. In the event of an overrange (up or downscale), the subchannel (CH2) is used for operation and control to ensure normal operation. When both the main and subchannels are in overrange, the main channel is used.

The manipulated variable setting during this overrange is valid. The normal channel is CH1 and the subchannel is CH2. Note, however, that when 7 is set in one of setup data *C71* to *C74*, this situation is reversed when an external switch is turned on.



NOTE

Switching type

Setup data setting *C25*

0: Low-temperature CH1, high-temperature CH2

1: Low-temperature CH2, high-temperature CH1

2: CH1 setting

3: CH2 setting

4: Backup switching

● Low-temperature, high-temperature switching systems

The following switching system is used when CH1 is a low-temperature sensor and CH2 is a high-temperature sensor or CH1 is a high-temperature sensor and CH2 is a low-temperature sensor.

- Switching using the external switches

To switch using the external switches, set 0 in setup data *C26* and 7 in one of settings *C71* to *C74*.

Switch to CH1 when the external switches are off and switch to CH2 when they are on. When the external switches are off, the CPL communications command (WS or WB) can be used to switch between CH1 and CH2.

- Automatic changeover A

Set 1 in setup data setting C26 to allow automatic changeover to set the temperature (switch point) where channels are switched and the dead band setting that prevents switch chattering. Examples 1 to 4 below describes switch operations.

Example 1:

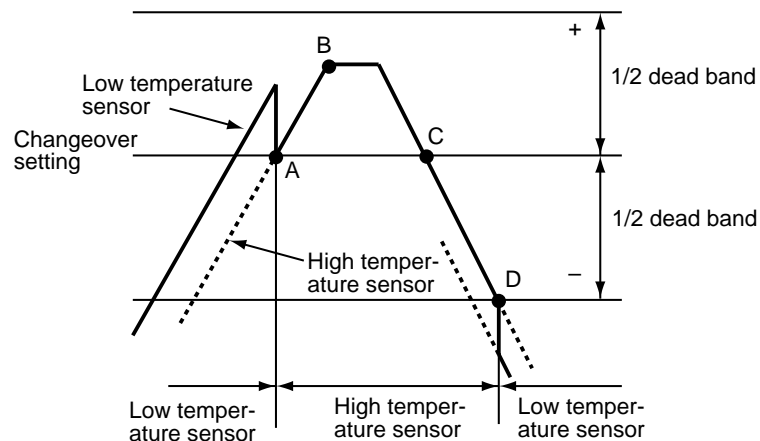

- (1) When the high-temperature sensor senses that the temperature has risen to changeover point A, the channel switches from the low-temperature to the high-temperature sensor.
- (2) No switching is performed at changeover point C when the high-temperature sensor senses that the temperature has only reached point B and does not exceed the upper limit of the dead band.
- (3) When the high-temperature sensor senses that the temperature has dropped to point D the lower limit of the dead band, the channel switches from the high-temperature to the low-temperature sensor.

Example 2:

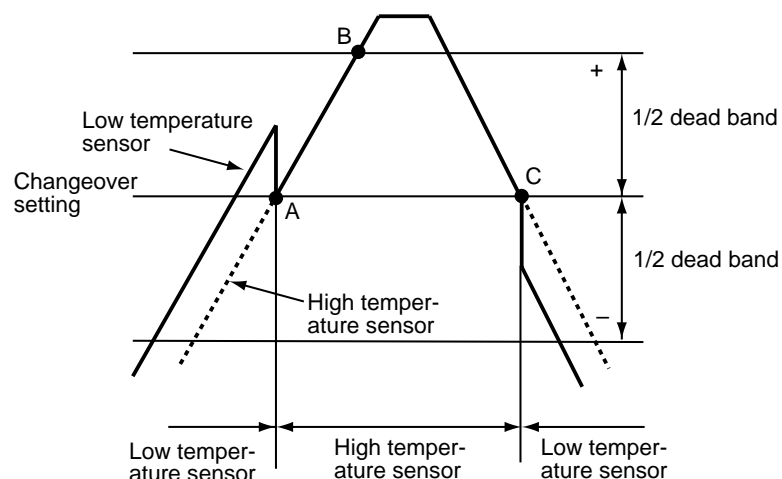

- (1) When the temperature rises and the high-temperature sensor senses that the temperature has risen to changeover point A, the channel switches from the low-temperature sensor to the high-temperature sensor.
- (2) When the high-temperature sensor senses that the temperature has risen above the upper limit of the dead band and reached point B, the channel switches from the high-temperature to the low-temperature sensor at changeover point C.

Example 3:

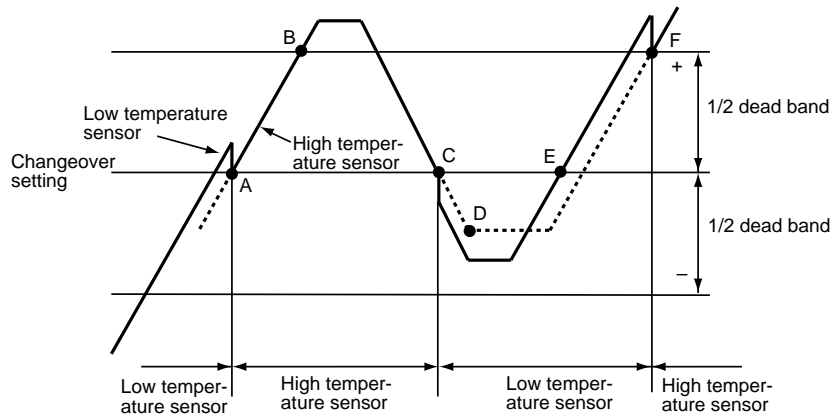

- (1) When the high-temperature sensor senses that the temperature has risen to changeover point A, the channel switches from the low-temperature to the high-temperature sensor.
- (2) When the high-temperature sensor senses that the temperature has risen above the upper limit of the dead band and reached point B, the channel switches from the high-temperature to the low-temperature sensor at changeover point C.
- (3) No switching is performed at changeover point E when the high-temperature sensor senses that the temperature has only dropped to point D and has not gone below the upper limit of the dead band.
- (4) When the high-temperature sensor senses that the temperature has reached point F at the upper limit of the dead band, the channel switches from the high-temperature to the low-temperature sensor at changeover point C.

Example 4:

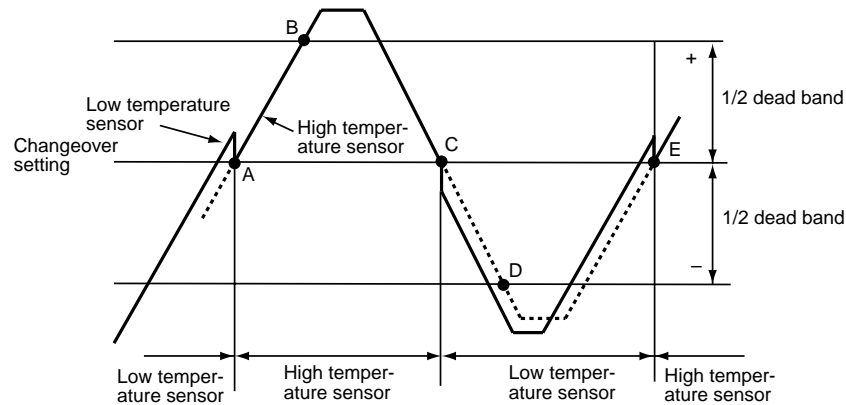

- (1) When the high-temperature sensor senses that the temperature has risen to changeover point A, the channel switches from the low-temperature to the high-temperature sensor.
- (2) When the high-temperature sensor senses that the temperature has risen above the upper limit of the dead band and reached point B, the channel switches from the high-temperature to the low-temperature sensor at changeover point C.
- (3) When the high-temperature sensor senses that the temperature has dropped to point D the lower limit of the dead band, the channel switches from the high-temperature to the low-temperature sensor at changeover point E.

- Automatic changeover B

To combine external switch input conditions with automatic changeover A, enter 2 in setup data setting C26 and 9 or 10 in one of settings C71 to C74. When 9 is entered in C71 to C74 and the external switch is on, it is tied to channel 1. When it is off, it is possible to switch channels from channel 1 to 2. When 10 is entered in C71 to C74 and the external switch is on, it is tied to channel 2. When it is off, it is possible to switch channels from channel 2 to 1.

Conditions	Result of automatic changeover A operation	CH1			CH2		
	External switch set to 9 (PV1 → PV2)	OFF	ON	Nothing	OFF	ON	Nothing
	External switch set to 10 (PV2 → PV1)	Nothing	OFF	ON	Nothing	OFF	ON
Result of automatic changeover B operation	CH1	CH1	CH2	CH2	CH1	CH2	

- Automatic changeover C

Enter 2 in setup data C26 when the PV to be calculated is the value between the low-temperature sensor and high-temperature sensor in the dead band range. The switch operation is described in the following example.

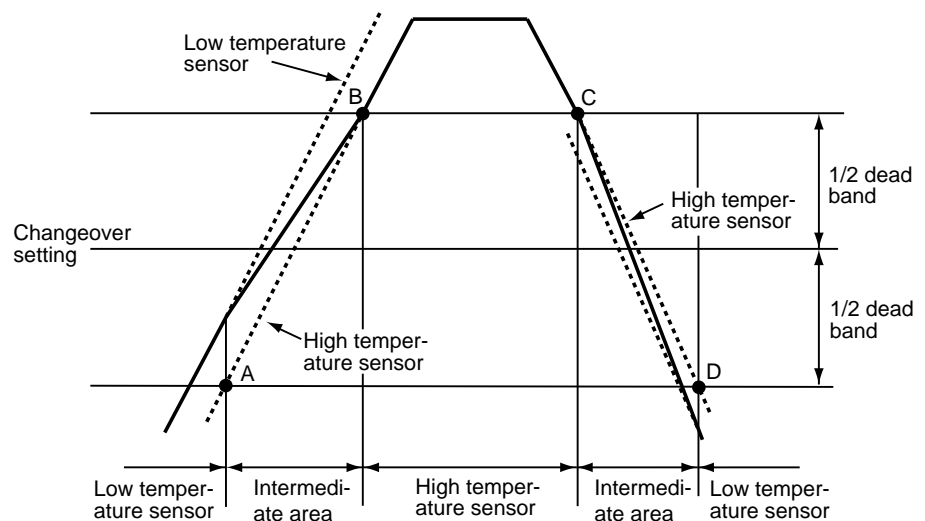

- (1) When the high-temperature sensor senses that the temperature has dropped below point A, the lower dead band limit, the channel switches from the high-temperature sensor to the low-temperature sensor.
- (2) When the high-temperature sensor senses that the temperature has risen to between point A, the lower dead band limit, and point B, the higher dead band limit, the controller calculates the value between the low-temperature sensor and the high-temperature sensor. The ratio of the high-temperature sensor varies between 0% at point A and 100% at point B.
- (3) When the high-temperature sensor senses that the temperature has risen above point B, the higher dead band limit, the channel switches from the low-temperature sensor to the high-temperature sensor.
- (4) When the high-temperature sensor senses that the temperature has dropped below point C and is going towards point D, the controller calculates the value between the low-temperature sensor and the high-temperature sensor.

 **NOTE**

- When switching between automatic changeover A to C, make sure that the changeover point is set in the overlapping area between the high-temperature and low-temperature sensors and 1/2 inside the deadband.

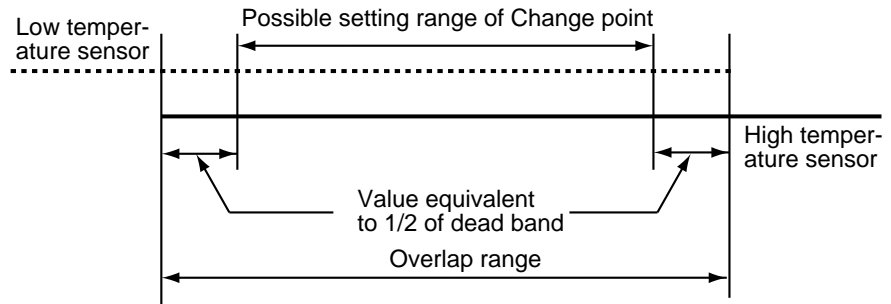

- When there is a temperature difference between the two inputs from high-temperature and low-temperature sensors, PV reflects this but the control output performs a PID computation to prevent a major disturbance from occurring. When a major disturbance occurs in the control output, select automatic changeover C.
- Select setup data setting **C29** when an initial changeover setting is desired at power on during automatic changeover A and B. When set to 0, the power stays off; when set to 1, a switch is made to CH1; and when set to 2 a switch is made to CH2.

5 - 6 Output Processing Functions

■ Control output

When the controller function is used, the control output is processed as shown below.

● 5G output (with setup data C21 set to 1)

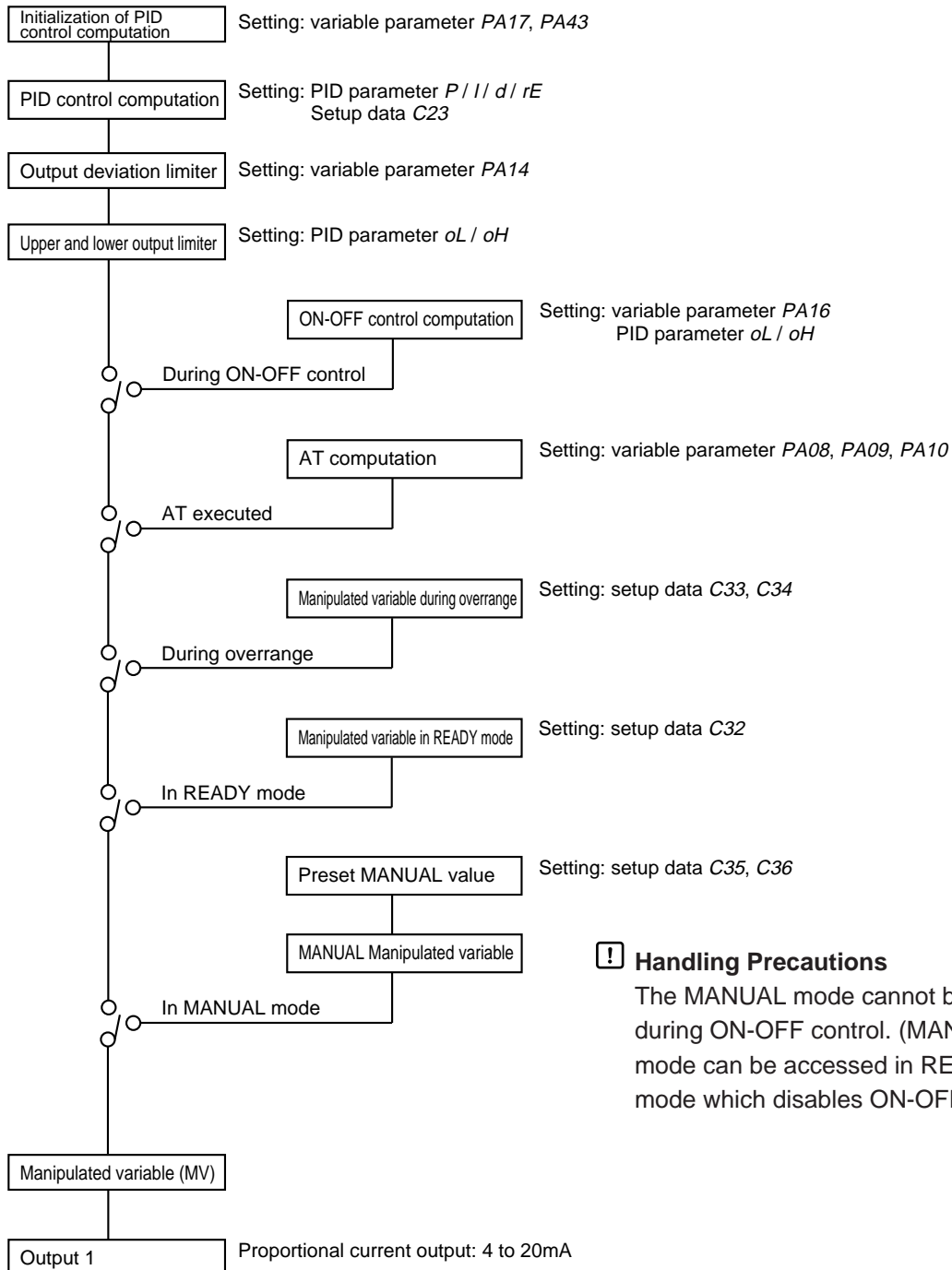

! Handling Precautions

The MANUAL mode cannot be invoked during ON-OFF control. (MANUAL mode can be accessed in READY mode which disables ON-OFF control.)

● 6D, 8D output (with setup data C21 set between 2 to 5)

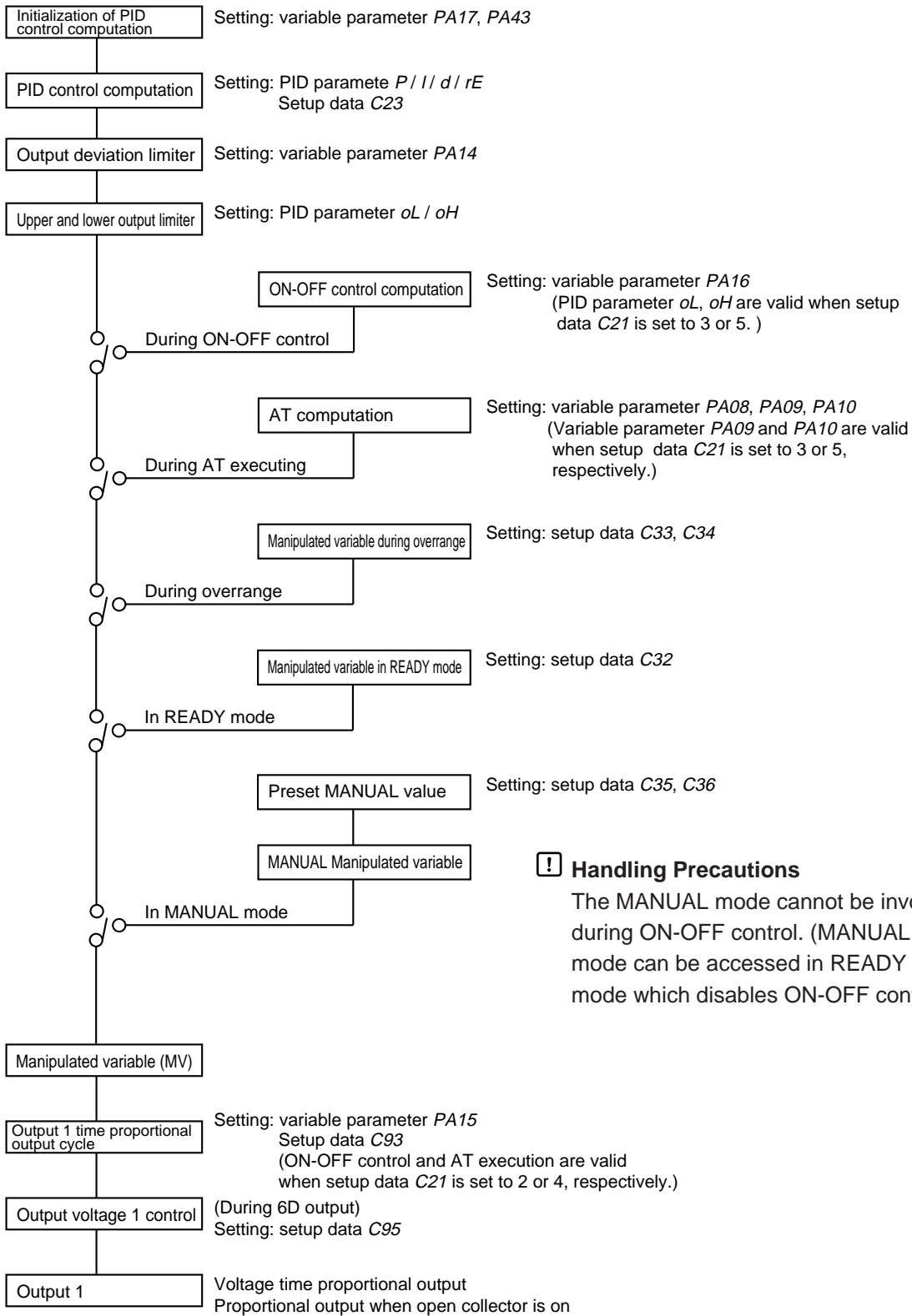

! Handling Precautions

The MANUAL mode cannot be invoked during ON-OFF control. (MANUAL mode can be accessed in READY mode which disables ON-OFF control.)

■ SP output

When the programmer function is used (when setup data *C21* is set to 0), SP output is processed as shown below.

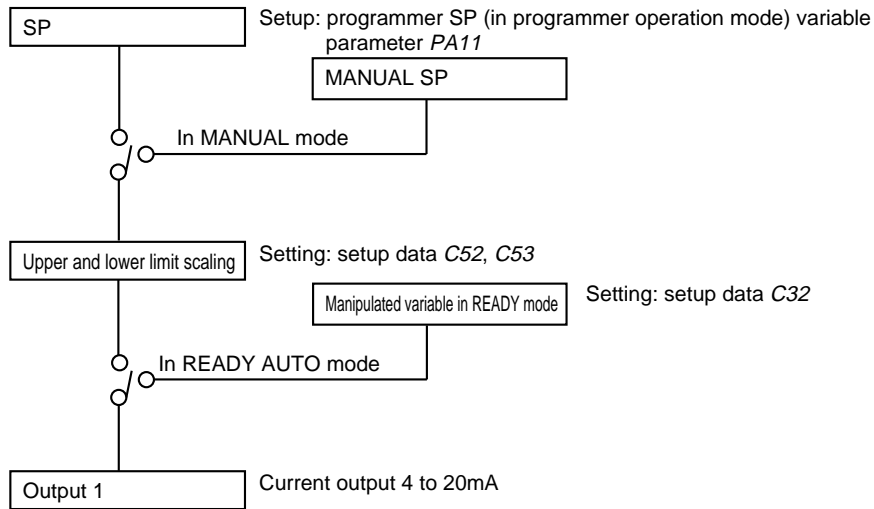

■ Auxiliary output

● Auxiliary output 1

Auxiliary output 1 is processed as shown below by a model with one or two auxiliary output channels.

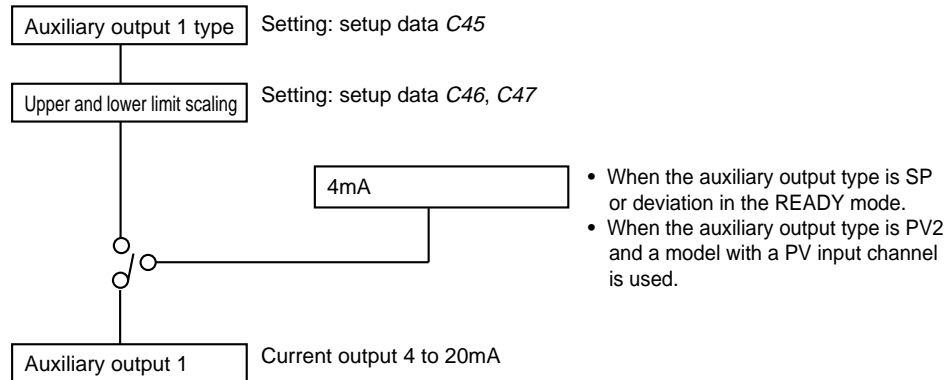

● Auxiliary output 2

Auxiliary output 2 is processed as shown below on a model with two auxiliary output channels.

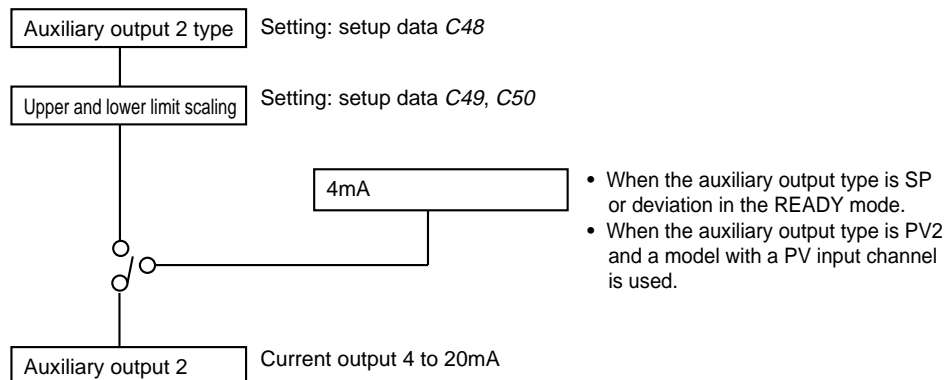

Chapter 6. OPERATION

6 - 1 Power Supply On

When 100 to 240Vac is applied across terminals (39) and (40) on the **DCP551**, the display goes on in about 10 seconds and controls and other operations start. When the controller is starting up, the LEDs on the profile display go on at irregular intervals one after the other starting from top right in clock-wise order until the controller becomes ready for operation.

The startup flow procedure is shown below.

● Startup flow procedure

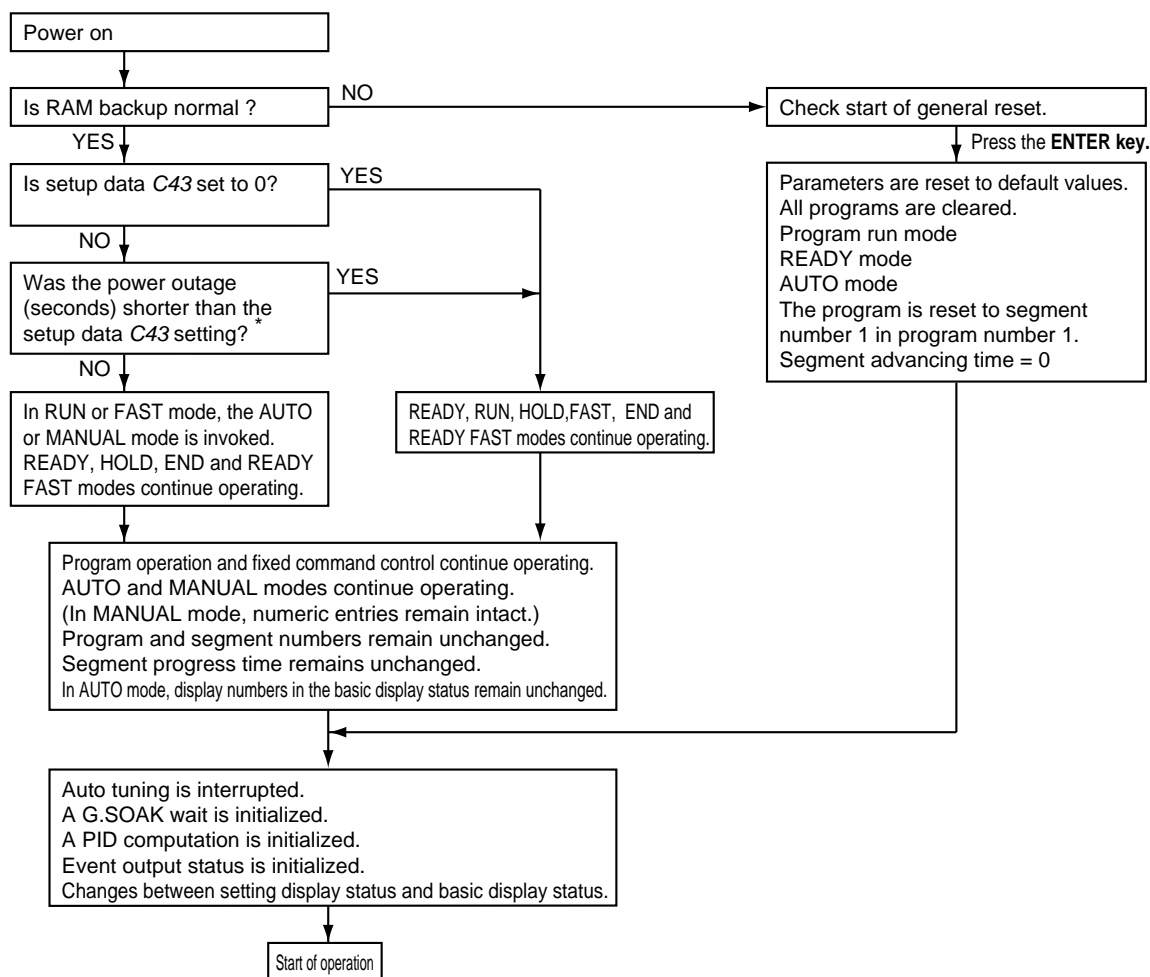

*: The measurement of a power outage may vary by about 10 seconds.

6 - 2 Basic Display Selection

The console basic display status is comprised of the program number display, segment number display, display panel 1, display panel 2, basic display LEDs and the message panel.

Use the **DISP key** or **MESSAGE key** to cycle through the different displays. The mode display LEDs perform the same functions both in the basic display status and during parameter settings and do not change by pressing the **DISP** or **MESSAGE key**.

The displays and their functions are shown in the figure below.

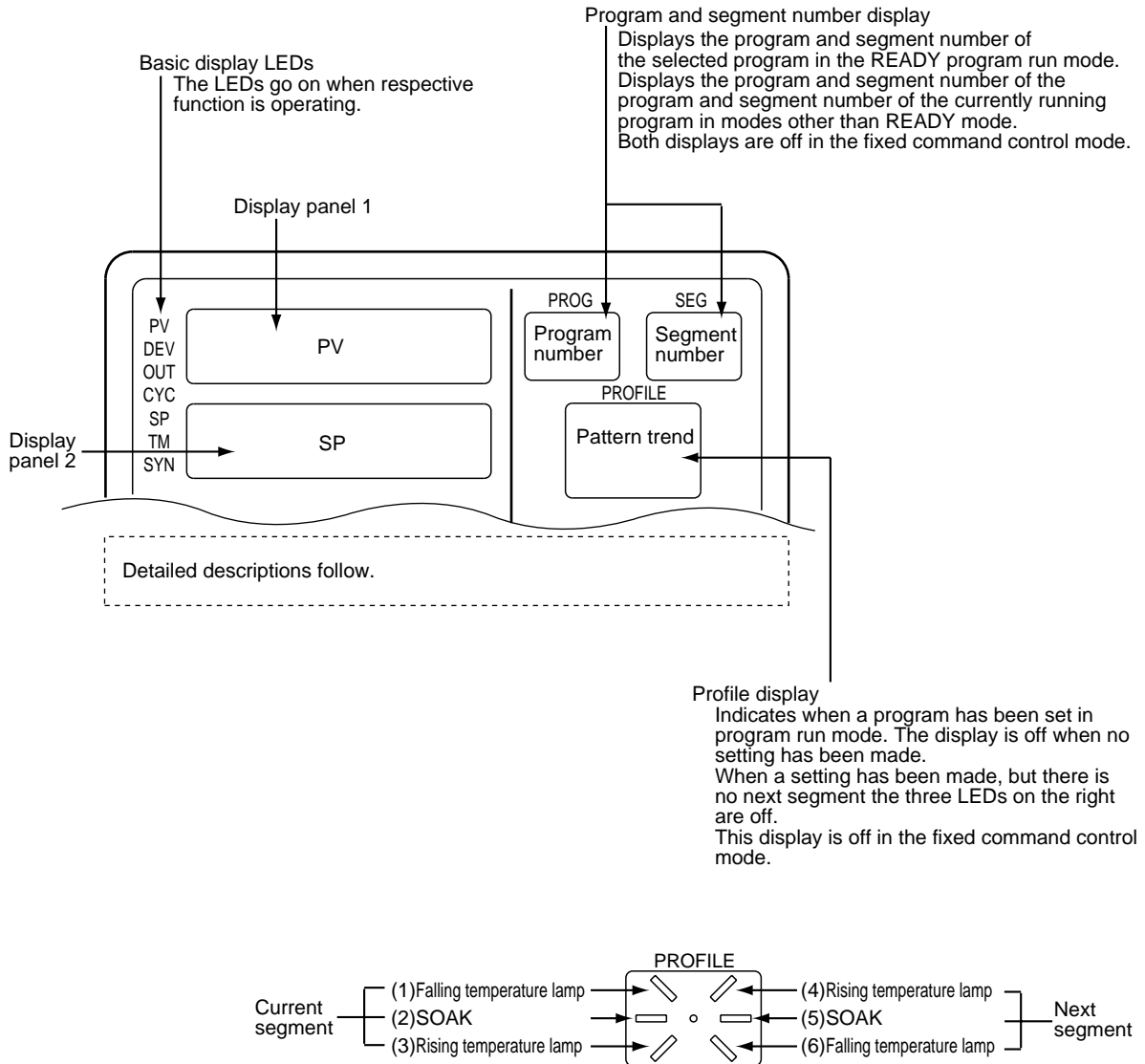

■ Program run mode displays

● DISP key function

The DISP key is used to cycle through the displays in the following order: Display A1, display A2, display A3, display A4, display A5, display A6, display A1.

● Display A1

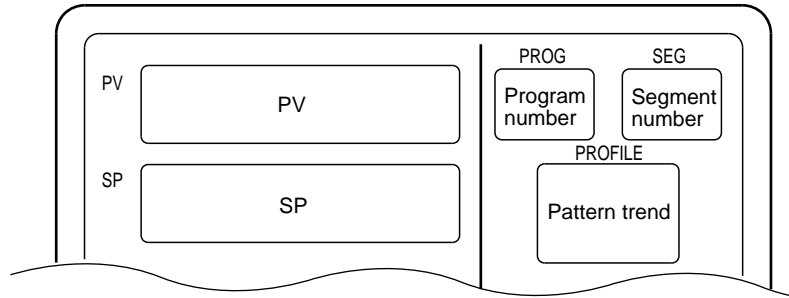

When the programmer function is used in MANUAL mode, the number of digits available for SP recording flashes.

● Display A2

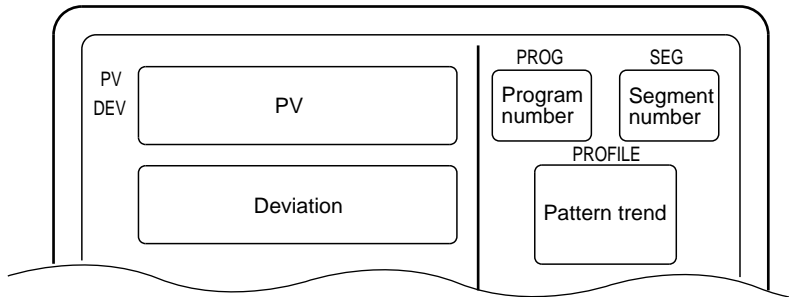

● Display A3

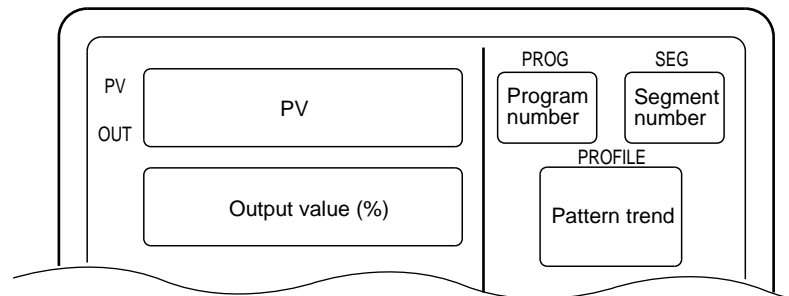

When the controller function is used in MANUAL mode, the number of digits available for output values flashes.

● Display A4

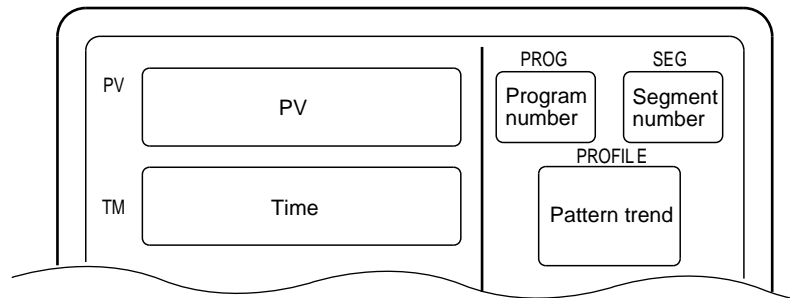

Select Hours and Minutes, Minutes and Seconds or 0.1 Seconds in the time unit setup data. In the setup data, also select Remaining Segment Time or Total Running Time.

● Display A5

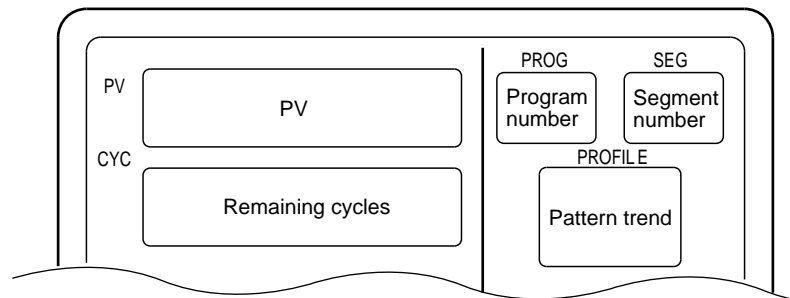

When the remaining number of cycles is 0, cycle operation stops.

● Display A6

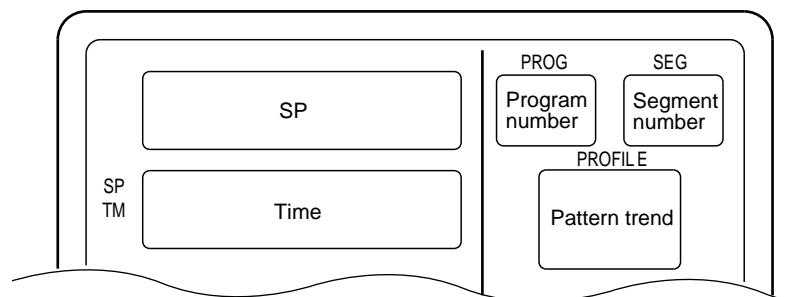

When the programmer function is used in MANUAL mode, the number of digits available for SP recording flashes. Select Hours and Minutes, Minutes and Seconds or 0.1 Seconds in the time unit setup data. In the setup data, also select Remaining Segment Time or Total Running Time.

● **Message key function**

Cycles through the message panel displays.

- Models with one PV input channel: Display B1, display B2, display B3, display B4, display B5, display B1.
- Models with two PV input channels: Display B1, display B2, display B3, display B4, display B5, display B6, display B1.

● **Display B1**

OUT 70 . 5 %OUT	←0 to 100% OUT graph ←—5 to 105% OUT value
--	---

● **Display B2**

DEV 3 . 1 % F S	←—5 to 5% FS graph ←—999.9 to 999.9% FS value
--	--

● **Display B3**

TIME 0 1 9 : 5 9 ▶ 1 8 0 : 0 1	←0 to 100% progress graph ←Time display in hours and minutes Elapsed time ▶ Remaining time
--	--

● **Display B4**

EVENT 1 - 1 6 	■ indicates that events are on and _ indicates that they are off. ← Displays events 1 to 8 from the left. ← Displays events 9 to 16 from the left.
--	---

● **Display B5**

TAG [P R O G 0 1]	←The [] displays the 8-character tag.
---------------------	--

● **Display B6**

P V C H 1 1 1 0 0 . 0 C H 2 1 0 5 0 . 0	←PV CH1 value ←PV CH2 value ■ indicates currently used channel. (In automatic switching C during intermediate CH1 and CH2 opera- tion, ■ is displayed for both.)
---	---

■ **Constant value control mode**

● **DISP key function**

The DISP key is used to cycle through the displays in the following order: Display C1, display C2, display C3, display C1.

● **Display C1**

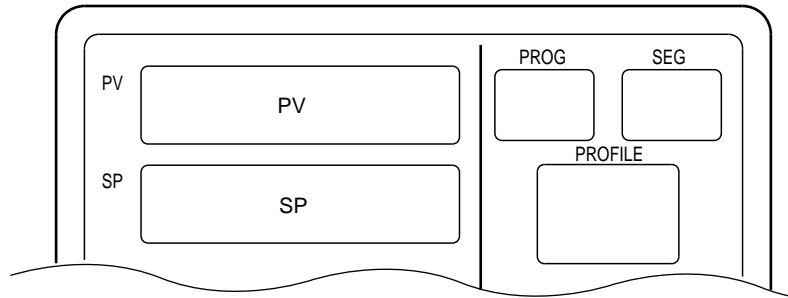

● **Display C2**

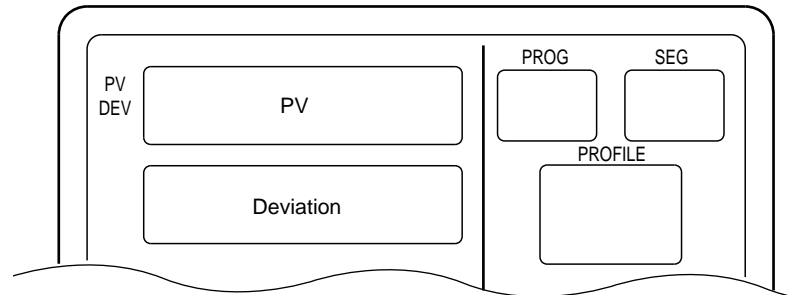

● **Display C3**

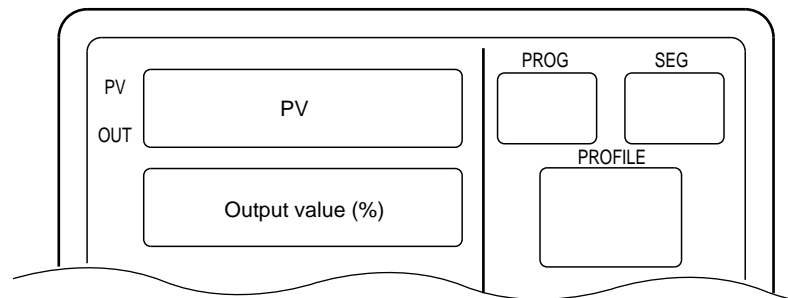

In MANUAL mode, the number of digits available for output values flash.

6 - 3 Selecting Programs

A total of 99 programs can be selected with the operation keys.

■ Selecting program numbers

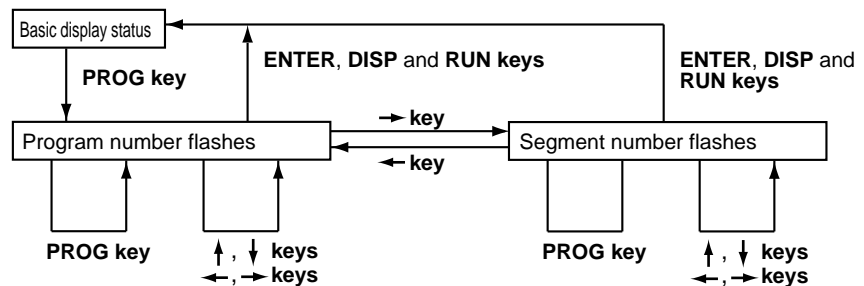

- Press the **PROG key** in the READY program run mode and basic display status. The program number starts to flash.
- Press the **PROG key** when the program or segment number starts flashing to cycle through set program numbers when several programs have been set. The segment number is set to 1.
- Use the **↑** or **↓ key** when the program number is flashing to select a program number regardless of whether a program has been set or not. The segment number is set to 1.
- Use the **↑** or **↓ key** when the segment number is flashing to select a segment number. When no program has been set, only 1 can be selected. When a program has been set, any of the set segments can be selected.
- The message panel displays the program tag when a program or segment number flashes. The 8-character tag display is off when no program has been set.
- Press the **RUN key** to start RUN mode operation from the displayed segment number when the program or segment number is flashing.

! Handling Precautions

- Programs cannot be selected during external switch input.
- Selections cannot be made in constant value control mode, RUN, HOLD, END and READY FAST modes.

6 - 4 External Switch Operation

External switch input

A total of 16 external switch inputs are available. Each input is called SW1, SW2, etc. up to SW16. (SW: external switch input)

Types of external switch inputs

SW1 to 4 and SW9 to 16 are tied.

SW5 to 8 functions are selected using setup data *C71* to *C74*.

SW9 to 16 are for program selections. Selections are made by entering BCD code or binary codes in setup data *C75*. When two weights are given for an item, the right weight is for binary figures and the left is for BCD.

External switch number	Function	Detection way
SW1	RUN	Leading edge
SW2	HOLD	Leading edge
SW3	RESET	Leading edge
SW4	ADV	Leading edge
SW5	Selects one of the following functions using setup settings.	
SW6	RAMP-E	Leading edge
SW7	FAST	Leading edge
SW8	Clears G.SOAK using the OR condition.	Status
	Clears G.SOAK using the AND condition.	Status
	MANUAL/AUTO	Leading/trailing edge
	AT start/stop	Leading/trailing edge
	PV1/PV2 (OFF: PV1, ON: PV2)	Status
	AUTO Loading (the DCP551A***** model only)	Leading edge
	PV1 → PV2 standby (See page 5-35.)	Status
PV2 → PV1 standby (See page 5-35.)	Status	
	Normal/Reverse operation	Status
SW9	Selects program number, weight 1	Status
SW10	Selects program number, weight 2	Status
SW11	Selects program number, weight 4	Status
SW12	Selects program number, weight 8	Status
SW13	Selects program number, weight 10 or 16	Status
SW14	Selects program number, weight 20 or 32	Status
SW15	Selects program number, weight 40 or 64	Status
SW16	Selects program number, weight 80 or 0	Status

NOTE

- When G.SOAK is cleared using an OR condition and an external switch is on, or PV enters the G.SOAK width, a G.SOAK wait is cleared.
- When G.SOAK is cleared using an AND condition and an external switch is on and PV enters the G.SOAK width, a G.SOAK wait is cleared.
- A normal or reverse operation is performed according to setup data setting *C23* when the external switch is off. When the external switch is on, a normal or reverse operation that is the reverse of setup data setting *C23* is performed.

■ Selecting programs

- Programs can be selected using the external switches in the READY program run mode.
- Programs are selected using the external switches and the BCD system or the binary system, and are set in setup data C75. In the BCD system, four switches SW9 to 12 are used to set the one digit and the four switches SW13 to 16 are used to set the ten digit. In the binary system, seven switches SW9 to 15 are used to set, and the switch SW16 is not used. Settings made with these systems are shown in the tables below.

BCD system (the one digit)		Status									
External switch number	Weight										
SW9	1	OFF	ON	OFF	ON	OFF	ON	OFF	ON	OFF	ON
SW10	2	OFF	OFF	ON	ON	OFF	OFF	ON	ON	OFF	OFF
SW11	4	OFF	OFF	OFF	OFF	ON	ON	ON	ON	OFF	OFF
SW12	8	OFF	OFF	OFF	OFF	OFF	OFF	OFF	OFF	ON	ON
Number selection		0	1	2	3	4	5	6	7	8	9

BCD system (the ten digit)		Status									
External switch number	Weight										
SW13	10	OFF	ON	OFF	ON	OFF	ON	OFF	ON	OFF	ON
SW14	20	OFF	OFF	ON	ON	OFF	OFF	ON	ON	OFF	OFF
SW15	40	OFF	OFF	OFF	OFF	ON	ON	ON	ON	OFF	OFF
SW16	80	OFF	OFF	OFF	OFF	OFF	OFF	OFF	OFF	ON	ON
Number selection		0	10	20	30	40	50	60	70	80	90

Binary system		Status												
External switch number	Weight													
SW9	1	OFF	ON	OFF	ON	OFF	ON		ON	OFF	ON	OFF	ON	
SW10	2	OFF	OFF	ON	ON	OFF	OFF		OFF	ON	ON	OFF	OFF	
SW11	4	OFF	OFF	OFF	OFF	ON	ON		ON	ON	ON	OFF	OFF	
SW12	8	OFF	OFF	OFF	OFF	OFF	OFF		ON	ON	ON	OFF	OFF	
SW13	16	OFF	OFF	OFF	OFF	OFF	OFF		OFF	OFF	OFF	ON	ON	
SW14	32	OFF	OFF	OFF	OFF	OFF	OFF		OFF	OFF	OFF	OFF	OFF	
SW15	64	OFF	OFF	OFF	OFF	OFF	OFF		OFF	OFF	OFF	OFF	OFF	
Number selection		0	1	2	3	4	5	•••	13	14	15	16	17	

Binary system		Status											
External switch number	Weight												
SW9	1		ON	OFF	ON		ON	OFF	ON		ON	OFF	ON
SW10	2		ON	OFF	OFF		ON	OFF	OFF		OFF	ON	ON
SW11	4		ON	OFF	OFF		ON	OFF	OFF		OFF	OFF	OFF
SW12	8		ON	OFF	OFF		ON	OFF	OFF		OFF	OFF	OFF
SW13	16		ON	OFF	OFF		ON	OFF	OFF		OFF	OFF	OFF
SW14	32		OFF	ON	ON		ON	OFF	OFF		ON	ON	ON
SW15	64		OFF	OFF	OFF		OFF	ON	ON		ON	ON	ON
Number selection		•••	31	32	33	•••	63	64	65	•••	97	98	99

! Handling Precautions

When a program number of 0 is set using the external switch inputs, programs can be selected using the console keys and by transmission.

■ Read timing

● SW1 to 8 timing

SW1 to 8 are read according to the timing in the figure shown below.

- (1) When the input changes from OFF to ON, reading starts within less than 0.2 seconds.
- (2) When the input changes from ON to OFF, reading starts within less than 0.2 seconds.

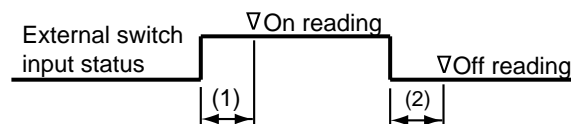

● SW9 to 16 and RUN, FAST (READY FAST) timing

Selecting SW9 to 16 program numbers takes less than 0.4 seconds after a change in input status.

Thus the following timings (1) to (4) must be observed during RUN operations. FAST (READY FAST) operations should follow the same timings.

- (1) Time from number selection to leading edge of the RUN signal : 0.4 seconds or more
- (2) Time from the leading edge of the RUN signal to number selection hold : 0.2 seconds or more
- (3) Time from RUN signal OFF to leading edge of RUN signal : 0.2 seconds or more
- (4) Time from leading edge of RUN signal to RUN signal ON hold : 0.2 seconds or more
- (5) Time from entry of selected number to program number change : 0.4 seconds or less
- (6) Time from leading edge of RUN signal to start of RUN signal : 0.4 seconds or less

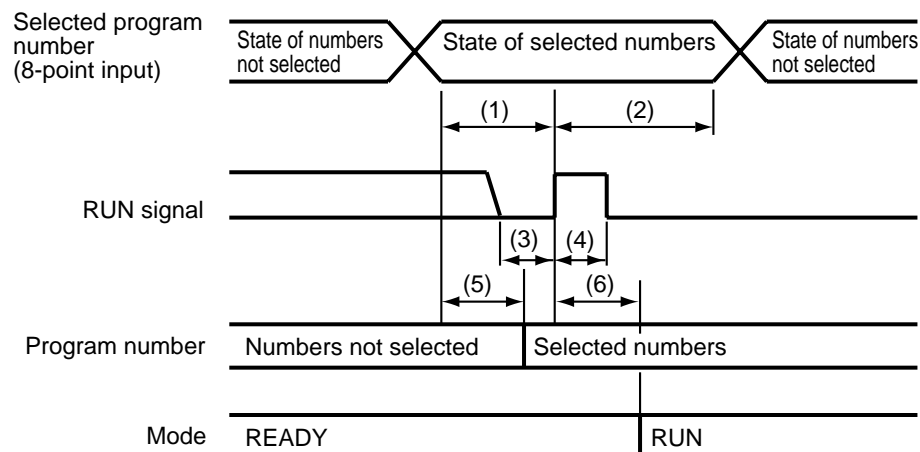

! Handling Precautions

To ensure correct operation, the above read timings should be regarded as minimum time settings in external switch operations.

6 - 5 Manual Operation and Auto-Tuning

■ Manual operation

The \uparrow and \downarrow **keys** can be used to control instrument outputs in the MANUAL mode.

● Controller function operations

When outputs are indicated in the basic display status, only one digit in the output value flashes. Increasing or decreasing the output value using \uparrow and \downarrow **keys** causes the actual output to change accordingly. Unlike setting registration, there is no need to press the **ENTER key**.

Use the \leftarrow and \rightarrow **keys** to move the flashing digit.

Setup data **C35** is used to select smooth and preset output changes when going from AUTO to MANUAL modes.

Changes from MANUAL to AUTO are smooth.

(Note, however, that when the integral time setting for a PID group PID parameter of 0 may cause abrupt changes.)

● Programmer function operations

SP can be set manually when setup data **C21** is set to 0 and programmer functions operate.

When SP is indicated in the basic display status, only one digit in the output value flashes. Increasing or decreasing the SP value using \uparrow and \downarrow **keys** causes the actual SP value to change accordingly. Unlike setting registration, there is no need to press the **ENTER key**.

Use the \leftarrow and \rightarrow **keys** to move the flashing digit.

Regardless of setup data **C35** setting, output changes going from AUTO to MANUAL modes are smooth.

Changes from MANUAL to AUTO program pattern SP are used and abrupt output changes may occur.

■ Auto-tuning (AT)

Set values can automatically be written when using auto-tuning (AT) in the RUN, HOLD, FAST and END modes during AUTO mode operation and PID groups (1 to 9, A1 to A7 or constant value control) are being used.

In READY AUTO mode, the tuning points of PID parameters *tP-A1* to *tP-A7* settings can be used as SP to perform auto-tuning of PID groups A1 to A7 values.

Variable parameter *PA08* allows the following selections:

- 0 : AT is not performed.
- 1 : A general AT operation of a PID group used in a mode other than READY mode
- 2 : AT of PID values that do not easily overshoot can be written to a PID group used in a mode other than READY mode.
- 3 : A standard AT operation is repeatedly performed on PID groups A1 to A7 in READY mode.
- 4 : Repeated AT of PID values that do not easily overshoot can be written to PID groups A1 to A7 used in READY mode.

- During auto-tuning, program run time stops. Thus the RUN and FAST modes are changed to the HOLD mode.

- Auto-tuning always calculates the excess time and limit sensitivity of thread for two limit cycles and calculates PID values using characteristics equations, then automatically writes the results.
- The setup data *C21* setting changes the upper and lower output limit used during auto-tuning.
C21 setting of 1, 3 or 5 causes the lower output limit to be determined by variable parameter *PA09* and the upper output limit to be determined by *PA10*.
C21 setting of 2 or 4, lower output limit is off and the upper output limit is on.
- The point at which output reverses (lower limit \leftrightarrow upper limit) during auto-tuning is determined from the SP and PV values at AT startup as follows.

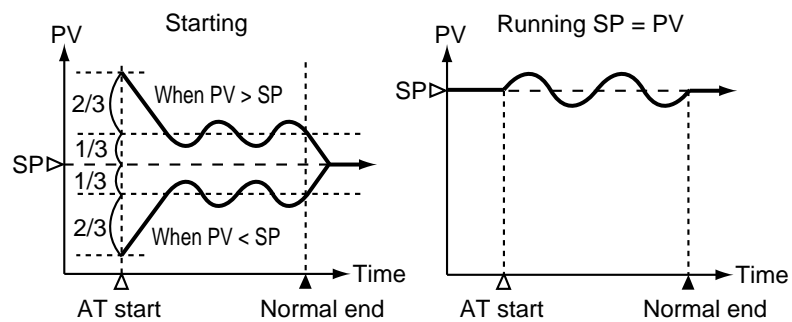

- Auto-tuning performed using a variable parameter *PA08* setting of 3 or 4 causes auto-tuning to be performed on SP, PID parameters *tP-A1* to *tP-A7*, in order.

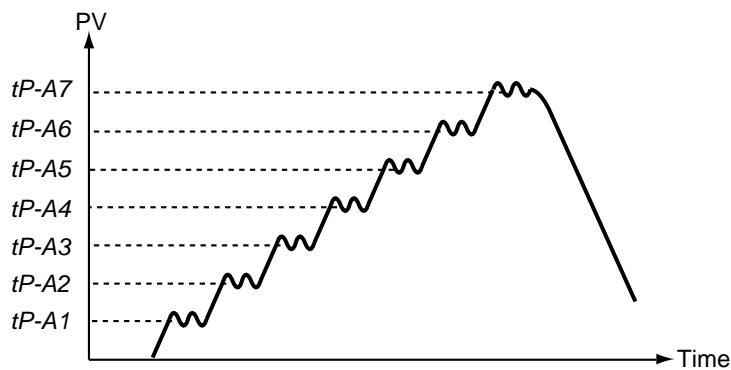

- Auto-tuning can be started by the **AT key**, external switch input and by transmission. The AT LED flashes during auto-tuning.
- Auto-tuning terminates without writing PID constants and the AT LED goes off when any of the following conditions occur.
 - Operation is terminated by pressing of the **AT key**.
 - Operation is terminated by an external switch input.
 - Operation is terminated by transmission.
 - Mode change occurs. (When the MANUAL mode is invoked; the READY mode is invoked by setting *PA08* to 1 or 2, the RUN mode is invoked by setting *PA08* to 3 or 4.)
 - When PV goes outside the range.

Handling Precautions

- Auto-tuning does not operate normally when the equipment to be controlled is not connected.
- The time required for auto-tuning depends on the equipment controlled.
- When auto-tuning is executed, control is terminated, lower and higher limit outputs are repeated several times and PV fluctuates. When equipment failure may be caused by PID fluctuations, set the PID value manually.
If just PID value can not be got in case of control object, sets PID value with manual.
- A variable parameter *PA08* setting makes values set at the start of auto-tuning valid. A change in the *PA08* setting made during auto-tuning execution is ignored. The new value is valid in the next auto-tuning operation.

Chapter 7. PARAMETER SETUP

7 - 1 Parameter Setup

Parameter settings can be changed when the **DCP551** is in the normal display mode.

When not in the normal display mode, press the **DISP key** to invoke it.

■ Selecting parameter settings groups

In the normal display mode, the keys listed in the table below can be used to select settings groups and individual items in these groups.

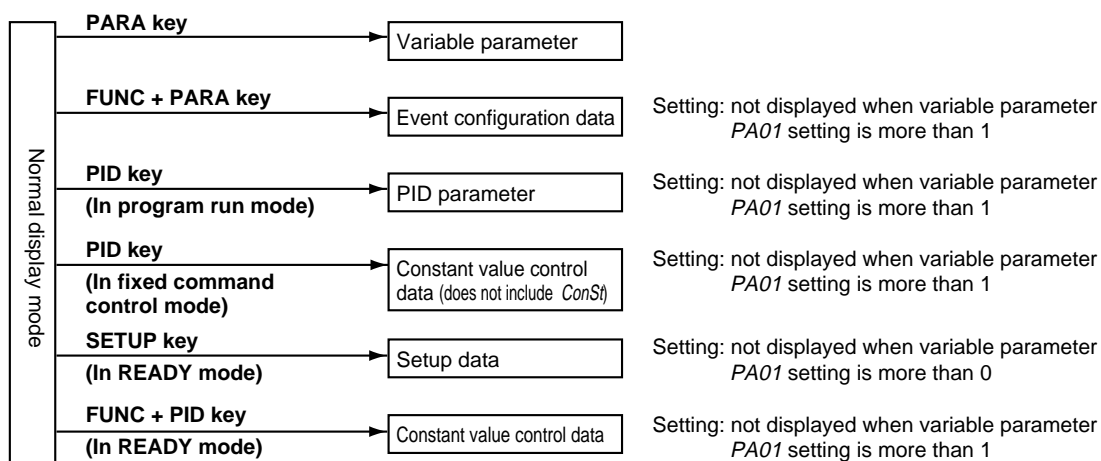

Individual items in each settings group are listed below.

Variable parameter : PA01

Event configuration data : E01-t

PID parameters : P-1 in READY mode

Use P setting in the used PID group in modes other than READY mode.

Setup data : C01

Constant value control data : ConSt when using **FUNC + PID key**

SP when using the **PID key** in constant value control mode

■ Progression of individual items in parameter settings

The item codes for individual (specific) items are shown on display panel 1, their set values are shown on display panel 2 and their mnemonic codes are shown on the message panel.

Individual items are displayed in the vertical-horizontal matrix shown on the following page, with matrix sizes varying according to settings group. The **↑ key**, **↓ key**, **← key** and **→ key** are used to cycle through individual items.

The **PARA key** (valid for variable parameters and event configuration data), **PID key** (valid for PID parameters and constant value control data) or the **SETUP key** (valid for setup data) allow you to search for displayable items in ascending order of item number.

■ Modifying individual items and exiting the setting mode

Pressing the **ENTER key** while an individual item is displayed causes the set value to flash and enables the registration state. At this point, the **↑ key** and **↓ key** allow you to increase or decrease the values, while the **← key** and **→ key** move the digit positions on the display at which the values flash.

Pressing the **ENTER key** after the flashing number has been changed to the desired value stops the flashing, the number reverts to the on state and the new setting is stored in internal memory.

Modification of settings is terminated by pressing either the **PARA key** (valid for variable parameters and event configuration data), **PID key** (valid for PID parameters and constant value control data), **SETUP key** (valid for setup data) or **DISP key**. Pressing the **PARA key**, **PID key** or **SETUP key** moves the cursor to the next item stops the flashing and the number reverts to its normal on state.

Pressing the **DISP key** enables the normal display mode.

Should display panel 2 show “----” during display of an individual item or pressing the **ENTER key** not enable the registration state, it means that settings cannot be made or modified for that item.

! Handling Precautions

- When *PA01* is set to more than 1 in a variable parameter setting, *PA03* and items beyond are not displayed. *PA03* and items beyond cannot be changed when *PA02* is set to 1 or more.
- Event configuration data settings cannot be changed when *PA02* is set to a value more than 1. Also, when *PA02* is set to 0 or 1, the event type setting and some auxiliary settings (output points of code events) cannot be changed.
- PID parameter settings cannot be changed when *PA02* is set to 4 or 5.
- Setup data settings cannot be changed when *PA02* is set to a value more than 1 and cannot be displayed in modes other than the READY mode.
- The fixed control data setting cannot be changed when *PA02* is set to 4 or 5. And, since the **FUNC** and **PID keys** are invalid in modes other than the READY mode, a *ConSt* setting cannot be displayed or changed.

• Example of individual item matrix (setup data)

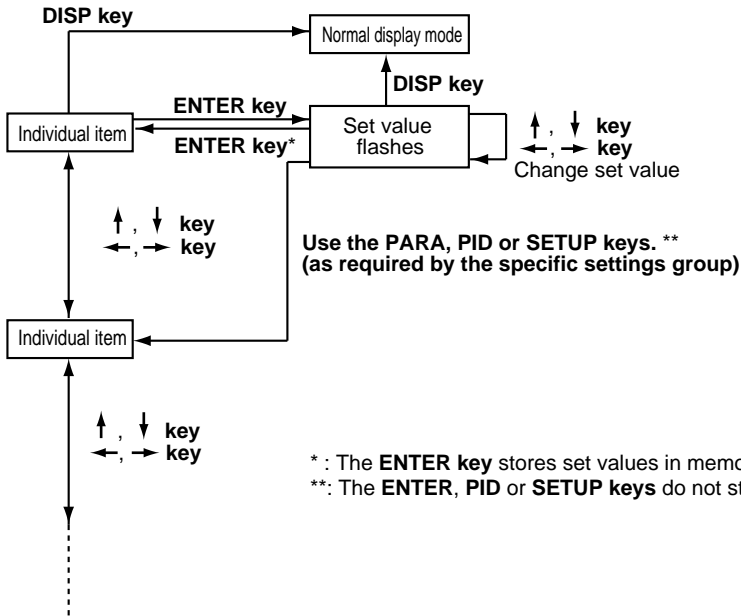
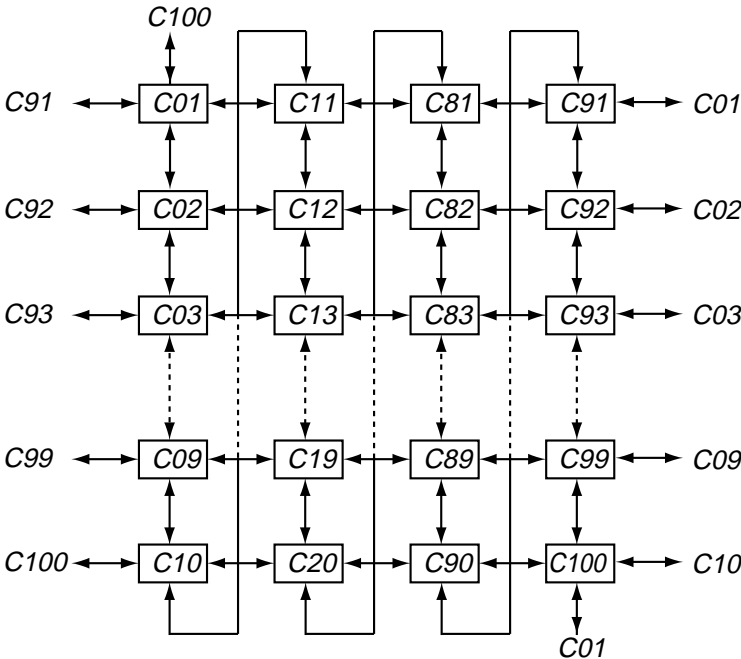

7 - 2 Parameter Setting List

 NOTE

“PVU (PV1)”, “PVU (PV2)” and “SPU” used in the “Factory Default Settings” and “User Settings” columns in the lists on the following pages have the following meaning.

PVU (PV1): When the PV1 range type (setup data setting *C01*) is a thermocouple or resistance temperature detector, the PV1 decimal point position (setup data setting *C03*) causes the decimal point position to change.
When the PV range type is linear, the PV1 linear decimal point position (setup data setting *C04*) causes the decimal point position to change.
For example, in a decimal point position of 1,
–19999 PVU (PV1) becomes –19999.9 and +20000 PVU (PV1) becomes +2000.0.

PVU (PV2): Like PVU (PV1), a PV2 range type (setup data setting *C11*), a PV2 decimal point position (setup data setting *C13*) and a PV2 linear decimal point position (setup data setting *C14*) causes the decimal point position to change.

SPU : The SPU decimal point position (setup data setting *C65*) causes the decimal point position to change.
For example a decimal point position of 2,
–19999 SPU becomes –199.99 and +20000 SPU becomes +200.00.

Variable parameter setting

No.	Item code	Item	Factory default settings	User settings	Settings and descriptions
1	PA 01	Keylock	0		0: Keylock disabled 1: Display of setup data settings disabled 2: Display of all settings disabled 3: Display of all settings disabled. Operation keys disabled [Description:] PA01 can be displayed and changed regardless of PA01 and PA02 settings.
2	PA 02	Memory protect	0		0: Disabled 1: Program settings are protected 2: Setup, variable parameters and event configurations are protected. 3: Setup, variable parameters and event configurations are protected. 4: Setup, variable parameters and event configurations are protected. 5: Program settings and all parameter settings are protected. [Description:] PA02 can be displayed and changed regardless of PA01 and PA02 settings.
3	PA 03	Unused	—		[Description:]
4	PA 04	Unused	—		“-----”is displayed and setting cannot be performed.
5	PA 05	Program auto load*	0		1: ON 2: OFF
6	PA 06	Unused	—		[Description:]
7	PA 07	Unused	—		“-----”is displayed and setting cannot be performed.
8	PA 08	Auto-tuning	0		0: AT not performed 1: Standard AT performed on currently used PID group in mode other than READY mode. 2: AT writing overshoot-proof PID values to currently used PID groups in mode other than READY mode performed. 3: Standard AT performed on PID groups A1 to A7 in READY mode. 4: AT writing overshoot-proof PID values to PID groups A1 to A7 in READY mode continuously performed.
9	PA 09	Auto-tuning MV lower limit	0.0		-5.0% to upper limit [Description:] Valid when setup data C21 setting is set to 1, 3, 5.
10	PA 10	Auto-tuning MV upper limit	100.0		Lower limit to +105% [Description:] Valid when setup data C21 setting is set to 1, 3, 5.
11	PA 11	SP bias	0 SPU		-10000 to +10000 SPU
12	PA 12	PV1 digital filter	0.0		0.0 to 120.0sec
13	PA 13	PV1 bias	0 PVU		-1000 to +1000 PVU (PV1)
14	PA 14	Manipulated variable deviation limit	110.0		0.1 to 110.0% OUT/0.1sec
15	PA 15	Time proportional output cycle	10		1 to 240sec
16	PA 16	On-off control differential	50 SPU		0 to +1000 SPU
17	PA 17	PID computation initialize manipulated variable	0.0		-5.0 to +105.0%
18	PA 18	Unused	-----		[Description:]
19	PA 19	Unused	-----		“-----”is displayed and setting cannot be performed.
20	PA 20	Unused	-----		
21	PA 21	Unused	-----		
22	PA 22	PV2 digital filter	0.0		0.0 to 120.0sec [Description:] “-----”is displayed and setting cannot be performed on model with one PV input channel.
23	PA 23	PV2 bias	0 PVU		-1000 to +1000 PVU (PV2) [Description:] “-----”is displayed and setting cannot be performed on model with one PV input channel.

* : This function is available on the DCP551A***** model only.

Chapter 7. PARAMETER SETUP

No.	Item code	Item	Factory default settings	User settings	Settings and descriptions
24	PA 24	Unused	-----		[Description:] ----- is displayed and setting cannot be performed.
25	PA 25	Unused	-----		
26	PA 26	Unused	-----		
27	PA 27	Unused	-----		
28	PA 28	Unused	-----		
29	PA 29	Unused	-----		
30	PA 30	Unused	-----		
31	PA 31	Event on delay Group 1 event number	0		0 to 16 [Description:] A setting of 0 generates no delay.
32	PA 32	Event on delay Group 1 delay time	0.0		0.0 to 3000.0sec [Description:] When PA31 is set to 0, ----- is displayed and setting cannot be performed.
33	PA 33	Event on delay Group 2 event number	0		0 to 16 [Description:] A setting of 0 generates no delay.
34	PA 34	Event on delay Group 2 delay time	0.0		0.0 to 3000.0sec [Description:] When PA33 is set to 0, ----- is displayed and setting cannot be performed.
35	PA 35	Event on delay Group 3 event number	0		0 to 16 [Description:] A setting of 0 generates no delay.
36	PA 36	Event on delay Group 3 delay time	0.0		0.0 to 3000.0sec [Description:] When PA35 is set to 0, ----- is displayed and setting cannot be performed.
37	PA 37	Event on delay Group 4 event number	0		0 to 16 [Description:] A setting of 0 generates no delay.
38	PA 38	Event on delay Group 4 delay time	0.0		0.0 to 3000.0sec [Description:] When PA37 is set to 0, ----- is displayed and setting cannot be performed.
39	PA 39	FAST X	0		0 : 2X 1 : 10X 2 : 60X 3 : 120X [Description:] When setup data C62 is set to 1 (program time unit: minutes, seconds), settings 3 and 4 produce a speed of 10 X. When C62 is set to 2 (program time unit: 0.1sec), the FAST mode is not available.
40	PA 40	Unused	-----		[Description:] ----- is displayed and setting cannot be performed.
41	PA 41	EG1 LED display event number	0		0 to 16 [Description:] A setting of 0 turns off the EG1 LED.
42	PA 42	EG2 LED display event number	0		0 to 16 [Description:] A setting of 0 turns off the EG2 LED.
43	PA 43	PID computation initialize	0		0: No initialization during advance processing and PID group change. 1: Initializes during advance processing but not during PID group change. 2: No initialization during advance processing but initializes during PID group change 3: Initializes both during advance processing and PID group change
44	PA 44	Unused	----		[Description:] ----- is displayed and setting cannot be performed.
45	PA 45	Unused	----		
46	PA 46	G.SOAK time	2.0		0.1 to 60.0sec
47	PA 47	Unused	----		
48	PA 48	Unused	----		
49	PA 49	Unused	----		

No.	Item code	Item	Factory default settings	User settings	Settings and descriptions
50	PA 50	Unused	----		<p>Compensation point No. 1 : PV1 range lower limit value (tied) Compensation points No. 2 to 9 : -19999 to +20000 PVU (PV1) Compensation point No. 10 : PV1 range upper limit value (tied) Compensation amount No. 1 to 10: -1000 to +1000 PVU (PV1) [Description:] When setup data C30 is set to 0, 2, ----- is displayed and setting cannot be performed. Compensation point No. 1 and No. 10 are automatically changed during a PV1 range change.</p>
51	PA 51	PV1 equalizer compensation point No. 1	Range lower limit value		
52	PA 52	PV1 equalizer compensation amount No. 1	0 PVU		
53	PA 53	PV1 equalizer compensation point No. 2	500 PVU		
54	PA 54	PV1 equalizer compensation amount No. 2	0 PVU		
55	PA 55	PV1 equalizer compensation point No. 3	1000 PVU		
56	PA 56	PV1 equalizer compensation amount No. 3	0 PVU		
57	PA 57	PV1 equalizer compensation point No. 4	1500 PVU		
58	PA 58	PV1 equalizer compensation amount No. 4	0 PVU		
59	PA 59	PV1 equalizer compensation point No. 5	2000 PVU		
60	PA 60	PV1 equalizer compensation amount No. 5	0 PVU		
61	PA 61	PV1 equalizer compensation point No. 6	2500 PVU		
62	PA 62	PV1 equalizer compensation amount No. 6	0 PVU		
63	PA 63	PV1 equalizer compensation point No. 7	3000 PVU		
64	PA 64	PV1 equalizer compensation amount No. 7	0 PVU		
65	PA 65	PV1 equalizer compensation point No. 8	3500 PVU		
66	PA 66	PV1 equalizer compensation amount No. 8	0 PVU		
67	PA 67	PV1 equalizer compensation point No. 9	4000 PVU		
68	PA 68	PV1 equalizer compensation amount No. 9	0 PVU		
69	PA 69	PV1 equalizer compensation point No. 10	Range upper limit value		
70	PA 70	PV1 equalizer compensation amount No. 10	0 PVU		
71	PA 71	PV2 equalizer compensation point No. 1	Range lower limit value		<p>Compensation point No. 2 : PV2 range lower limit value (tied) Compensation points No. 2 to 19 : -19999 to +20000 PVU (PV2) Compensation point No. 20 : PV2 range upper limit value (tied) Compensation amount No. 1 to 20 : -1000 to +1000 PVU (PV2) [Description:] When setup data C30 is set to 0, 1, ----- is displayed and setting cannot be performed. Compensation point No. 1 and No. 20 are automatically changed during a PV2 range change. Not displayed on a model with one PV input channel.</p>
72	PA 72	PV2 equalizer compensation amount No. 1	0 PVU		
73	PA 73	PV2 equalizer compensation point No. 2	500 PVU		
74	PA 74	PV2 equalizer compensation amount No. 2	0 PVU		
75	PA 75	PV2 equalizer compensation point No. 3	1000 PVU		
76	PA 76	PV2 equalizer compensation amount No. 3	0 PVU		
77	PA 77	PV2 equalizer compensation point No. 4	1500 PVU		
78	PA 78	PV2 equalizer compensation amount No. 4	0 PVU		
79	PA 79	PV2 equalizer compensation point No. 5	2000 PVU		
80	PA 80	PV2 equalizer compensation amount No. 5	0 PVU		
81	PA 81	PV2 equalizer compensation point No. 6	2500 PVU		
82	PA 82	PV2 equalizer compensation amount No. 6	0 PVU		
83	PA 83	PV2 equalizer compensation point No. 7	3000 PVU		
84	PA 84	PV2 equalizer compensation amount No. 7	0 PVU		
85	PA 85	PV2 equalizer compensation point No. 8	3500 PVU		
86	PA 86	PV2 equalizer compensation amount No. 8	0 PVU		
87	PA 87	PV2 equalizer compensation point No. 9	4000 PVU		
88	PA 88	PV2 equalizer compensation amount No. 9	0 PVU		
89	PA 89	PV2 equalizer compensation point No. 10	4500 PVU		
90	PA 90	PV2 equalizer compensation amount No. 10	0 PVU		
91	PA 91	PV2 equalizer compensation point No. 11	5000 PVU		
92	PA 92	PV2 equalizer compensation amount No. 11	0 PVU		
93	PA 93	PV2 equalizer compensation point No. 12	5500 PVU		
94	PA 94	PV2 equalizer compensation amount No. 12	0 PVU		
95	PA 95	PV2 equalizer compensation point No. 13	6000 PVU		
96	PA 96	PV2 equalizer compensation amount No. 13	0 PVU		

Chapter 7. PARAMETER SETUP

No.	Item code	Item	Factory default settings	User settings	Settings and descriptions	
97	PA 97	PV2 equalizer compensation point No. 14	6500 PVU			
98	PA 98	PV2 equalizer compensation amount No. 14	0 PVU			
99	PA 99	PV2 equalizer compensation point No. 15	7000 PVU			
100	PA100	PV2 equalizer compensation amount No. 15	0 PVU			
101	PA101	PV2 equalizer compensation point No. 16	7500 PVU			
102	PA102	PV2 equalizer compensation amount No. 16	0 PVU			
103	PA103	PV2 equalizer compensation point No. 17	8000 PVU			
104	PA104	PV2 equalizer compensation amount No. 17	0 PVU			
105	PA105	PV2 equalizer compensation point No. 18	8500 PVU			
106	PA106	PV2 equalizer compensation amount No. 18	0 PVU			
107	PA107	PV2 equalizer compensation point No. 19	9000 PVU			
108	PA108	PV2 equalizer compensation amount No. 19	0 PVU			
109	PA109	PV2 equalizer compensation point No. 20	Range upper limit value			
110	PA110	PV2 equalizer compensation amount No. 20	0 PVU			
111	PA111	PV1 ratio	1.000			0.001 to 9.999 [Description:] Not displayed on a model with one PV channel.
112	PA112	PV2 ratio	1.000			0.001 to 9.999 [Description:] Not displayed on a model with one PV channel.
113	PA113	Unused	-----			[Description:] Not displayed on a model with one PV input channel.
114	PA114	Unused	-----			Displays ----- on a model with two PV input channels.
115	PA115	Unused	-----			
116	PA116	Unused	-----			
117	PA117	Unused	-----			
118	PA118	Unused	-----			
119	PA119	Unused	-----			
120	PA120	Unused	-----			

■ Detailed information on variable parameters

● PA01 (keylock)

0: keylock disabled

1: display of setup data setting disabled

2: display of all settings disabled

3: display of all settings disabled. Operation keys disabled

- The following keys are disabled when *PA01* is set to 1.

Normal display mode:

SETUP key (setup data setting)

FUNC + CLR + MESSAGE keys (general reset)

- The following keys are disabled when *PA01* is set to 2.

Normal display mode:

SETUP key (setup data setting)

FUNC + CLR + MESSAGE keys (general reset)

FUNC + PARA keys (event configuration data setting)

PID key (PID parameter setting/constant value control data setting)

FUNC + PID keys (constant value control data setting)

FUNC + PROG keys (program setting)

↑ + PROG keys (program copy)

LOAD key (memory card load)

SAVE key (memory card save)

- The following keys are disabled when *PA01* is set to 3 or to 2.

Normal display mode:

PROG key (program selection)

RUN/HOLD key (RUN operation/HOLD operation)

PROG + RUN/HOLD keys (RESET operation)

PROG + DISP keys (ADV operation)

FUNC + → keys (FAST operation)

A/M key (AUTO operation/MANUAL operation)

AT key (AT start, AT cancel)

Note, however, that in the normal display mode in MANUAL mode MV (controller) and SP (programmer) can be changed.

● PA02 (memory protect)

0 : disabled

1 : program settings are protected

2 : setup, variable parameters and event configuration settings are protected

3 : setup, variable parameters, event configuration settings and program settings are protected

4 : setup, variable parameters, event configuration settings and PID parameter settings are protected

5 : program settings and all parameter settings are protected

- When *PA02* is set to $\neq 0$ (protect on), a general reset cannot be performed.

- When program settings are protected, it is not possible to copy programs or load programs from a memory card.
- When PID parameters are protected, constant value control data is also protected.
- When settings are protected by setup data, variable parameters, event configurations and PID parameters, they cannot be loaded from a memory card.

● **PA05 (program autoload)**

0 : OFF

1 : ON

- This function is available on the **DCP551A******* model only.
- When **PA05** is set to 1 and a memory card is inserted and press **LOAD key**, display panel 1 shows “*AUTO*”, display panel 2 shows “*LOAD*” and program file No. 1 is read to program No. 1 in the **DCP551**. This operation is called “program autoload”.
- A load operation other than a program autoload that is started using the **LOAD key** can only be performed when **PA05** is set to 0.
- A program autoload using the external switches can be performed when **PA05** is set to 0 or 1.

● **PA14 (manipulated variable deviation rate limit)**

When output deviation (%) after a PID computation is larger than the set limit value, the controller limits the output deviation both of the increase or decrease to the set value.

The following example shows the actual deviation change when the deviation limit is set to 0.5% and the manipulated variable changes from 20% to 22%. When the set value is 0.5% per 0.1 sec, the output becomes 22% after 0.4 sec.

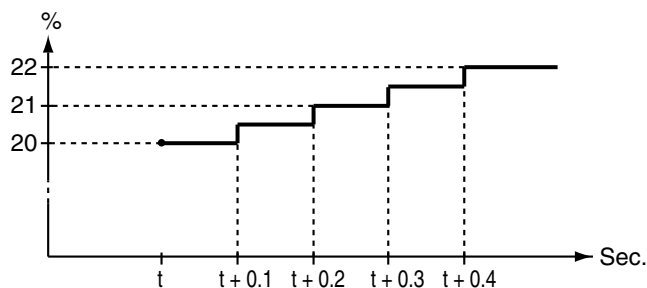

● **PA16 (ON-OFF control differential)**

When the PID group number is set to ON-OFF or *P* is set to 0.0, ON-OFF control is on and a value for the differential between the two operations is set.

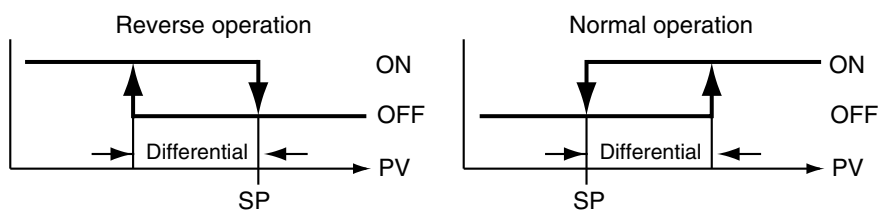

● **PA17 (PID computation initialize manipulated variable)**

Under the conditions listed below, a PID computation starts using the value set in *PA17*.

- When there is a mode change from READY AUTO to RUN AUTO.
- When the controller is powered up in RUN (or HOLD, FAST, END) AUTO mode.
- When auto-tuning ends.

Since the PV, SP and PID parameters affect a PID computation, the first manipulated variable of a PID computation may not be the same as the value set in *PA17*.

● **PA31 to PA38 (event on delay groups 1 to 4, event/delay time)**

- On delay can be performed on up to 4 events.
- *PA31*, *PA33*, *PA35* and *PA37* determine which events are to be processed.
- In a code event involving several event outputs, event on delay has to be set separately for each output.
- All processes including event output standby on/off are processed before on delay processing. When the event output ON condition remains on for longer than the on delay time, the event output stays on.
- This is shown in the diagram below.

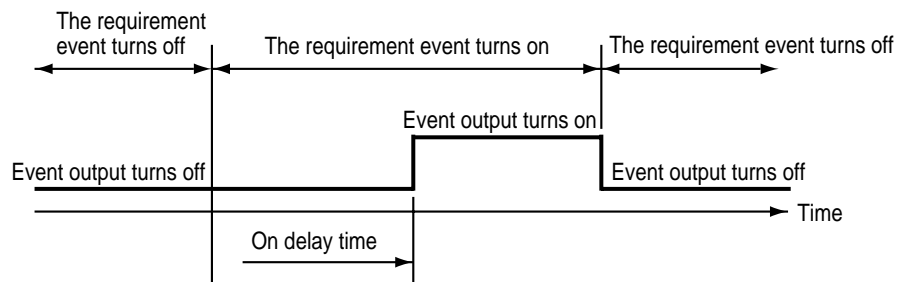

● **PA41 (EG1 LED display event number)**

The console EG1 LED lights when an event number set in *PA41* goes on and is off when it goes off. Note, however, that the EG1 LED is off when *PA41* is set to 0.

● **PA42 (EG2 LED display event number)**

The console EG2 LED lights when an event number set in *PA42* goes on and is off when it goes off. Note, however, that the EG2 LED is off when *PA42* is set to 0.

● **PA43 (PID computation initialize)**

When SP changes abruptly due to ADV, the derivative action of a PID computation, may cause an excessive change in the manipulated variable of the computation.

For this reason, the initialization of a PID computation is performed to suppress an excessive change.

But the initialization of a PID computation means that PID computation continuity is lost which may affect operating conditions. A *PA43* setting allows the user to turn on or off initialization and determine its conditions.

■ Event configuration data settings

No.	Item code	Item	Factory default settings	User settings	Settings and descriptions
1	<i>E01-t</i>	Event 1 event type	0		The event type setting of each event determines whether auxiliary setting 1 or auxiliary setting 2 is on or off, their meaning, unit and range. For details, see ■ Settings by event type on the following pages.
2	<i>E01-1</i>	Event 1 auxiliary setting 1	----		
3	<i>E01-2</i>	Event 1 auxiliary setting 2	----		
4	<i>E02-t</i>	Event 2 event type	0		
5	<i>E02-1</i>	Event 2 auxiliary setting 1	----		
6	<i>E02-2</i>	Event 2 auxiliary setting 2	----		
7	<i>E03-t</i>	Event 3 event type	0		
8	<i>E03-1</i>	Event 3 auxiliary setting 1	----		
9	<i>E03-2</i>	Event 3 auxiliary setting 2	----		
10	<i>E04-t</i>	Event 4 event type	0		
11	<i>E04-1</i>	Event 4 auxiliary setting 1	----		
12	<i>E04-2</i>	Event 4 auxiliary setting 2	----		
13	<i>E05-t</i>	Event 5 event type	0		
14	<i>E05-1</i>	Event 5 auxiliary setting 1	----		
15	<i>E05-2</i>	Event 5 auxiliary setting 2	----		
16	<i>E06-t</i>	Event 6 event type	0		
17	<i>E06-2</i>	Event 6 auxiliary setting 1	----		
18	<i>E06-3</i>	Event 6 auxiliary setting 2	----		
19	<i>E07-t</i>	Event 7 event type	0		
20	<i>E07-1</i>	Event 7 auxiliary setting 1	----		
21	<i>E07-2</i>	Event 7 auxiliary setting 2	----		
22	<i>E08-t</i>	Event 8 event type	0		
23	<i>E08-1</i>	Event 8 auxiliary setting 1	----		
24	<i>E08-2</i>	Event 8 auxiliary setting 2	----		
25	<i>E09-t</i>	Event 9 event type	0		
26	<i>E09-1</i>	Event 9 auxiliary setting 1	----		
27	<i>E09-2</i>	Event 9 auxiliary setting 2	----		
28	<i>E10-t</i>	Event 10 event type	0		
29	<i>E10-1</i>	Event 10 auxiliary setting 1	----		
30	<i>E10-2</i>	Event 10 auxiliary setting 2	----		
31	<i>E11-t</i>	Event 11 event type	0		
32	<i>E11-1</i>	Event 11 auxiliary setting 1	----		
33	<i>E11-2</i>	Event 11 auxiliary setting 2	----		
34	<i>E12-t</i>	Event 12 event type	0		
35	<i>E12-1</i>	Event 12 auxiliary setting 1	----		
36	<i>E12-2</i>	Event 12 auxiliary setting 2	----		
37	<i>E13-t</i>	Event 13 event type	0		
38	<i>E13-1</i>	Event 13 auxiliary setting 1	----		
39	<i>E13-2</i>	Event 13 auxiliary setting 2	----		
40	<i>E14-t</i>	Event 14 event type	0		
41	<i>E14-1</i>	Event 14 auxiliary setting 1	----		
42	<i>E14-2</i>	Event 14 auxiliary setting 2	----		
43	<i>E15-t</i>	Event 15 event type	0		
44	<i>E15-1</i>	Event 15 auxiliary setting 1	----		
45	<i>E15-2</i>	Event 15 auxiliary setting 2	----		
46	<i>E16-t</i>	Event 16 event type	0		
47	<i>E16-1</i>	Event 16 auxiliary setting 1	----		
48	<i>E16-2</i>	Event 16 auxiliary setting 2	----		

■ Settings by event type

For information on event operations, see “■ Events” (pages 5-5 to 5-15).

Event type	0	1	2	3
Meaning Message	Event off OFF	Time event TIME	PV upper limit PV-H	PV lower limit PV-L
Range of auxiliary setting 1 Message	Unused	Unused	Hysteresis 0 to 1000 SPU hysteresis	Hysteresis 0 to 1000 SPU hysteresis
Range of auxiliary setting 2 Message	Unused	Unused	Unused	Unused
Setting category Operation category	— —	Segment type Time type	Segment type PV type	Segment type PV type

Event type	4	5	6	7
Meaning Message	Upper deviation limit DEV-H	Lower deviation limit DEV-L	Deviation rate upper limit wait DEV-H-W	Deviation lower limit with stanby DEV-L-W
Range of auxiliary setting 1 Message	Hysteresis 0 to 1000 SPU hysteresis	Hysteresis 0 to 1000 SPU hysteresis	Hysteresis 0 to 1000 SPU hysteresis	Hysteresis 0 to 1000 SPU hysteresis
Range of auxiliary setting 2 Message	Unused	Unused	Unused	Unused
Setting category Operation category	Segment type PV type	Segment type PV type	Segment type PV type	Segment type PV type

Event type	8	9	10	11
Meaning Message	Absolute value deviation upper limit A-DEV-H	Absolute value deviation lower limit A-DEV-L	Absolute value deviation rate upper limit with stanby A-DEV-H-W	Absolute value deviation lower limit with stanby A-DEV-L-W
Range of auxiliary setting 1 Message	Hysteresis 0 to 1000 SPU hysteresis	Hysteresis 0 to 1000 SPU hysteresis	Hysteresis 0 to 1000 SPU hysteresis	Hysteresis 0 to 1000 SPU hysteresis
Range of auxiliary setting 2 Message	Unused	Unused	Unused	Unused
Setting category Operation category	Segment type PV type	Segment type PV type	Segment type PV type	Segment type PV type

Event type	12	13	14	15
Meaning Message	PV deviation rate upper limit A-DEV-H	PV deviation rate lower limit D-PV-L	SP upper limit SP-H	SP lower limit SP-L
Range of auxiliary setting 1 Message	Sampling cycle 0.1 to 600.0sec sampling rate	Sampling cycle 0.1 to 600.0sec sampling rate	Hysteresis 0 to 1000 SPU hysteresis	Hysteresis 0 to 1000 SPU hysteresis
Range of auxiliary setting 2 Message	Unused	Unused	Unused	Unused
Setting category Operation category	Segment type PV type	Segment type PV type	Segment type PV type	Segment type PV type

Chapter 7. PARAMETER SETUP

Event type	16	17	18	19
Meaning Message	MV upper limit MV-H	MV lower limit MV-L	Code event CODE	SOAK absolute value deviation upper limit S-A-DEV-H
Range of auxiliary setting 1 Message	Hysteresis 0.0 to 100.0% hysteresis	Hysteresis 0.0 to 100.0% hysteresis	Number of output points 1 to 8 ^{*1} channels	Hysteresis 0 to 1000 SPU hysteresis
Range of auxiliary setting 2 Message	Unused	Unused	Unused	Unused
Setting category Operation category	Segment type PV type	Segment type PV type	Segment type Code type	Segment type PV type

*1: Code event auxiliary setting 1 (number of output points) can be changed only in the READY mode.

Event type	20	21	22	23
Meaning Message	SOAK absolute value deviation lower limit S-A-DEV-L	SOAK absolute value deviation upper limit with stanby S-A-DEV-H-W	SOAK absolute value deviation lower limit with stanby S-A-DEV-L-W	Timer code event T-CODE
Range of auxiliary setting 1 Message	Hysteresis 0 to 1000 SPU hysteresis	Hysteresis 0 to 1000 SPU hysteresis	Hysteresis 0 to 1000 SPU hysteresis	Number of output points 1 to 8 ^{*2} channels
Range of auxiliary setting 2 Message	Unused	Unused	Unused	Unused
Setting category Operation category	Segment type PV type	Segment type PV type	Segment type PV type	Segment type Time type, code type

*2: Auxiliary setting 1 (number of output points) can be changed only in the READY mode.

Event type	24 to 63	64	65	66
Meaning Message	Event off OFF	Normal PV1 upper limit operation PV1-H	Normal PV1 lower limit operation PV1-L	Normal PV2 upper limit operation V2-H
Range of auxiliary setting 1 Message	Unused	Hysteresis 0 to 1000 SPU hysteresis	Hysteresis 0 to 1000 SPU hysteresis	Hysteresis 0 to 1000 SPU hysteresis
Range of auxiliary setting 2 Message	Unused	Operating point -19999 to +20000 SPU set point	Operating point -19999 to +20000 SPU set point	Operating point -19999 to +20000 SPU set point
Setting category Operation category	— —	Instrument type PV type	Instrument type PV type	Instrument type PV type

Event type	67	68	69	70
Meaning Message	Normal PV2 upper limit operation PV2-L	PV upper limit PV-H	PV lower limit PV-L	Deviation upper limit DEV-H
Range of auxiliary setting 1 Message	Hysteresis 0 to 1000 SPU hysteresis	Hysteresis 0 to 1000 SPU hysteresis	Hysteresis 0 to 1000 SPU hysteresis	Hysteresis 0 to 1000 SPU hysteresis
Range of auxiliary setting 2 Message	Operating point -19999 to +20000 SPU set point	Operating point -19999 to +20000 SPU set point	Operating point -19999 to +20000 SPU set point	Operating point -19999 to +20000 SPU set point
Setting category Operation category	Instrument type PV type	Instrument type PV type	Instrument type PV type	Instrument type PV type

Event type	71	72	73	74
Meaning Message	Deviation lower limit DEV-L	Deviation upper limit wait DEV-H-W	Deviation lower limit wait DEV-L-W	Absolute value deviation upper limit A-DEV-H
Range of auxiliary setting 1 Message	Hysteresis 0 to 1000 SPU hysteresis	Hysteresis 0 to 1000 SPU hysteresis	Hysteresis 0 to 1000 SPU hysteresis	Hysteresis 0 to 1000 SPU hysteresis
Range of auxiliary setting 2 Message	Operating point -19999 to +20000 SPU set point	Operating point -19999 to +20000 SPU set point	Operating point -19999 to +20000 SPU set point	Operating point 0 to 20000 SPU set point
Setting category Operation category	Instrument type PV type	Instrument type PV type	Instrument type PV type	Instrument type PV type

Event type	75	76	77	78
Meaning Message	Absolute value deviation lower limit A-DEV-L	Absolute value deviation upper limit with standby A-DEV-H-W	Absolute value deviation lower limit with standby A-DEV-L-W	PV deviation rate upper limit D-PV-H
Range of auxiliary setting 1 Message	Hysteresis 0 to 1000 SPU hysteresis	Hysteresis 0 to 1000 SPU hysteresis	Hysteresis 0 to 1000 SPU hysteresis	Sampling cycle 0.1 to 600.0 sec sampling rate
Range of auxiliary setting 2 Message	Operating point 0 to 20000 SPU set point	Operating point 0 to 20000 SPU set point	Operating point 0 to 20000 SPU set point	Operating point —19999 to +20000 SPU set point
Setting category Operation category	Instrument type PV type	Instrument type PV type	Instrument type PV type	Instrument type PV type

Event type	79	80	81	82
Meaning Message	PV deviation rate lower limit D-PV-L	SP upper limit SP-H	SP lower limit SP-L	MV upper limit MV-H
Range of auxiliary setting 1 Message	Sampling cycle 0.1 to 600.0sec sampling rate	Hysteresis 0 to 1000 SPU hysteresis	Hysteresis 0 to 1000 SPU hysteresis	Hysteresis 0.0 to 100.0% hysteresis
Range of auxiliary setting 2 Message	Operating point -19999 to +20000 SPU set point	Operating point -19999 to +20000 SPU set point	Operating point -19999 to +20000 SPU set point	Operating point -5.0 to +105.0% set point
Setting category Operation category	Instrument type PV type	Instrument type PV type	Instrument type PV type	Instrument type PV type

Event type	83	84	85	86
Meaning Message	MV lower limit MV-L	SOAK absolute value deviation upper limit S-A-DEV-H	SOAK absolute value deviation lower limit S-A-DEV-L	SOAK absolute value deviation upper limit with standby S-A-DEV-H-W
Range of auxiliary setting 1 Message	Hysteresis 0.0 to 100.0% hysteresis	Hysteresis 0 to 1000 SPU hysteresis	Hysteresis 0 to 1000 SPU hysteresis	Hysteresis 0 to 1000 SPU hysteresis
Range of auxiliary setting 2 Message	Operating point -5.0 to +105.0% set point	Operating point 0 to 20000 SPU set point	Operating point 0 to 20000 SPU set point	Operating point 0 to 20000 SPU set point
Setting category Operation category	Instrument type PV type	Instrument type PV type	Instrument type PV type	Instrument type PV type

Event type	87	88	89	90
Meaning Message	SOAK absolute value deviation lower limit with standby S-A-DEV-L-W	Program number binary code PROG-BIN	Segment number binary code SEG-BIN	Program number BCD code PROG-BCD
Range of auxiliary setting 1 Message	Hysteresis 0 to 1000 SPU hysteresis	Number of output points 1 to 7 channels	Number of output points 1 to 7 channels	Number of output points 1 to 8 channels
Range of auxiliary setting 2 Message	Operating point 0 to 20000 SPU set point	Unused	Unused	Unused
Setting category Operation category	Instrument type PV type	Instrument type Code type	Instrument type Code type	Instrument type Code type

Event type	91	92	93	94
Meaning	Segment number BCD code	Special segment	RAMP-E time monitoring	Segment time
Message	SEG-BCD	SEG SEQUENCE	RAMP-E TIME OUT	SEG TIME
Range of auxiliary setting 1 Message	Number of output points 1 to 8 channels	Segment specification -2 to +2 ^{*1} segment	Operating point 0.0 to 3000.0sec ^{*2} time out	On Time 0:00 to 500:00 ^{*3} on-time
Range of auxiliary setting 2 Message	Unused	Unused	Unused	Off Time 0:00 to 500:00 ^{*3} off-time
Setting category Operation category	Instrument type Code type	Instrument type Mode type	Instrument type Time type	Instrument type Time type

Event type	95	96	97	98
Meaning	Program time	PV1-PV2 differential upper limit during CH switching	PV1-PV2 differential lower limit during CH switching	PV1-PV2 differential upper limit
Message	PROG TIME	CHG. P-CH-DEV-H	CHG. P-CH-DEV-L	CH-DEV-H
Range of auxiliary setting 1 Message	On Time 0:00 to 500:00 ^{*3} on-time	Unused	Unused	Hysteresis 0 to 1000 SPU hysteresis
Range of auxiliary setting 2 Message	Off Time 0:00 to 500:00 ^{*3} off-time	Operating point -19999 to +20000 SPU set point	Operating point -19999 to +20000 SPU set point	Operating point -19999 to +20000 SPU set point
Setting category Operation category	Instrument type Time type	Instrument type PV type	Instrument type PV type	Instrument type PV type

*1: The meaning of auxiliary setting 1 for special segment is shown below.

- 2: Two segments before the final segment 1: First segment
- 1: One segment before the final segment 2: Second segment
- 0: Final segment

*2: When auxiliary setting 1 of RAMP-E time monitoring is set to 0.0 sec, event output is off.

*3: Auxiliary setting 1 and auxiliary setting 2 of segment time and program time that determine display unit and range of segment are set by setup data C62 settings as follows.

When C62 is set to 0: 0 hours 00 min to 500 hours 00 min

When C62 is set to 1: 0 min 00 sec to 500 min 00 sec

When C62 is set to 2: 0.0 sec to 3000.0 sec

Event type	99	100 to 127	128	129
Meaning	PV1-PV2 differential lower limit	Event off	RUN, HOLD, END, FAST	HOLD
Message	CH-DEV-L	OFF	RUN,HOLD, END, FAST	HOLD
Range of auxiliary setting 1 Message	Hysteresis 0 to 1000 SPU hysteresis	Unused	Unused	Unused
Range of auxiliary setting 2 Message	Operating point -19999 to +20000 SPU set point	Unused	Unused	Unused
Setting category Operation category	Instrument type PV type	— —	Instrument type Mode type	Instrument type Mode type

Event type	130	131	132	133
Meaning Message	READY, READY FAST READY, READY FAST	END END	G.SOAK wait G.SOAK	MANUAL MANUAL
Range of auxiliary setting 1	Unused	Unused	Unused	Unused
Range of auxiliary setting 2 Message	Unused	Unused	Unused	Unused
Setting category Operation category	Instrument type Mode type	Instrument type Mode type	Instrument type Mode type	Instrument type Mode type

Event type	134	135	136	137
Meaning Message	AT executing AT	FAST, READY FAST FAST, READY FAST	Console settings are being made CONSOLE	RUN RUN
Range of auxiliary setting 1	Unused	Unused	Unused	Unused
Range of auxiliary setting 2 Message	Unused	Unused	Unused	Unused
Setting category Operation category	Instrument type Mode type	Instrument type Mode type	Instrument type Mode type	Instrument type Mode type

Event type	138	139	140	141
Meaning Message	Advance ADV	All alarm (logical OR) ALL ALARMS	PV range alarm PV ALARMS	DCP551 alarm DCP ALARMS
Range of auxiliary setting 1	Unused	Unused	Unused	Unused
Range of auxiliary setting 2 Message	Unused	Unused	Unused	Unused
Setting category Operation category	Instrument type Mode type	Instrument type Mode type	Instrument type Mode type	Instrument type Mode type

Event type	142	143	144	145 to 253
Meaning Message	PV1 selected SELECT PV1	PV2 selected SELECT PV2	Battery voltage drop BATTERY LOW	Event off OFF
Range of auxiliary setting 1	Unused	Unused	Unused	Unused
Range of auxiliary setting 2 Message	Unused	Unused	Unused	Unused
Setting category Operation category	Instrument type Mode type	Instrument type Mode type	Instrument type Mode type	— —

■ PID parameter setting

No.	Item code	Item	Factory default settings	User settings	Settings and descriptions
1	<i>P-1</i>	Proportional band (PID group 1)	100.0		<p><i>P</i> : 0.0 to 1000.0% ON-OFF control when set to 0.0</p> <p><i>I</i> : 0 to 3600sec No integral operation when set to 0</p> <p><i>d</i> : 0 to 1200sec No derivative operation when set to 0</p> <p><i>rE</i> : 0.0 to 100.0%</p> <p><i>oL</i> : -5.0 to manipulated variable upper limit %</p> <p><i>oH</i> : Manipulated variable lower limit to +105.0%</p> <p><i>CP</i> : -19999 to +20000 SPU</p> <p><i>tP</i> : -19999 to +20000 SPU</p> <p>[Description:]</p> <ul style="list-style-type: none"> When <i>P</i> is set to 0.0, ON-OFF control is on and <i>I</i>, <i>d</i> and <i>rE</i> settings display ----- and setting cannot be performed. When the <i>I</i> setting is not equal to 0, ----- is displayed for <i>rE</i> and setting cannot be performed. Although a low <i>P</i> setting improves control, overshoot and hunting is more likely to occur. Although a low <i>I</i> setting improves tracking, cycling caused by integral operation occurs more often. Although a low <i>d</i> setting makes it easier to suppress overshoot, hunting is more likely to occur due to reactions to minute PV action. In normal temperature control, derivative time should be between 1/3 to 1/4 of the integral time. Since derivative operation is a cause of hunting in pressure and flow control, set <i>d</i> to 0.0 to turn off derivative action or set a low value. The <i>rE</i> setting is used to eliminate offset caused by proportional action (no integral action) and sets a suitable deviation of 0. The <i>oL</i> and <i>oH</i> settings also operate as integral limiters. When <i>oL</i> or <i>oH</i> manipulated variable reaches the upper or lower limit, they turn off integral action and prevents reset windup that occurs when PV has not risen for a long time. The <i>CP</i> setting is the point where switching occurs between PID groups A1 to A7. <i>tP</i> is the tuning point where <i>P</i>, <i>I</i> and <i>D</i> settings in groups A1 to A7 are automatically tuned starting from A1.
2	<i>I-1</i>	Integral time (PID group 1)	0		
3	<i>d-1</i>	Derivative time (PID group 1)	0		
4	<i>rE-1</i>	Manual reset (PID group 1)	50.0		
5	<i>oL-1</i>	Manipulated variable lower limit (Output limiter group 1)	0.0		
6	<i>oH-1</i>	Manipulated variable upper limit (Output limiter group 1)	100.0		
7	<i>P-2</i>	Proportional band (PID group 2)	100.0		
8	<i>I-2</i>	Integral time (PID group 2)	0		
9	<i>d-2</i>	Derivative time (PID group 2)	0		
10	<i>rE-2</i>	Manual reset (PID group 2)	50.0		
11	<i>oL-2</i>	Manipulated variable lower limit (Output limiter group 2)	0.0		
12	<i>oH-2</i>	Manipulated variable upper limit (Output limiter group 2)	100.0		
13	<i>P-3</i>	Proportional band (PID group 3)	100.0		
14	<i>I-3</i>	Integral time (PID group 3)	0		
15	<i>d-3</i>	Derivative time (PID group 3)	0		
16	<i>rE-3</i>	Manual reset (PID group 3)	50.0		
17	<i>oL-3</i>	Manipulated variable lower limit (Output limiter group 3)	0.0		
18	<i>oH-3</i>	Manipulated variable upper limit (Output limiter group 3)	100.0		
19	<i>P-4</i>	Proportional band (PID group 4)	100.0		
20	<i>I-4</i>	Integral time (PID group 4)	0		
21	<i>d-4</i>	Derivative time (PID group 4)	0		
22	<i>rE-4</i>	Manual reset (PID group 4)	50.0		
23	<i>oL-4</i>	Manipulated variable lower limit (Output limiter group 4)	0.0		
24	<i>oH-4</i>	Manipulated variable upper limit (Output limiter group 4)	100.0		
25	<i>P-5</i>	Proportional band (PID group 5)	100.0		
26	<i>I-5</i>	Integral time (PID group 5)	0		
27	<i>d-5</i>	Derivative time (PID group 5)	0		
28	<i>rE-5</i>	Manual reset (PID group 5)	50.0		
29	<i>oL-5</i>	Manipulated variable lower limit (Output limiter group 5)	0.0		
30	<i>oH-5</i>	Manipulated variable upper limit (Output limiter group 5)	100.0		
31	<i>P-6</i>	Proportional band (PID group 6)	100.0		
32	<i>I-6</i>	Integral time (PID group 6)	0		
33	<i>d-6</i>	Derivative time (PID group 6)	0		

No.	Item code	Item	Factory default settings	User settings	Settings and descriptions
34	<i>rE-6</i>	Manual reset (PID group 6)	50.0		
35	<i>oL-6</i>	Manipulated variable lower limit (Output limiter group 6)	0.0		
36	<i>oH-6</i>	Manipulated variable upper limit (Output limiter group 6)	100.0		
37	<i>P-7</i>	Proportional band (PID group 7)	100.0		
38	<i>I-7</i>	Integral time (PID group 7)	0		
39	<i>d-7</i>	Derivative time (PID group 7)	0		
40	<i>rE-7</i>	Manual reset (PID group 7)	50.0		
41	<i>oL-7</i>	Manipulated variable lower limit (Output limiter group 7)	0.0		
42	<i>oH-7</i>	Manipulated variable upper limit (Output limiter group 7)	100.0		
43	<i>P-8</i>	Proportional band (PID group 8)	100.0		
44	<i>I-8</i>	Integral time (PID group 8)	0		
45	<i>d-8</i>	Derivative time (PID group 8)	0		
46	<i>rE-8</i>	Manual reset (PID group 8)	50.0		
47	<i>oL-8</i>	Manipulated variable lower limit (Output limiter group 8)	0.0		
48	<i>oH-8</i>	Manipulated variable upper limit (Output limiter group 8)	100.0		
49	<i>P-9</i>	Proportional band (PID group 9)	100.0		
50	<i>I-9</i>	Integral time (PID group 9)	0		
51	<i>d-9</i>	Derivative time (PID group 9)	0		
52	<i>rE-9</i>	Manual reset (PID group 9)	50.0		
53	<i>oL-9</i>	Manipulated variable lower limit (Output limiter group 9)	0.0		
54	<i>oH-9</i>	Manipulated variable upper limit (Output limiter group 9)	100.0		
55	<i>P-A1</i>	Proportional band (PID group A1)	100.0		
56	<i>I-A1</i>	Integral time (PID group A1)	0		
57	<i>d-A1</i>	Derivative time (PID group A1)	0		
58	<i>rE-A1</i>	Manual reset (PID group A1)	50.0		
59	<i>CP-A1</i>	Changeover point (PID group A1)	1000 SPU		
60	<i>tP-A1</i>	Tuning point (PID group A1)	500 SPU		
61	<i>P-A2</i>	Proportional band (PID group A2)	100.0		
62	<i>I-A2</i>	Integral time (PID group A2)	0		
63	<i>d-A2</i>	Derivative time (PID group A2)	0		
64	<i>rE-A2</i>	Manual reset (PID group A2)	50.0		
65	<i>CP-A2</i>	Changeover point (PID group A2)	2000 SPU		
66	<i>tP-A2</i>	Tuning point (PID group A2)	1500 SPU		
67	<i>P-A3</i>	Proportional band (PID group A3)	100.0		
68	<i>I-A3</i>	Integral time (PID group A3)	0		
69	<i>d-A3</i>	Derivative time (PID group A3)	0		
70	<i>rE-A3</i>	Manual reset (PID group A3)	50.0		
71	<i>CP-A3</i>	Changeover point (PID group A3)	3000 SPU		
72	<i>tP-A3</i>	Tuning point (PID group A3)	2500 SPU		
73	<i>P-A4</i>	Proportional band (PID group A4)	100.0		
74	<i>I-A4</i>	Integral time (PID group A4)	0		
75	<i>d-A4</i>	Derivative time (PID group A4)	0		
76	<i>rE-A4</i>	Manual reset (PID group A4)	50.0		
77	<i>CP-A4</i>	Changeover point (PID group A4)	4000 SPU		
78	<i>tP-A4</i>	Tuning point (PID group A4)	3500 SPU		
79	<i>P-A5</i>	Proportional band (PID group A5)	100.0		
80	<i>I-A5</i>	Integral time (PID group A5)	0		

Chapter 7. PARAMETER SETUP

No.	Item code	Item	Factory default settings	User settings	Settings and descriptions
81	<i>d-A5</i>	Derivative time (PID group A5)	0		
82	<i>rE-A5</i>	Manual reset (PID group A5)	50.0		
83	<i>CP-A5</i>	Changeover point (PID group A5)	5000 SPU		
84	<i>tP-A5</i>	Tuning point (PID group A5)	4500 SPU		
85	<i>P-A6</i>	Proportional band (PID group A6)	100.0		
86	<i>I-A6</i>	Integral time (PID group A6)	0		
87	<i>d-A6</i>	Derivative time (PID group A6)	0		
88	<i>rE-A6</i>	Manual reset (PID group A6)	50.0		
89	<i>CP-A6</i>	Changeover point (PID group A6)	6000 SPU		
90	<i>tP-A6</i>	Tuning point (PID group A6)	5500 SPU		
91	<i>P-A7</i>	Proportional band (PID group A7)	100.0		
92	<i>I-A7</i>	Integral time (PID group A7)	0		
93	<i>d-A7</i>	Derivative time (PID group A7)	0		
94	<i>rE-A7</i>	Manual reset (PID group A7)	50.0		
95	<i>CP-A7</i>	Changeover point (PID group A7)	20000 SPU (fixed)		
96	<i>tP-A7</i>	Tuning point (PID group A7)	6500 SPU		

■ Setup data setting

No.	Item code	Item	Factory default settings	User settings	Settings and descriptions
1	C 01	PV1 range number	0		0 to 16 : T/C 48 to 52 : linear (DC current, DC voltage) 64 to 71 : RTD 96 to 103 : RTD 128 to 134: linear (DC current, DC voltage) [Description:] For details see range numbers listed in Section 2-3 Input Type and Range Number (page 2-8)
2	C 02	PV1 temperature unit	0		0: °C Celsius 1: °F Fahrenheit [Description:] When setting C01 is linear, ----- is displayed and setting cannot be performed.
3	C 03	PV1 decimal point position	1		0 to 2 A setting of 0 means no decimal point and a setting of 1 and 2 indicates the number of decimal digits. [Description:] When setting C01 is linear, ----- is displayed and setting cannot be performed. The setting range varies with the C01 and C02 setting. • A setting between 0 and 2 can be made when C01 is set to: 5, 15, 65 to 69, 97 to 101 and C02 is set to 0. C01 settings: 66, 68, 69, 98, 100, 101 and C02 is set to 1. • A setting of 0 and 1 can be made when C01 is set to: 0 to 4, 6 to 14, 16, 64, 70, 71, 96, 102, 103 and C02 is set to 0. C01 settings: 0 to 5, 7, 8, 10, 12 to 14, 16, 64, 65, 67, 70, 71, 96, 97, 99, 102, 103 and C02 is set to 1. • Only a setting of 0 is possible when C01 is set to: 6, 9, 11 and C02 is set to 1 When the C01 setting is for a t/c or RTD, this setting is reflected in PVU (PV1) units.
4	C 04	PV1 linear decimal point position	1		0 to 4 A setting of 0 means no decimal point and a setting between 1 and 4 indicates the number of decimal digits. [Description:] C01 settings for t/c and RTD display ----- and setting cannot be performed. When setting C01 is linear, this setting is reflected in PVU (PV1) units.
5	C 05	PV1 linear range lower limit	0 PVU		-19999 to +20000 PVU (PV1) [Description:] C01 settings for t/c and RTD display ----- and setting cannot be performed.
6	C 06	PV1 linear range upper limit	10000PVU		Reversing the lower limit and upper limit makes it possible to reverse analog inputs and specified values.
7	C 07	PV1 cold junction compensation	0		0: Provided (compensated internally) 1: Not provided (compensated externally) [Description:] C01 settings for T/C and RTD display ----- and setting cannot be performed.
8	C 08	PV1 square root extraction	0		0: Not provided 1: Provided [Description:] C01 settings for t/c and RTD display ----- and setting cannot be performed.
9	C 09	PV1 square root extraction dropout	0.2		0.2 to 10.0% (ratio depends on input range) [Description:] C01 settings for T/C and RTD display ----- and setting cannot be performed.
10	C 10	PV1 cold junction bias	0.0		-1.0 to +1.0 °C [Description:] C01 settings for t/c and RTD display ----- and setting cannot be performed. Use 0.0 for normal settings.

No.	Item code	Item	Factory default settings	User settings	Settings and descriptions
11	C 11	PV2 range number	0		0 to 16 : T/C 48 to 52 : linear (DC current, DC voltage) 64 to 71 : RTD 96 to 103 : RTD 128 to 134: linear (DC current, DC voltage) [Description:] For details see range numbers listed in "Section 2-3 Input Type and Range Number" (page 2-8).
12	C 12	PV2 temperature unit	0		0: °C Celsius 1: °F Fahrenheit [Description:] When setting C11 is linear, "-----" is displayed and setting cannot be performed.
13	C 13	PV2 decimal point position	1		0 to 2 A setting of 0 means no decimal point and a setting of 1 and 2 indicates the number of decimal digits. [Description:] When setting C11 is linear, "-----" is displayed and setting cannot be performed. The setting range varies with the C11 and C12 setting. • A setting between 0 and 2 can be made when C11 is set to: 5, 15, 65 to 69, 97 to 101 and C12 is set to 0. C11 settings: 66, 68, 69, 98, 100, 101 and C12 is set to 1. • A setting of 0 and 1 can be made when C11 is set to: 0 to 5, 7, 8, 10, 12 to 14, 16, 64, 65, 67, 70, 71, 96, 97, 102, 103 and C12 is set to 1. • Only a setting of 0 is possible when C11 is set to: 6, 9, 11 and C12 is set to 1. • When the C11 setting is for T/C or RTD, this setting is reflected in PVU (PV2) units.
14	C 14	PV2 linear decimal point position	1		0 to 4 A setting of 0 means no decimal point and a setting between 1 and 4 indicates the number of decimal digits. [Description:] C11 settings for T/C and RTD display "-----" and setting cannot be performed. When setting C11 is linear, this setting is reflected in PVU (PV2) units.
15	C 15	PV2 linear range lower limit	0 PVU		-19999 to +20000 PVU (PV2) [Description:] C11 settings for T/C and RTD display "-----" and setting cannot be performed.
16	C 16	PV2 linear range upper limit	10000PVU		Reversing the lower limit and upper limit makes it possible to reverse analog inputs and specified values.
17	C 17	PV2 cold junction compensation	0		0: Yes (compensated internally) 1: No (compensated externally) [Description:] C11 settings for T/C and RTD display "-----" and setting cannot be performed.
18	C 18	PV2 square root extraction	0		0: No 1: Yes [Description:] C11 settings for T/C and RTD display "-----" and setting cannot be performed.
19	C 19	PV2 square root extraction dropout	0.2		0.2 to 10.0 % (ratio depends on input range) [Description:] C11 settings for T/C and RTD display "-----" and setting cannot be performed.
20	C 20	PV2 cold junction bias	0.0		-1.0 to +1.0 °C [Description:] C11 settings for T/C and RTD display "-----" and setting cannot be performed. Use 0.0 for normal settings.

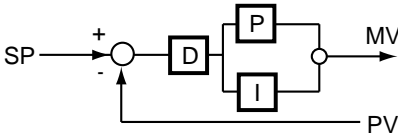
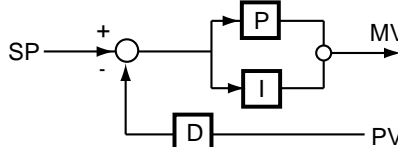
No.	Item code	Item	Factory default settings	User settings	Settings and descriptions
21	C 21	Control output system	1		<p>0 : 5S output (current proportional SP output) 1 : 5G output (current proportional control output) 2 : 6D output (voltage time proportional control output) system A 3 : 6D output (voltage time proportional control output) system B 4 : 8D output (open collector time proportional control output) system A 5 : 8D output (open collector time proportional control output) system B [Description:] The difference between system A and system B is in the output system of ON-OFF control and auto-tuning. System A: Output ON-OFF is performed regardless of time proportional output cycles and output limits. System B: The output limit upper limit value is output instead of on and the output limit lower value is output instead of off according to time proportional output cycles.</p>
22	C 22	Unused	----		<p>[Description:] ----- is displayed and setting cannot be performed.</p>
23	C 23	Control operation	0		<p>0: PID-A reverse operation 1: PID-A normal operation 2: PID-B reverse operation 3: PID-B normal operation [Description:] PID-A: deviation derivative PID (system where SP changes are affected by derivative action)</p>  <p>PID-B: derivative-based PID (system where SP changes are not affected by derivative action)</p> 
24	C 24	Unused	----		
25	C 25	PV channel switching type	0		<p>0: PV1 low-temperature sensor, PV2 high-temperature sensor 1: PV1 high-temperature sensor, PV2 low-temperature sensor 2: PV1 tied 3: PV2 tied 4: Backup switching [Description:] ----- is displayed and setting cannot be performed on model with one PV input channel.</p>
26	C 26	PV channel switching system	0		<p>0: External switch switching 1: Automatic switching A (switching + dead band) 2: Automatic switching B (switching + dead band + external switch) 3: Automatic switching C (2-point proportional) [Description:] ----- is displayed and setting cannot be performed on model with one PV input channel. When C25 is set to more than 1, [----] is displayed and setting cannot be performed.</p>
27	C 27	PV channel switching point	10000PVU		<p>—19999 to +20000 PVU (PV1) [Description:] ----- is displayed and setting cannot be performed on model with one PV input channel. When C25 is set to more than 1, [----] is displayed and setting cannot be performed. When C26 is set 0, [----] is displayed and setting cannot be performed.</p>

Chapter 7. PARAMETER SETUP

No.	Item code	Item	Factory default settings	User settings	Settings and descriptions
28	C 28	PV channel switching dead band	100 PVU		1 to 1000 PVU (PV1) [Description:] ----- is displayed and setting cannot be performed on model with one PV input channel. When C25 is set to more than 1, ----- is displayed and setting cannot be performed. When C26 is set 0, ----- is displayed and setting cannot be performed.
29	C 29	Selections available when power is on during PV channel switching	0		0: Continues until power is turned off 1: PV1 2: PV2 3: High-temperature PV 4: Low-temperature PV [Description:] ----- is displayed and setting cannot be performed on model with one PV input channel. When C25 is set to more than 1, ----- is displayed and setting cannot be performed. When C26 is set 0, ----- is displayed and setting cannot be performed.
30	C 30	PV equalizer	0		0: No 1: PV1 only 2: PV2 only 3: PV1 and PV2 [Description:] The range of settings is 0 to 1 on model with one PV input channel.
31	C 31	End of operation	0		0: READY mode 1: END mode
32	C 32	Manipulated variable in READY mode	0.0		-5.0 to +105.0 %
33	C 33	Manipulated variable setting in PV overrange	0		0: No 1: Yes
34	C 34	Manipulated variable in PV overrange	0.0		-5.0 to +105.0 %
35	C 35	Manual change mode	0		0: smooth 1: preset [Description:] When C21 is set to 0, the output is smooth regardless of setting.
36	C 36	Preset MANUAL value	0.0		—5.0 to +105.0 %
37	C 37	Unused	----		[Description:] ----- is displayed and setting cannot be performed.
38	C 38	Unused	----		
39	C 39	Unused	----		
40	C 40	Unused	----		
41	C 41	Unused	----		
42	C 42	Unused	----		
43	C 43	Length of outage permitting continuous operation	0		0 to 3600sec When set to 0, operation continues regardless of outage time. [Description:] The HOLD mode is invoked when the outage is longer than set time. The measurement of a power outage may vary by about 10 seconds.
44	C 44	Unused	----		[Description:] ----- is displayed and setting cannot be performed.
45	C 45	Auxiliary output 1 type	0		0: SP 1: PV 2: Deviation (DEV) 3: Manipulated variable (MV) 4: PV1 5: PV2 [Description:] ----- is displayed and setting cannot be performed on model without auxiliary output.
46	C 46	Auxiliary output 1 lower limit (4mA)	0 SPU		-19999 to +20000 SPU (C45 not equal to 3) -1999.9 to +2000.0 SPU (C45 set to 3)
47	C 47	Auxiliary output 1 upper limit (20mA)	10000SPU		[Description:] ----- is displayed and setting cannot be performed on model without auxiliary output.

No.	Item code	Item	Factory default settings	User settings	Settings and descriptions
48	C 48	Auxiliary output 2 type	0		0: SP 1: PV 2: Deviation (DEV) 3: Manipulated variable (MV) 4: PV1 5: PV2 [Description:] ----- is displayed and setting cannot be performed on model without auxiliary output or with one auxiliary output.
49	C 49	Auxiliary output lower limit (4mA)	0 SPU		-19999 to +20000 SPU (C48 not equal to 3) -1999.9 to +2000.0% (C48 set to 3) [Description:] ----- is displayed and setting cannot be performed on model without auxiliary output or with one auxiliary output.
50	C 50	Auxiliary output upper limit (20mA)	10000SPU		[Description:] ----- is displayed and setting cannot be performed.
51	C 51	Unused	----		[Description:] ----- is displayed and setting cannot be performed.
52	C 52	SP output lower limit (4mA)	0 SPU		-19999 to +20000 SPU [Description:] ----- is displayed and setting cannot be performed when C21 is not equal to 0.
53	C 53	SP output upper limit (20mA)	10000SPU		[Description:] ----- is displayed and setting cannot be performed.
54	C 54	Unused	----		[Description:] ----- is displayed and setting cannot be performed.
55	C 55	Unused	----		
56	C 56	Unused	----		
57	C 57	Programming item event	0		0: Displayed 1: Not displayed
58	C 58	Programming item PID group, output limiter group	0		0: Displayed 1: Not displayed
59	C 59	Programming item G.SOAK, PV shift, repeat	0		0: Displayed 1: Not displayed
60	C 60	Programming item PV start, cycle, pattern link	0		0: Displayed 1: Not displayed
61	C 61	Programming system	0		0: RAMP-X and RAMP-T (θ)° combined 1: RAMP-X and RAMP-E (~SP) combined
62	C 62	Programming time unit	0		0: hours, min (SPU/hour for RAMP-T) 0: min, sec (SPU/min for RAMP-T) 0: 0.1 sec (SPU/sec for RAMP-T)
63	C 63	Time display (display panel 2)	0		0: remaining segment time 1: total operation time (after READY → RUN start)
64	C 64	Unused	----		[Description:] ----- is displayed and setting cannot be performed.
65	C 65	SP decimal point position	1		0 to 4 A setting of 0 means no decimal point and a setting between 1 and 4 indicates the number of decimal digits. [Description:] This setting is reflected in PVU (SPU) units.
66	C 66	SP limit lower limit	PV1 range lower limit		-19999 to +20000 SPU [Description:] When C01 to C06 are set, C66 and C67 are automatically set as the upper limit and lower limit of the range.
67	C 67	SP limit upper limit	PV1 range upper limit		[Description:] ----- is displayed and setting cannot be performed.
68	C 68	Unused	----		
69	C 69	Unused	----		
70	C 70	Unused	----		

Chapter 7. PARAMETER SETUP

No.	Item code	Item	Factory default settings	User settings	Settings and descriptions
71	C 71	External switch input RSW5	0		0 : NOP (does not function) 1 : RAMP-E 2 : FAST 3 : G.SOAK is cleared using OR 4 : G.SOAK is cleared using AND 5 : AUTO/MANUAL 6 : AT 7 : PV1/PV2 8 : Auto load 9 : PV1 → PV2 wait 10: PV2 → PV1 wait 11: NOP (does not function) 12: Normal operation/reverse operation
72	C 72	External switch input RSW6	0		
73	C 73	External switch input RSW7	0		
74	C 74	External switch input RSW8	0		
75	C 75	External switch input RSW9 to 16 (program selection)	0		0: BCD4 bit x 2 digits 1: binary 7 bits
76	C 76	Communication address	0		0 to 127 [Description:] ----- is displayed and setting cannot be performed on model without communications. When C76 is set to 0, the communication function is not activated.
77	C 77	Transmission rate	0		0: 9600bps 1: 4800bps 2: 2400bps 3: 1200bps [Description:] ----- is displayed and setting cannot be performed on model without communications.
78	C 78	Transmission code	0		0: 8 bits, even parity, 1 stop bit 1: 8 bits, no parity, 2 stop bits [Description:] ----- is displayed and setting cannot be performed on model without communications.
79	C 79	Communication	0		0: CPL 1: ST221 (no PV trend) 2: ST221 (PV trend) [Description:] ----- is displayed and setting cannot be performed on model without communications.
80	C 80	Communication method	0		0 : RS-485 1 : RS-232C [Description:] ----- is displayed and setting cannot be performed on model without communications.
81	C 81	ROM ID	—		[Description:]
82	C 82	ROM ITEM	—		Can only be referenced for mechanical service use.
83	C 83	ROM revision	—		
84	C 84	Data version	—		
85	C 85	CPU board ID	—		
86	C 86	I/O board ID	—		
87	C 87	Unused	----		[Description:] ----- is displayed and setting cannot be performed.
88	C 88	Unused	----		
89	C 89	Unused	----		
90	C 90	PID type	1		0: Improved 1: Compatible with Mark I
91	C 91	PV1 burnout	0		0: Yes 1: No
92	C 92	PV2 burn out	0		0: Yes 1: No [Description:] ----- is displayed and setting cannot be performed on model with one PV input channel.
93	C 93	Time proportional output system	0		0: Does not go on a second time off in time proportional cycle. 1: Goes on a second time in time proportional cycle.

No.	Item code	Item	Factory default settings	User settings	Settings and descriptions
94	<i>C 94</i>	Unused	----		[Description:] ----- is displayed and setting cannot be performed.
95	<i>C 95</i>	Voltage output control	15		2 to 22mA
96	<i>C 96</i>	Unused	----		[Description:] ----- is displayed and setting cannot be performed.
97	<i>C 97</i>	Communications port	0		0 to 15 The backplate terminal is used when set to 0. The loader jack is used for settings 1 to 15. [Description:] When set to 0, communications cannot be performed on model without communications. When set to 0, communications conditions are selected using <i>C76</i> to <i>C80</i> . The communication address is used for settings 1 to 15. 4800bps, 8 bits, even parity, 1 stop bit
98	<i>C 98</i>	Special function	0		0 to 255 [Description:] A setting of 0 is normally used.
99	<i>C 99</i>	PV1 zener barrier adjustment	----		-20.00 to +20.00 [Description:] ----- is displayed and setting cannot be performed when PV1 is not RTD or <i>C98</i> is not equal to 241.
100	<i>C100</i>	PV2 zener barrier adjustment	----		-20.00 to +20.00 [Description:] ----- is displayed and setting cannot be performed when PV2 is not RTD or <i>C98</i> is not equal to 241.

■ Detailed descriptions of setup data settings

● C07 (PV1 cold junction compensation)

● C17 (PV2 cold junction compensation)

- This is a selection for cold junction compensation for thermocouples.
- When set to 1, perform 0°C compensation using a cold junction compensation device outside the DCP551

● C08 (PV1 square root extraction)

● C09 (PV1 square root extraction dropout)

● C18 (PV2 square root extraction)

● C19 (PV2 square root extraction dropout)

- Flow pressure detected by the orifice of a normal differential pressure type flowmeter is proportional to the power 2 of the flow rate signal. Consequently, square root extraction is used when a uniform signal is needed. When the input in the square root extraction is C09 or less than the dropout set in C19, an output of 0% can be obtained in the square root process.
- Square root extraction is not performed when C08 and C18 are set to 0.

Output of root extraction (Y)

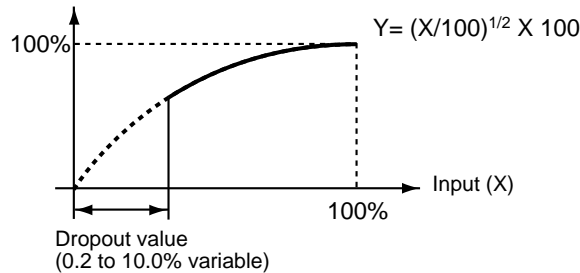

● C46 (auxiliary output 1 lower limit)

● C47 (auxiliary output 1 upper limit)

● C49 (auxiliary output 2 lower limit)

● C50 (auxiliary output 2 upper limit)

- This is the scaling setting of the auxiliary output. The high and low values for the upper and lower limits can be reversed.
- The example below shows that the output from auxiliary output 1 is 12mA when MV is 100% and 20mA when MV is 0%. As shown, a 200% MV value is required to generate an output of 4mA. Thus C46 is set to 200.0 and C47 is set to 0.0.

Auxiliary output 1

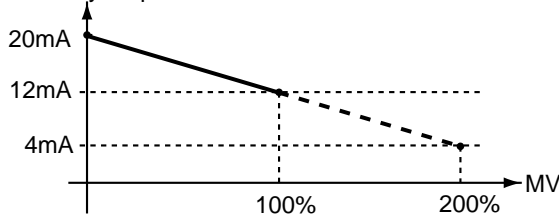

- **C52 (SP output lower limit)**

- **C53 (SP output upper limit)**

These are scaling settings of SP output. The high and low values for the upper and lower limits can be reversed.

- **C63 (time display)**

0: remaining segment time

1: total operation time

- These are selections for display panel 2 in the normal display mode in the program run mode.
- In the READY mode a setting of 0 displays the set time values for the selected segments.
- In the RUN, HOLD, FAST and END modes a setting of 0 displays the remaining time in rounded hours.
For example, when the time unit hours/min is selected a remaining time of 1 hour 30 minutes and 59 seconds is displayed as “1.30”.
- In the READY mode a setting of 1 displays the time as “0.00”.
- In the RUN, HOLD, FAST and END modes a setting of 1 means that the time is displayed in rounded hours after a change from the READY mode to the RUN mode. In G.SOAK wait, repeat, cycle and pattern link, time is displayed as integrated values.
When the time unit is hours/min or min/sec, the display returns to “0.00” after “499.59”. When the time unit is 0.1 sec, the display returns to “0.0” after “2999.9”.
When the time unit is hour/min, a total operating time of 501 hours 30 minutes and 59 seconds is displayed as “1.30”.
- In FAST mode a setting of 0 or 1 displays the time according to FAST X.

- **C66 (SP limit lower limit)**

- **C67 (SP limit upper limit)**

- These settings operate as limiters when SP is set or changed in the program setting pattern items.
- In the program run mode these settings operate as limiters when SP and SP bias (variable parameter) set in a program are added to produce the resulting SP.
- These settings operate as limiters when SP is set or changed in constant value control data settings.
- In the constant value control mode these settings operate as limiters when SP and SP bias (variable parameter) set in constant value control data settings are added to produce the resulting SP.

● **C93 (time proportional output system)**

0: Goes not on again within time proportional cycle

1: Does on again within time proportional cycle

- This setting determines whether the output is to go on again after the result of a PID computation has changed in a time proportional cycle (cycle time) and the output has been turned off.
- The difference between the two settings is illustrated below.

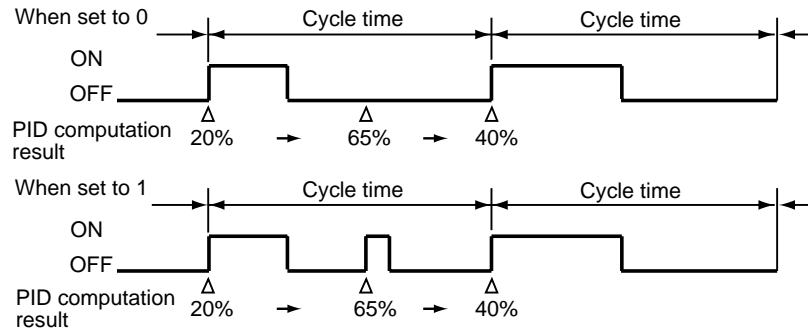

● **C95 (voltage output control)**

[Constant current type]

- Input current (maximum): Check that the input current is within the maximum allowable current or less, then the parallel connection can be made.
- Operating voltage range (input): Check that the voltage between the terminals of the voltage pulse output is within the specified range.

This example shows the calculation for the connection of this unit and the PGM10N015.

(Note: For connection with other model number, check the specifications of each model.)

- Input current(maximum): Since the input current is 10mA or less, up to two units (10mA X 2 = 20mA < 24mA [maximum allowable current]) can be connected in parallel.
- Operating voltage range (input): The rating voltage is 3.5 to 30Vdc. Therefore, terminal voltage when terminals are opened, is within the range.

Connection diagram

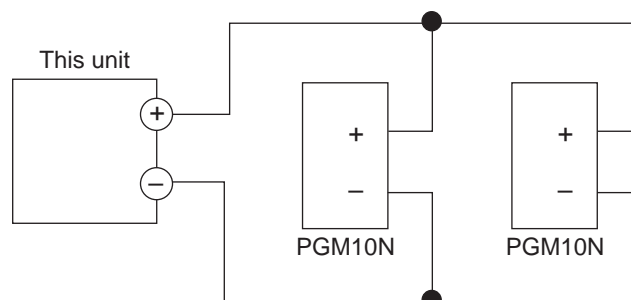

Example: Number of connectable units and settings

Settings		Model:6D(in case of C21=2 or 3)
		C95
SSR to be used	1unit	10 or more
	2units(Parallel)	20 or more
PGM10N	1unit	12 or more
PGM10F	1unit	12 or more

[Resistor type]

In a voltage time proportional output driven by SSR, the **DCP551** must enter the SSR rated input voltage (optimum striking voltage of arc).

The **DCP551** employs a newly developed variable output system that can output optimum striking voltage of arc to accommodate multiple SSR drives. A suitable current value is set on the **DCP551** to obtain optimum striking voltage of arc for the internal impedance of the SSR. An equivalent circuit with related equations is shown below.

- Description of symbols

- (1) Settings

I_0 : set **DCP551** output current (range: 2 to 22mA)

V_0 : end-to-end load voltage (13.2V)

$V_{SSR'}$: actual voltage input to SSR

V_{SSR} : rated input voltage range for SSR ($V_{SSR/MIN}$ to $V_{SSR/MAX}$)

$V_{SSR/MIN}$: minimum SSR rated input voltage

$V_{SSR/MAX}$: maximum SSR rated input voltage

Z : internal SSR impedance

V_D : internal SSR voltage drop (normally about 1 to 2V)

- (2) Equivalent circuit showing connection of one SSR

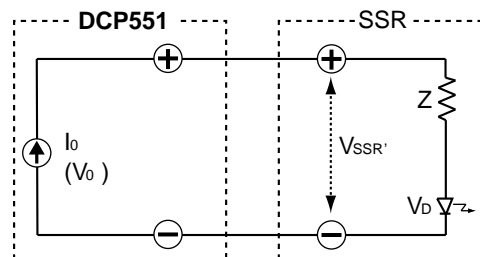

Equations (1) and (2) below must be satisfied.

$$V_{SSR/MIN} \leq I_0 \times Z + V_D \leq V_0 \quad \text{Equation (1)}$$

$$V_{SSR'} \leq V_{SSR/MAX} \quad \text{Equation (2)}$$

$$(V_{SSR'} = I_0 \times Z + V_D)$$

(3) Equivalent circuit showing connection of n SSRs

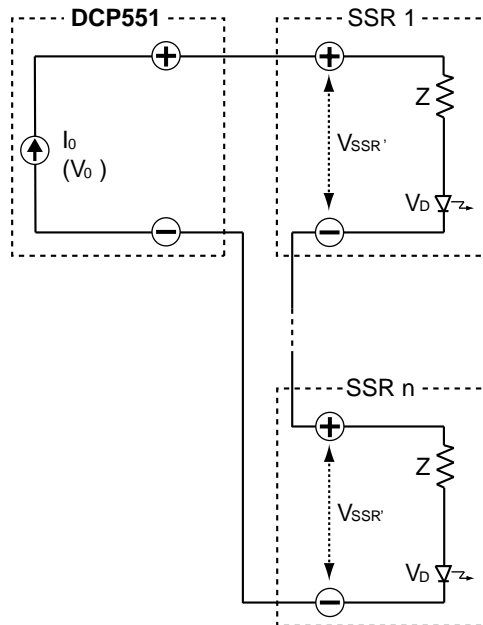

Equations (3) and (4) below must be satisfied.

$$V_{SSR/MIN} \leq I_0 \times Z + V_D \leq V_0 / N \quad \text{Equation (3)}$$

$$V_{SSR'} \leq V_{SSR/MAX} \quad \text{Equation (4)}$$

$$(V_{SSR'} = I_0 \times Z + V_D)$$

(4) Equivalent circuit showing parallel connection of n SSRs

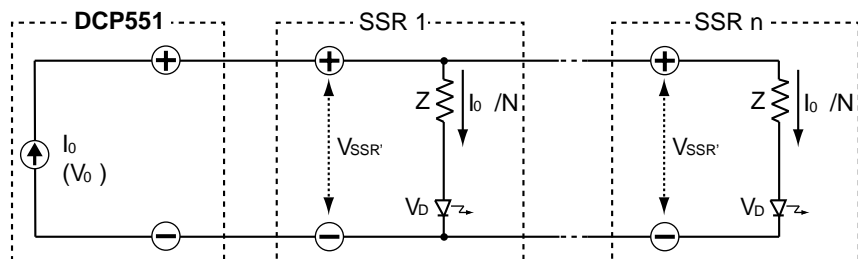

Equations (5) and (6) below must be satisfied.

$$V_{SSR/MIN} \leq I_0 / N \times Z + V_D \leq V_0 \quad \text{Equation (5)}$$

$$V_{SSR'} \leq V_{SSR/MAX} \quad \text{Equation (6)}$$

$$(V_{SSR'} = I_0 / N \times Z + V_D)$$

(5) Example showing use of Yamatake PGM

V_{SSR} : 3 to 6V
 Z : $260\Omega \pm 5\%$
 V_D : 0.8 to 1.3V

- IO required in connecting one PGM

As shown in the figure below, a constant current system is employed in the voltage output of the **DCP551**. The input voltage range of the PGM is as follows.

" $8.9\text{mA} \leq I \leq 17.2\text{mA}$ " can be established:

$$I_{MIN} \times Z_{MIN} + V_{D/MIN} > 3$$

$$I_{MIN} > 8.9\text{mA}$$

$$I_{MAX} \times Z_{MAX} + V_{D/MAX} < 6$$

$$I_{MAX} < 17.2\text{mA}$$

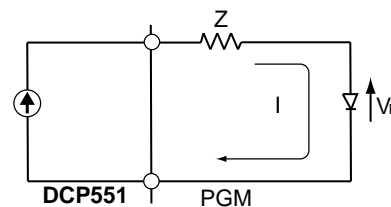

- Each PGM requires 8.9mA; the maximum output current of the **DCP551** is 22mA. Thus two PGMs can be connected in parallel.
 When connected in series, the maximum output current of the **DCP551** is 22mA, the allowable load resistance is 600Ω and the maximum voltage that can be applied to a load is 13.2V ($22\text{mA} \times 600\Omega$). When 8.9mA is applied to a PGM, the maximum voltage of the input terminals end-to-end is 3.7V.
 $0.0089 \times 260 \times 1.05 + 1.3 = 3.7\text{V}$
 Since $13.2 \div 3.7 = 3.5$, three PGMs can be connected in series.
 The calculation above is a "worst case scenario." For example, assuming that 3V or more is applied to each PGM, four PGMs should operate normally.

- **C99 (PV1 zener barrier adjustment)**
- **C100 (PV2 zener barrier adjustment)**

The adjustment described below must be performed when a zener barrier is used.

- (1) Turn off the **DCP551**. When installation and wiring is completed, short-circuit A and B on the resistance temperature detector.

¥ PV1 zener barrier adjustment

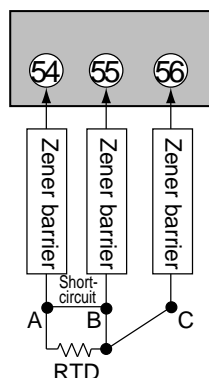

¥ PV2 zener barrier adjustment

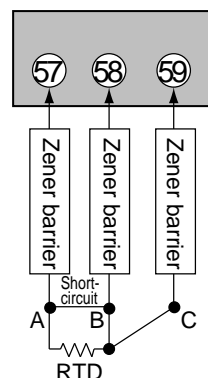

- (2) Turn on the **DCP551** and set setup data *C98* to 241.
- (3) Display setup data *C99* and *C100*.
- (4) Press the **ENTER key** to display the difference in resistance (A-B) between zener barriers connected to wire A and wire B.
- (5) Press the **ENTER key** to store the difference in resistance values (A-B) in the **DCP551**.
- (6) Press the **DISP key** to return to the normal display mode.
- (7) Turn off the **DCP551** and disconnect the wire between A and B.

! Handling Precautions

- Adjust the resistance in the zener barriers connected to wire A and B to 20Ω or less. Adjustment is not possible if the resistance is higher than 20Ω.
- This adjustment is not required for inputs other than resistance temperature detectors or when zener barriers are not to be used.
- When a zener barrier has been adjusted, compensation is performed for this zener barrier. When resistance temperature detector inputs not employing zener barriers are to be used, perform the above adjustment without the zener barriers.

■ Constant value control data setting

No.	Item code	Item	Factory default settings	User settings	Settings and descriptions
1	<i>ConSt</i>	Control mode	0		0: Program run mode 1: Constant value control mode [Description:] When setup <i>C21</i> is set to 0, this setting is automatically set to 0.
2	<i>SP</i>	Setpoint	0		Within the range of setup <i>C66</i> to <i>C67</i> (SP limit)
3	<i>P</i>	Proportional band	100.0		0.0 to 1000.0% A setting of 0.0 turns on ON-OFF control
4	<i>I</i>	Integral time	0		0 to 3600sec No integral operation when set to 0. [Description:] When <i>P</i> is set to 0.0, ----- is displayed and setting cannot be performed.
5	<i>d</i>	Derivative time	0		0 to 1200 sec No integral operation when set to 0. [Description:] When <i>P</i> is set to 0.0, ----- is displayed and setting cannot be performed.
6	<i>rE</i>	Manual reset	50.0		0.0 to 100.0% [Description:] When <i>P</i> is set to 0.0, ----- is displayed and setting cannot be performed. When <i>I</i> is not equal to 0, ----- is displayed and setting cannot be performed.
7	<i>oL</i>	Manipulated variable lower limit	0.0		-5.0% to upper limit
8	<i>oH</i>	Manipulated variable upper limit	100.0		Lower limit to +105%

Chapter 8. PROGRAM SETUP

8 - 1 Program Setup

Programming is enabled in the normal display mode. When the **DCP551** is not in the normal mode display, press the **DISP key** to invoke it. Programming is simpler if you set down the objectives of the program on a program work sheet before you start programming.

NOTE

For ease of use, please enlarge the copy of the **DCP551/552 Program Work Sheet** located after page 1 1 - 8 .

■ Selecting number of program to operate

Numbers can be selected in one of two ways.

- before programming
- during programming

● Selecting program number before programming

Press the **PROG key** in the normal display mode in the READY mode. When the program number starts flashing, use the **PROG key** or the **↑, ↓, ←, and → keys** to select a number.

Handling Precautions

Program numbers cannot be selected during external switch input. See “Section 6-3 Selecting Programs” (page 6-7) for details.

● Selecting program number during programming

Press the **FUNC** and **PROG keys** in program setting state so that the program number starts to flash. Use the **↑, ↓, ←, and → keys** to make the desired changes and press the **ENTER key** to enter them. Note, however, that you must after exiting the registration state (when set values flash) with the **ENTER key**, press the **FUNC** and **PROG keys**. When programs are selected in this way, the pattern items are displayed on the programming map.

This allows you to select a program number of a program other than the one processed in the RUN mode. It also allows you to select the number of another program using the external switches.

■ Starting programming

● Key operations

Start programming by pressing the **FUNC** and **PROG** keys in the normal display mode.

In the program setting state, PRG LED on the console lights and the decimal points in the program number display and the segment number display lights.

Note, however, that the program setting state cannot be entered in the following cases.

- In the constant value control mode (and the constant value control data *ConSt* is set to 1)
- When keylock is engaged (and variable parameters *PA01* is set to 2 or 3)

In the following condition changes cannot be made in the program setting state.

- When a program is protected (and variable parameter *PA02* is set to 1, 3 or 5)

● Start of display items

When programming is started, the number of the started program and its segment are displayed.

■ State transition

The figure below shows the transition of states during programming.

The numbered items (1) to (19) are described on the following page.

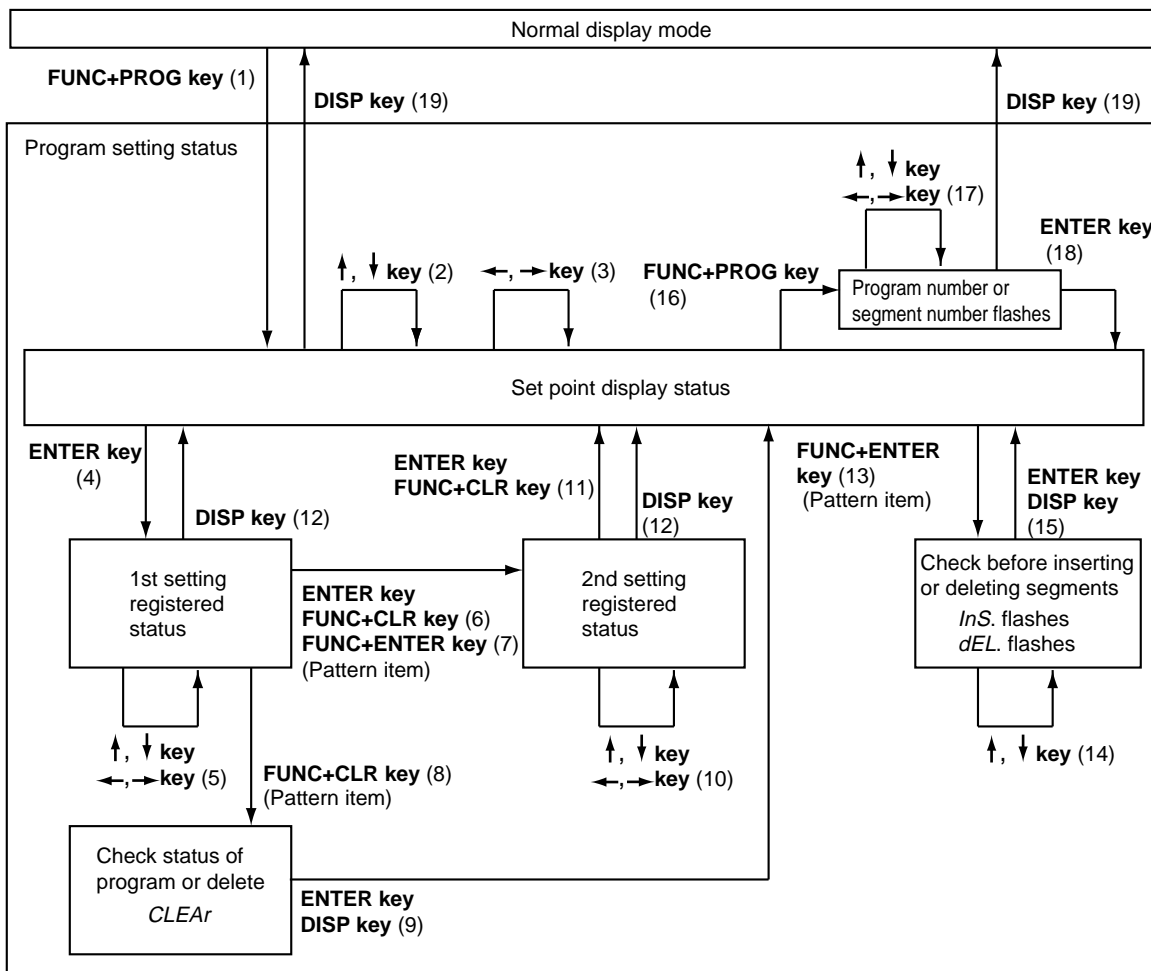

● **Description of numbered items in the figure illustrating the program setting state**

- (1) Programming is started. Up to about 1 second after the programming state is entered, the remaining number of segments is displayed in display panel 1 and the remaining number of subfunctions is displayed in display panel number 2 . The display can be held by pressing the **FUNC key**.
- (2) Move the setting items on the programming map.
- (3) Move the segments on the programming map.
- (4) Register the first setting.
- (5) Increase or decrease the values in the first setting and move the flashing digits.
- (6) Complete the registration of the first setting.
Pressing the **ENTER key** registers the set value in memory.
For items with a second setting, the registration state for the second item is displayed. The display reverts to display set values for items without a second setting. Pressing the **FUNC** and **CLR keys** returns a segment to its initial state.
- (7) Use the **FUNC** and **ENTER keys** in pattern items to go between RAMP- X \Leftrightarrow RAMP- T and RAMP- \times RAMP- E. The setting in setup data 61 determines the changeover that is actually performed.
Note, however, that a changeover cannot be made when a segment is running.
- (8) Use the **FUNC** and **CLR keys** in pattern items to display “CLEAR” to delete the program beyond that segment.
Note, however, that the **FUNC** and **CLR keys** are invalid when a program is running.
- (9) When the **ENTER keys** is used, the program beyond the point where the key was pressed is deleted. Pressing the **DISP key** does not delete any data but causes the display to show set values.
- (10) Increase or decrease the values in the second setting and move the flashing digits.
- (11) Complete the registration of the second setting.
Pressing the **ENTER keys** registers the set value in memory.
Pressing the **FUNC** and **CLR keys** returns a segment to its initial state.
- (12) Complete the registration without entering the value in memory.
- (13) Pressing the **FUNC** and **ENTER keys** in pattern items displays the segment insertion and deletion panel “InS.” flashes.
Note, however, that the **FUNC** and **ENTER keys** are invalid when a program is running.
- (14) Use the **↓ key** to delete and the **↑ key** to insert the flashing item.
- (15) Pressing the **ENTER keys** when “InS.” is displayed inserts the segment.
Pressing the **ENTER keys** when “dEL.” is displayed deletes the segment.
Pressing the **DISP key** neither deletes or inserts the segment.
- (16) Press the **FUNC** and **PROG keys** so that the program number starts to flash.
- (17) Program numbers and segment numbers can be increased or decreased and the moving digits can be moved.
- (18) Pressing the **ENTER keys** completes the registration of program and segment numbers.
- (19) The normal display mode appears.

■ Programming map

As shown below, a programming map consists of columns of segment numbers and rows of program setting items.

In the program setting state, the items in the solid lines indicated by the segment numbers and program setting items are displayed.

← key, → key : moves segments right and left

↑ key, ↓ key : moves segments up and down

The figure shows a programming map from the first to the 10th segment.

Programming map example:

Items cannot be moved to the gray area.
Settings in the gray area are shared with segment 1.

Segment number		1	2	10	11	12 to 99	Remarks
Program item	(1) No.1 setting (2) No.2 setting	1	2	10	11	12 to 99	Remarks
Pattern	(1) SP (2) Time	100 0:30	100 3:00		100 10:00	----- -----		*1
Event 1	(1) Operating point	1100	-----		-----			*2
Event 2	(1) Operating point	-----	30		-----			
Event 3	(1) On Time (2) Off Time	0:00 0:01	0:00 0:01		0:00 0:01			
Event 4	(1) On Time (2) Off Time	----- -----	0:00 1:00		----- -----			
Event 5	(1) Code	1	2		3			
Event 7-1	(1) Code (2) Time	1 0:10	--- ---		2 5:00			
Event 7-2	(1) Code (2) Time	0 0:20	--- ---		3 9:00			
PIG group, output limiter group	(1) PID group (2) Output limiter group	3 3	A 1		1 7			*3
G.SOAK	(1) Type (2) G.SOAK width	0 -----	2 5		1 10			*4
PV shift	(1) Shift value	-----	-----		-----			
Repeat	(1) Return destination segment (2) Count	0 -----	0 -----		0 -----			
PV start	(1) Type	0	0		0			
Cycle	(1) Count	0	0		0			
Pattern link	(1) Link destination program	0	0		0			
Tag	(1) 8 character tag	PROG9999	PROG9999		PROG9999			

*1 : Items up to segment 10 has been entered.

*2 : The event types of each event are listed below.

Event 1 / 2 : PV upper limit (event type setting 2)

Event 3 / 4 : time event (event type setting 1)

Event 5 : code event using two points
(event type setting 1 8, auxiliary setting 2)

Event 7 : time code event using two points
(event type setting 2 3, auxiliary setting 2)

Event 9 to 16 : event off (event type setting 0)

*3 : Use of controller function (setup data C21 is set to something other than 0)

*4 : These are settings used in each program and are shared by all segments.

■ Display items

Items displayed are shown in the figure below.

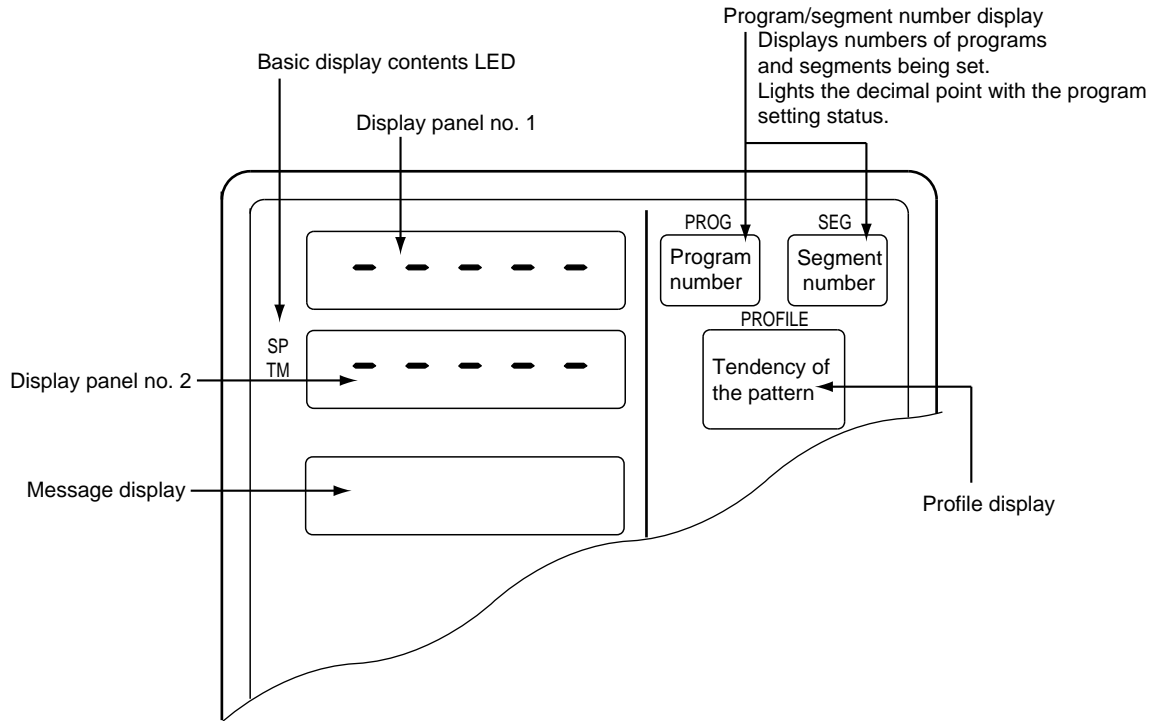

■ Setting pattern items

- (1) In the set value display state, move to the segment pattern item to be set on the programming map.
- (2) Press the **ENTER key** to make display panel 1 flash (registration of first setting) .
- (3) Use the **↑, ↓, ←, → keys** to set the first setting (SP) .
Setting range: SP limit lower limit to upper limit
(SP limit is set using setup data C66 and C67.)
- (4) Pressing the **ENTER key** stops display panel 1 from flashing and causes display panel 2 to start flashing. (This starts start registration of the second setting.) Instead of pressing the **ENTER key**, press the **FUNC** and **ENTER keys** to switch between RAMP types (selecting RAMP- X ⇔ RAMP- T, or RAMP- X ⇔ RAMP- E is made with setup data C61) .
- (5) Use the **↑, ↓, ←, → keys** to make the second setting (time) .
Setting range: 0 : 00 to 5 00 : 00, 0 . 0 to 3 000 . 0
(Time units are selected using setup data C62 to set Hour/ min, Min/ sec, 0 . 1 sec. Since a colon “ : ” cannot be displayed, the decimal point is used instead.)
- (6) Press the **ENTER key** to stop display panel 2 from flashing.

● Display

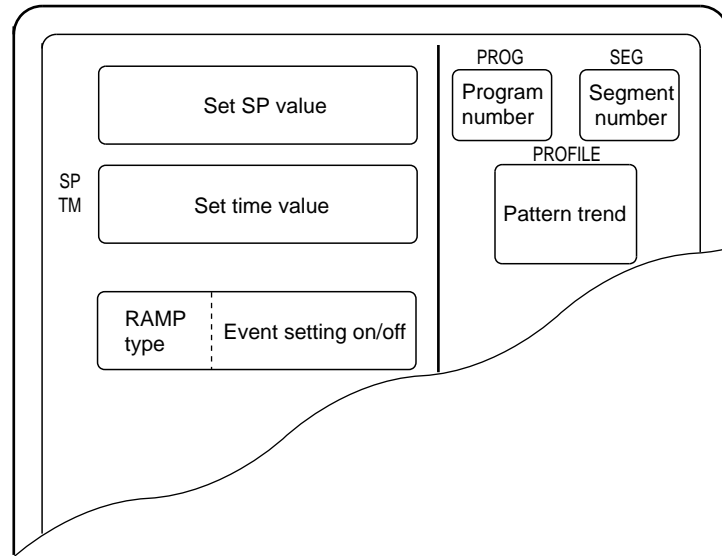

Segments that have not been set and unset values for SP and time are indicated by “ - - - - - ”.

 NOTE

Event settings are displayed in the two rows of the message panel. Events 1 to 8 are displayed in the top row and events 9 to 16 are displayed in the lower row. The meaning of the codes used are listed below.

- : event off
- T : time event
- P : PV/ PV deviation rate event
- D : Deviation/ absolute deviation
- M : MV event
- S : SP event
- C : code/ time code event

■ Setting event items

! Handling Precautions

Note that when setup data C57 is set to 1, event items on the programming map are skipped and not displayed.

● When the event is a PV event

- (1) In the set value display state, move to the segment event item to be set on the programming map.
- (2) Press the **ENTER key** to make display panel 1 flash (registration of first setting) .
- (3) Use the **↑ ↓ ← → keys** to make the first setting – setting the event operating point.
 Setting range : OFF – 19999 to +20000 SPU
 : OFF 0 to 20000 SPU (for absolute value deviation events)
 : OFF –5.0 to +105.0 % (for MV events)
- (4) Press the **ENTER key** to stop the flashing on display panel 1 . (Pressing the **FUNC** and **CLR keys** causes display panel 1 to return to unset state “ - - - - - ” and the flashing stops.)

● Display (PV events)

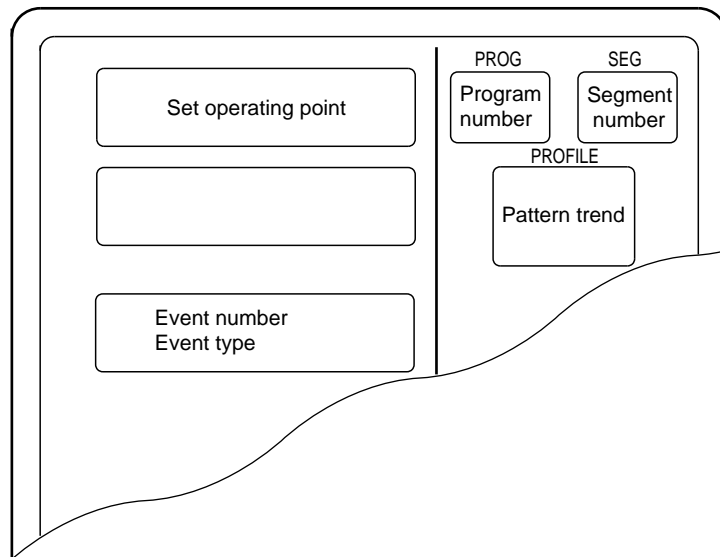

Unset values are indicated as “ - - - - - ”.

NOTE

A PV event setting consists of a setting (including OFF) and a subfunction. A subfunction cannot be used when a setting has not been made “ - - - - - ”.

● **When the event is a time event**

- (1) In the set value display state, move to the event item to be set for the segment on the programming map.
- (2) Press the **ENTER key** to make display panel 1 flash (registration of first setting) .
- (3) Use the **↑ ↓ ← → keys** to make the first setting (On Time setting) .
Setting range: 0 : 00 to 5 00 : 00 , 0 . 0 to 3 000 . 0
(Time units are selected using setup data **C62** to set Hour/ min, Min/ sec, 0 . 1 sec. Since a colon “ : ” cannot be displayed, the decimal point is used instead.)
- (4) Press the **ENTER key** to stop the flashing on display panel 1 and display panel 2 starts flashing. (Start of second setting)
(Pressing the **FUNC** and **CLR keys** causes display panel 1 and 2 to return to unset state “ - - - - - ” and the flashing stops.)
- (5) Use the **↑ ↓ ← → keys** to make the second setting (Off Time setting) .
Setting range: On time setting + 0 : 0 1 to 5 00 : 00 , Off time setting + 0 . 1 to 3 000 . 0
- (6) Press the **ENTER key** to stop the flashing on display panel 2 .
(Pressing the **FUNC** and **CLR keys** causes display panel 2 to return to unset state “ - - - - - ” and the flashing stops.)

● **Display (time event)**

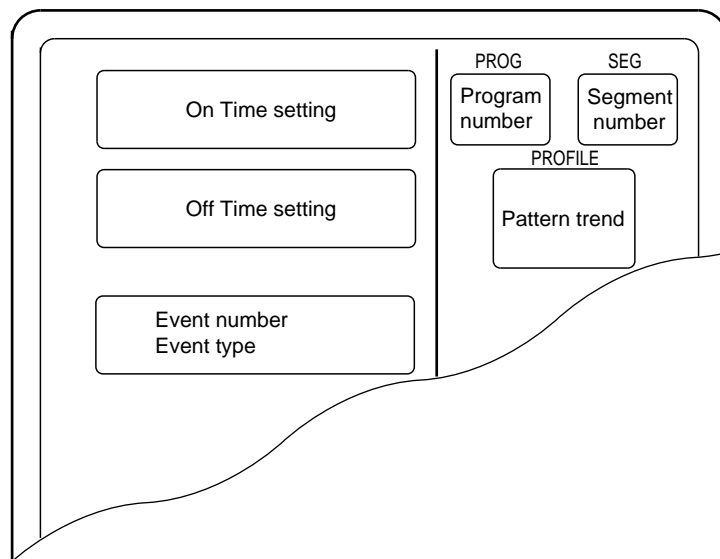

- Unset values are indicated as “ - - - - - ” .
- When the On Time is set to 5 00 : 00 or 3 000 . 0 , an Off Time cannot be set.

NOTE

A time event setting consists of one setting, an On Time, or two settings, an On Time and an Off Time. When both settings are made a subfunction can be used. In unset state “ - - - - - ” a subfunction cannot be used.

Handling Precautions

In a time event, an On Time or Off Time setting that is the same as or exceeds the segment time is invalid.
Note, however, that when there is a G.SOAK wait at the end of a segment or an END mode at the end of a program, an On Time or Off Time setting that is the same as the segment time is valid.

● **When the event is a code event**

- (1) In the set value display state, move to the event item to be set for the segment on the programming map.
- (2) Press the **ENTER key** to make display panel 1 flash (registration of first setting) .
- (3) Use the **↑ ↓ ← → keys** to make the first setting – setting the event output code.
Setting range : 0 to 2ⁿ - 1
(n indicates the number of output points set in event configuration 1 auxiliary setting 1 .)
- (4) Press the **ENTER key** to stop the flashing on display panel 1 .
(Pressing the **FUNC** and **CLR keys** causes display panel 1 to return to unset state “ - - - - - ” and the flashing stops.)

● **Display (code event)**

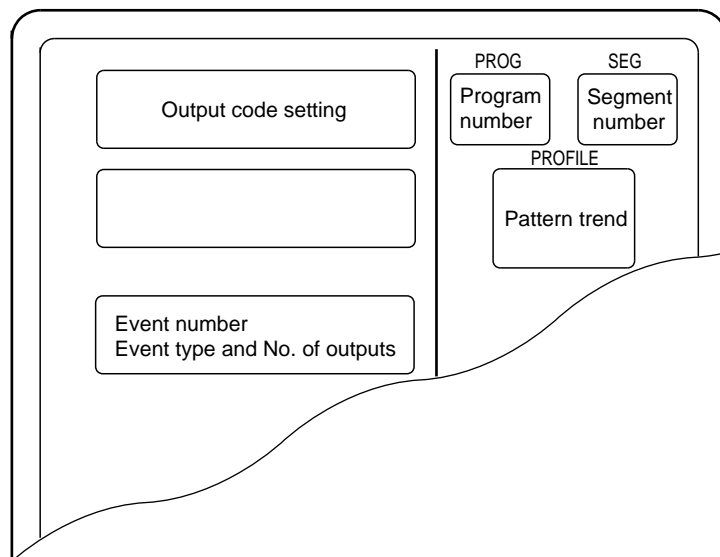

Unset values are indicated as “ - - - - - ” .

 **NOTE**

Code events use one subfunction. A subfunction cannot be used when a setting has not been made “ - - - - - ” .

Events that follow the event number of a code event (number of output points less 1) are skipped and not displayed.

● When the event is a timer code event

- (1) In the set value display state, move to the event item to be set for the segment on the programming map.
- (2) Press the **ENTER key** to make display panel 1 flash (registration of first setting) .
- (3) Use the **↑ ↓ ← → keys** to make the first setting (output code) .
 Setting range: 0 to 2ⁿ- 1
 (n indicates the number of output points set in event configuration 1 auxiliary setting 1 .)
- (4) Press the **ENTER key** to stop the flashing on display panel 1 and display panel 2 starts flashing. (Start of second setting)
 (Pressing the **FUNC** and **CLR keys** causes display panel 1 and 2 to return to unset state “ - - - - ” and the flashing stops.)
- (5) Use the **↑ ↓ ← → keys** to make the second setting (time) .
 Setting range: 0 : 00 to 500 : 00, 0 . 0 to 3000 . 0
 (Time units are selected using setup data C64 to set Hour/ min, Min/ sec, 0 . 1 sec. Since a colon “ : ” cannot be displayed, the decimal point is used instead.)
- (6) Press the **ENTER key** to stop the flashing on display panel 2.
 (Pressing the **FUNC** and **CLR keys** causes display panel 1 and 2 to return to unset state “ - - - - ” and the flashing stops.)

● Display (Code event with a timer function)

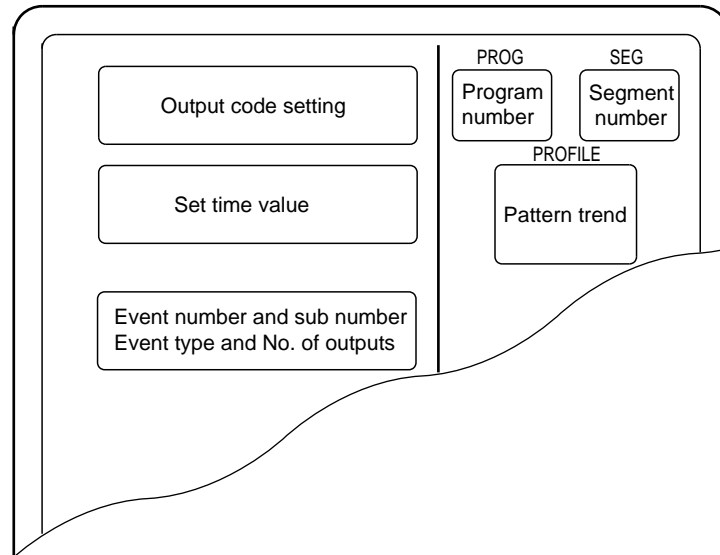

Unset values are indicated as “ - - - - - ” .

 **NOTE**

Timer code events use one subfunction. A subfunction cannot be used when a setting has not been made “ - - - - - ” .

Events that follow the event number of a timer code event (number of output points less 1) are skipped and not displayed.

Handling Precautions

In a timer code event, an On Time or Off Time setting that is the same as or exceeds the segment time is invalid.

Note, however, that when there is a G.SOAK wait at the end of a segment or an END mode at the end of a program, an On Time or Off Time setting that is the same as the segment time is valid.

- **When the event is an event off**

Such event items on the programming map are skipped and not displayed.

- **When the event is an instrument event**

Such event items on the programming map are skipped and not displayed.

■ Setting PID groups and output limiter group number items

- (1) In the set value display state, move to the PID group, output limiter group number item to be set for the segment on the programming map.
- (2) Press the **ENTER** key to make display panel 1 flash (registration of first setting) .
- (3) Use the **↑, ↓, ←, →** keys to make the first setting (PID group number) .
Setting range: ON- OFF, PID 0 to 9, PID A
- (4) Press the **ENTER** key to stop the flashing on display panel 1 and display panel 2 starts flashing. (Start of second setting)
(Pressing the **FUNC** and **CLR** keys causes display panel 1 and 2 to return to unset state “*Pld 0/otL 0*” and the flashing stops.)
- (5) Use the **↑, ↓, ←, →** keys to make the second setting (output limiter group number) .
Setting range: 0 to 9
- (6) Press the **ENTER** key to stop the flashing on display panel 2 .
(Pressing the **FUNC** and **CLR** keys causes display panel 2 to return to unset state “*Pld 0/otL 0*” and the flashing stops.)

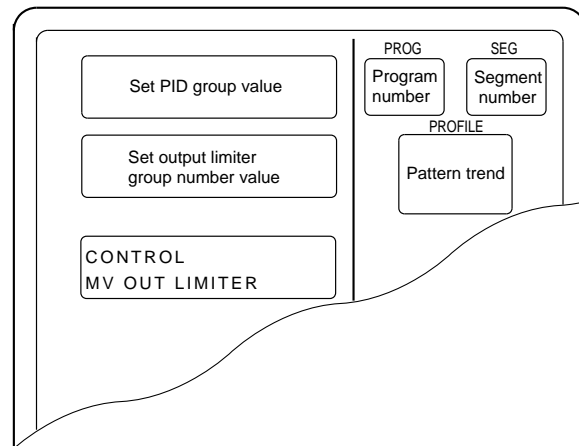

● Display

- Unset values are indicated as “*Pld 0/otL 0*” .
- When setup data *C21* is set to 0 and the programmer function is selected or when *C58* is set to 1, PID groups, output limiter group number items are skipped and not displayed.

📖 NOTE

When a PID group or output limiter group number is not 0 or both are something other than 0, they use a subfunction. A subfunction cannot be used when a setting has not been made “*Pld 0/otL 0*” .

⚠ Handling Precautions

- When a set value for a PID group number is 0, it is a sequel to a PID number in a previous segment. When the set value for a PID group number in the first segment is 0, the set value is 1.
- When a set value for an output limiter group number is 0, it is a sequel to an output limiter group number in a previous segment. When the set value for an output limiter group number in the first segment is 0, the set value is 1.

■ Setting G.SOAK (Guarantee soak) items

- (1) In the set value display state, move to the G. SOAK item to be set for the segment on the programming map.
- (2) Press the **ENTER key** to make display panel 1 flash (registration of first setting) .
- (3) Use the **↑, ↓, ←, → keys** to make the first setting – setting the G. SOAK type.
Setting range: 0 to 3
0: No G. SOAK
1: First G. SOAK segment
2: Last G. SOAK segment
3: Entire G. SOAK segment
- (4) Press the **ENTER key** to stop the flashing on display panel 1 and display panel 2 starts flashing. (Start of second setting)
Note, however, that when the first setting is 0, “ - - - - ” is shown in the second panel which does not flash.
(Pressing the **FUNC** and **CLR keys** causes display panel 1 and 2 to return to unset state “g.S.0/- - - - ” and the flashing stops.)
- (5) Use the **↑, ↓, ←, → keys** to make the second setting (G. SOAK width) .
Setting range: 0 to 1 0 0 0 SPU
- (6) Press the **ENTER key** to stop the flashing on display panel 2 .
(Pressing the **FUNC** and **CLR keys** causes display panel 1 and 2 to return to unset state “g.S.0/- - - - ” and the flashing stops.)

● Display

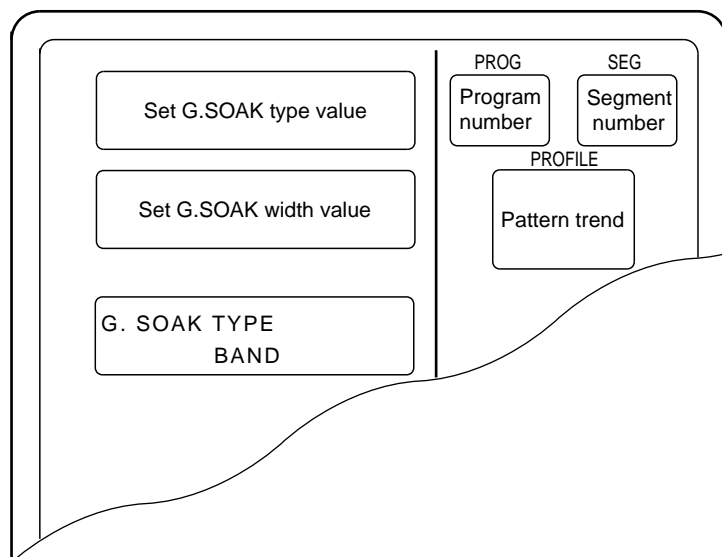

- Unset values are indicated as “g.S.0/- - - - ” .
- When setup data C59 is set to 1 , a G. SOAK item on the programming map is skipped and not displayed.

NOTE

When a G. SOAK setting is something other than 0 , it uses a subfunction.
A subfunction cannot be used when a setting has not been made “g.S.0/- - - - ” .

■ Setting PV shift items

- (1) In the set value display state, move to the PV shift item to be set for the segment on the programming map.
- (2) Press the **ENTER key** to make display panel 2 flash (registration of first setting) .
- (3) Use the **↑ ↓ ← → keys** to make the first setting – setting the PV shift set value.
Setting range: -10000 to +10000 SPU
- (4) Press the **ENTER key** to stop the flashing on display panel 2.
(Pressing the **FUNC** and **CLR keys** causes display panel 1 to return to unset state “ - - - - - ” and the flashing stops.)

● Display

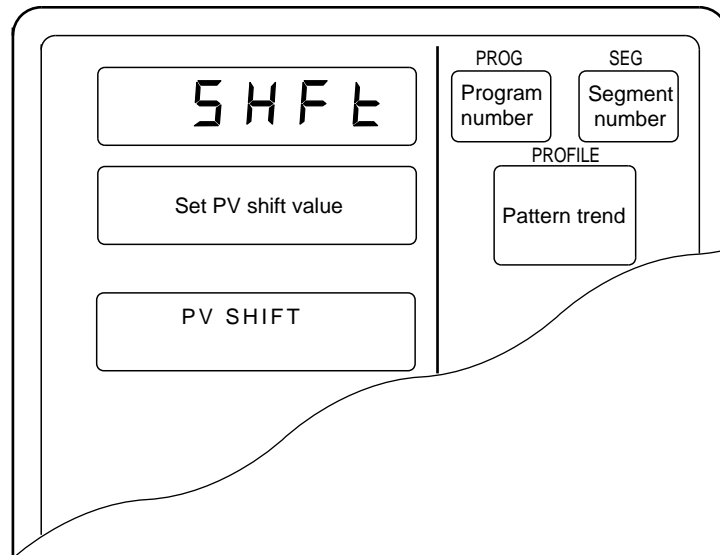

- Unset values are indicated as “ - - - - - ” .
- When setup data C59 is set to 1 , a PV shift item on the programming map is skipped and not displayed.

📖 NOTE

PV shift uses a subfunction. A subfunction cannot be used when a setting has not been made “ - - - - - ” .

⚠ Handling Precautions

When PV shift is not set, it is a sequel to a PV shift value in a previous segment. When PV shift is not set in the first segment, the set value is 0.

■ Setting repeat items

- (1) In the set value display state, move to the repeat item to be set for the segment on the programming map.
- (2) Press the **ENTER key** to make display panel 1 flash (registration of first setting) .
- (3) Use the **↑ ↓ ← → keys** to make the first setting – setting the number of the return segment.
Setting range: 0 to segment number in setting
- (4) Press the **ENTER key** to stop the flashing on display panel 1 and display panel 2 starts flashing. (Start of second setting)
Note, however, that when the first setting is 0, “ - - - - ” is shown in the second panel which does not flash.
(Pressing the **FUNC** and **CLR keys** causes display panel 1 and 2 to return to unset state “rP.0/- - - - ” and the flashing stops.)
- (5) Use the **↑ ↓ ← → keys** to make the second setting (repeat segment times) .
Setting range: 1 to 10000
- (6) Press the **ENTER key** to stop the flashing on display panel 2.
(Pressing the **FUNC** and **CLR keys** causes display panel 1 and 2 to return to unset state “rP.0/- - - - ” and the flashing stops.)

● Display

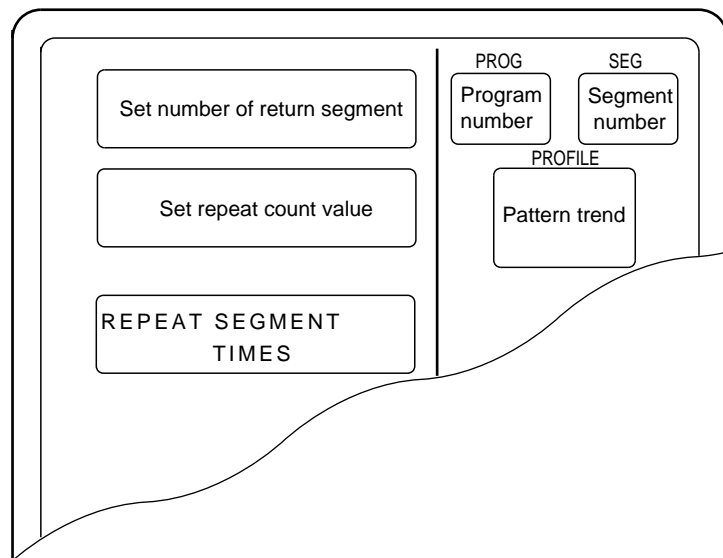

- Unset values are indicated as “rP.0/- - - - ” .
- When setup data C59 is set to 1 , a repeat item on the programming map is skipped and not displayed.

NOTE

When the number of return segment is something other than 0 , it uses a subfunction.

A subfunction cannot be used when a setting has not been made “rP.0/- - - - ” .

■ Setting PV start items

- (1) In the set value display state, move to the PV start item to be set for the segment on the programming map.
(A PV start item is a program setting and is the same for each segment.)
- (2) Press the **ENTER** key to make display panel 2 flash (registration of first setting) .
- (3) Use the **↑**, **↓**, **←**, **→** keys to make the first setting – setting the PV start value.
Setting range: 0 to 3
0 : no PV start
1 : descending PV start
2 : ascending PV start
3 : bi- directional PV start
- (4) Press the **ENTER** key to stop the flashing on display panel 2 .
(Pressing the **FUNC** and **CLR** keys causes display panel 2 to return to unset state “0” and the flashing stops.)

● Display

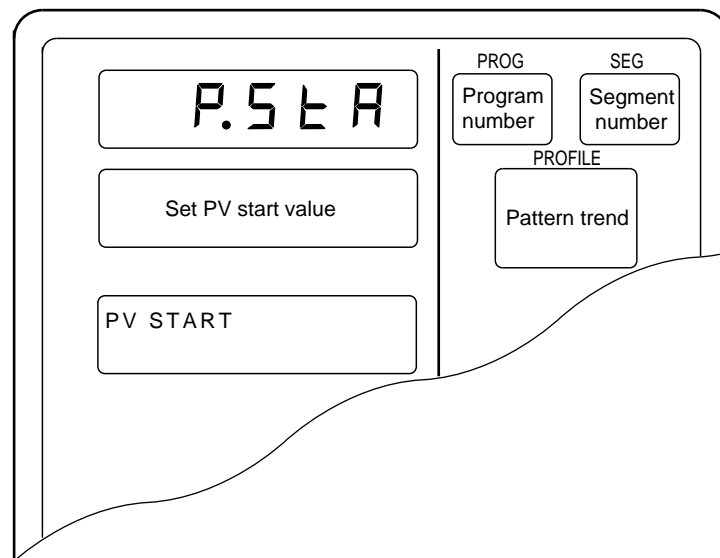

- A PV start item is a program setting and is the same for each segment.
- When setup data C60 is set to 1 , a PV start item on the programming map is skipped and not displayed.

NOTE

A PV start item setting does not use subfunctions.

■ Setting cycle items

- (1) In the set value display state, move to the cycle item to be set for the segment on the programming map.
(A cycle item is a program setting and is the same for each segment.)
- (2) Press the **ENTER key** to make display panel 2 flash (registration of first setting) .
- (3) Use the **↑, ↓, ←, →** keys to make the first setting – setting the cycle value.
Setting range: 0 to 10000
- (4) Press the **ENTER key** to stop the flashing on display panel 2 .
(Pressing the **FUNC** and **CLR keys** causes display panel 2 to return to unset state “0” and the flashing stops.)

● Display

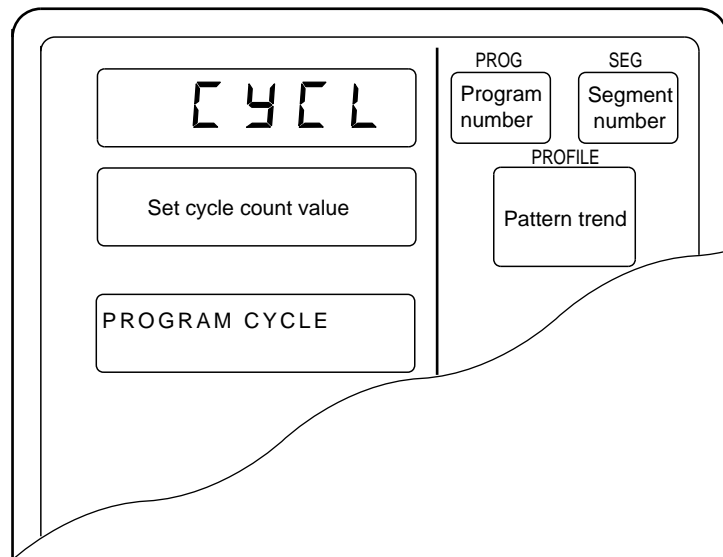

- A cycle item is a program setting and is the same for each segment.
- When setup data *C60* is set to 1, a cycle item on the programming map is skipped and not displayed.

NOTE

A cycle item setting does not use subfunctions.

■ Setting pattern link items

- (1) In the set value display state, move to the pattern link item to be set for the segment on the programming map.
(A pattern link item is a program setting and is the same for each segment.)
- (2) Press the **ENTER key** to make display panel 2 flash (registration of first setting) .
- (3) Use the **↑, ↓, ←, →** keys to make the first setting – setting the pattern link value.
Setting range: 0 to 99
0 :no pattern link
1 to 99 : program number at pattern link destination
- (4) Press the **ENTER key** to stop the flashing on display panel 2 .
(Pressing the **FUNC** and **CLR keys** causes display panel 2 to return to unset state “0” and the flashing stops.)

● Display

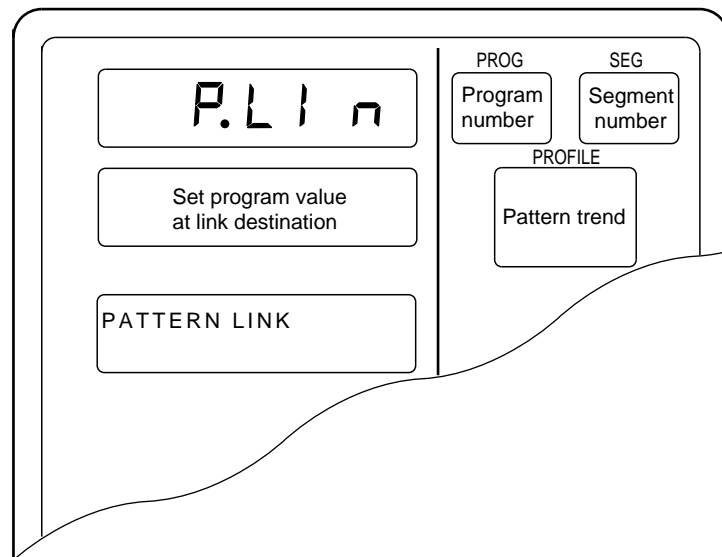

- A pattern link item is a program setting and is the same for each segment.
- When setup data C60 is set to 1 , a pattern link item on the programming map is skipped and not displayed.

NOTE

A pattern link item setting does not use subfunctions.

■ Setting tag items

- (1) In the set value display state, move to the tag item to be set for the segment on the programming map.
(A tag item is a program setting and is the same for each segment.)
- (2) Press the **ENTER key** to display the cursor “_” below the leftmost of the 8 characters in the message panel “ [] ” field (registration of first setting) .
- (3) Use the **↑, ↓, ←, → keys** to make the first setting – selecting the 8 characters for the tag. The table below shows the 128 characters that can be used.
- (4) Press the **ENTER key** and the cursor in the message panel disappears.
(Pressing the **FUNC** and **CLR keys** causes the message panel return to displaying an 8 - character tag consisting of *PROG*”, a two- digit program number and two space characters. The cursor is turned off.)

● Display

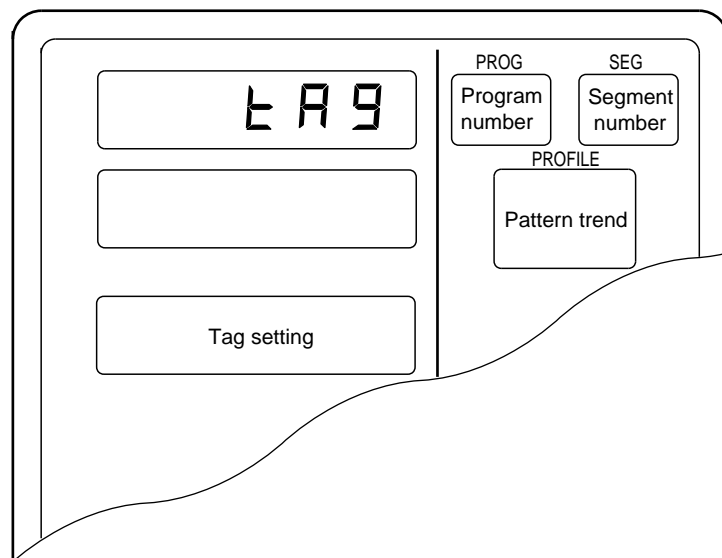

'	/	7	?	G	O	W	_	ア	ツ	キ	ソ	ヌ	マ	ラ	°
&	.	6	>	F	N	V	^	ヲ	ヨ	カ	セ	ニ	ホ	ヨ	°
%	-	5	=	E	M	U]	・	ユ	オ	ス	ナ	ヘ	ユ	ン
\$,	4	<	D	L	T	\	、	ヤ	エ	シ	ト	フ	ヤ	ワ
#	+	3	;	C	K	S	[」	オ	ウ	サ	テ	ヒ	モ	ロ
”	*	2	:	B	J	R	Z	「	エ	イ	コ	ツ	ハ	メ	レ
!)	1	9	A	I	Q	Y	。	ウ	ア	ケ	チ	ノ	ム	ル
	(0	8	@	H	P	X		イ	ー	ク	タ	ネ	ミ	リ

NOTE

A tag item setting does not use subfunctions.

■ Deleting programs

- (1) In the set value display state, move to the start of the segment pattern item to be deleted on the programming map.
Move to the first segment of the program to delete the entire program.
- (2) Press the **ENTER key** to make display panel 1 flash (registration of first setting) . (This the same as for pattern item settings.)
- (3) Press the **FUNC** and **CLR keys** and you are prompted to confirm program deletion. **CLEAR**” flashes in display panel 1 .
- (4) Press the **ENTER key** to delete the program.
- (5) The set value display state appears and “ - - - - - ” is shown in both display panel 1 and 2 .

● Display

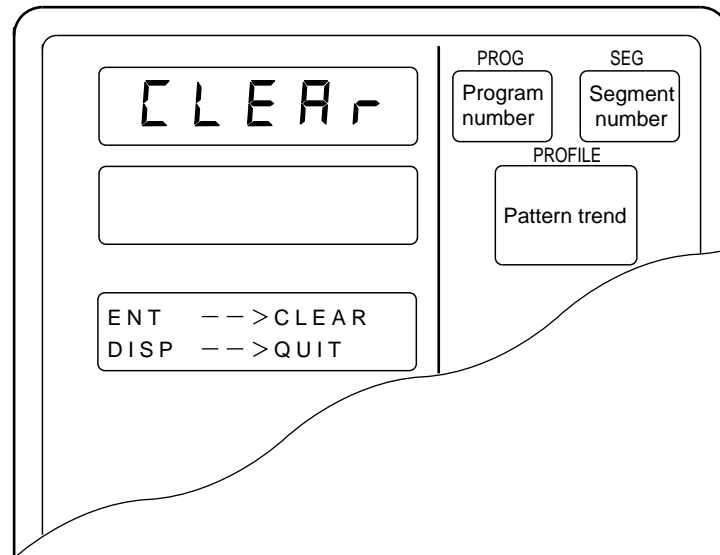

- Segments that have not been set and unset values for SP and time are indicated by “ - - - - - ” .
- A program that is running (in RUN, HOLD, FAST, END or READY FAST mode) cannot be deleted.

■ Inserting and deleting segments

- (1) In the set value display state, move to insert segment or delete segment segment pattern item on the programming map.
- (2) Press the **FUNC** and **ENTER** keys and you are prompted to confirm segment insertion. "InS." flashes in display panel 1 .
- (3) Press the **▲** key and you are prompted to confirm segment insertion. "InS." flashes in display panel 1 . Press the **▼** key and you are prompted to confirm segment deletion. "dEL." flashes in display panel 1 .
- (4) Pressing the **ENTER** key when "InS." is displayed in display panel 1 inserts the segment. Pressing the **ENTER** key when "dEL." is displayed in display panel 1 deletes the segment.
- (5) The set value display state appears.

● Display (segment insertion)

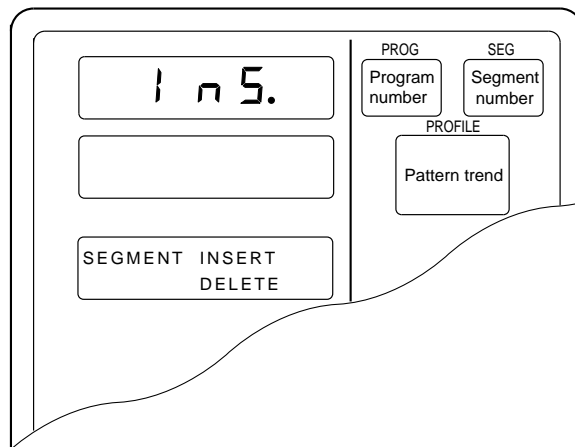

● Display (segment deletion)

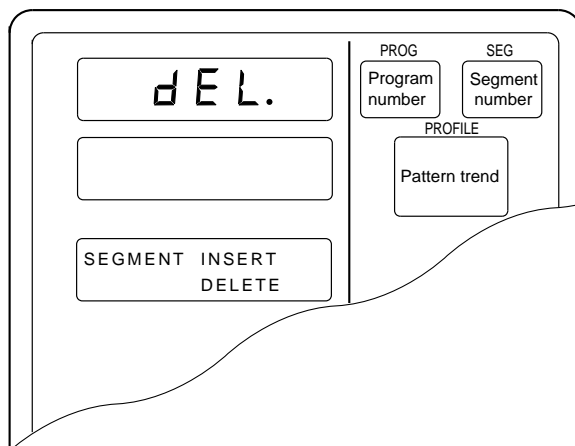

- When a segment is inserted, a new segment is automatically created and the numbers of subsequent segments are incremented by one.

The set value of the inserted segment is as follows:

Set SP value : same value as the original segment before insertion

Set time value : 0 : 1 0 , 1 . 0

Event items, PID groups, output limiter group number items, G. SOAK items, PV shift items and repeat items are not set.

- Then the 99 th segment has already been set, the segment insertion indication “*InS.*” is not displayed.
- When 2000 segments have already been set, pressing **ENTER key** to execute an insertion cannot be used to insert a segment.
- When segments are deleted, the following segments are moved up and the numbers of subsequent segments are decremented by one. When the final segment is deleted, the displayed segment becomes an unset segment.
- A program that is running (in RUN, HOLD, FAST, END or READY FAST mode) cannot be deleted.

8 - 2 Copying Programs

The **DCP551** allows you to copy programs when it is in the **READY** program run mode. If not in this mode, press the **DISP key** to invoke the normal display mode.

■ Program copy procedures

- (1) Invoke the program run **READY** program run mode.
Set variable parameter *PA01* to 0 or 1 and set variable parameter *PA02* to 0.
- (2) Press the **PROG key** and the **↑, ↓, ←, →** keys in the normal display mode to select the number of the program to be copied.
This is not possible when the program number is selected using external switch inputs.
See “Section 6-3 Selecting Programs” (page 6-7) for details.
- (3) Press the **▲ key** and the **PROG key** to display “**COPY**” in display panel 1.
The number of the program to be copied starts to flash in display panel 2.
- (4) Press the **▲, ↓** keys and currently unset program numbers that can be used as numbers for the program to be copied start to flash.
When there are no unset numbers, “- - - -” is displayed in display panel 2.
- (5) Press the **ENTER key** to start program copy and display panel 2 stops flashing. Repeat steps (4) and (5) to copy more programs.
- (6) When a program has been copied, press **DISP key**.

● Display

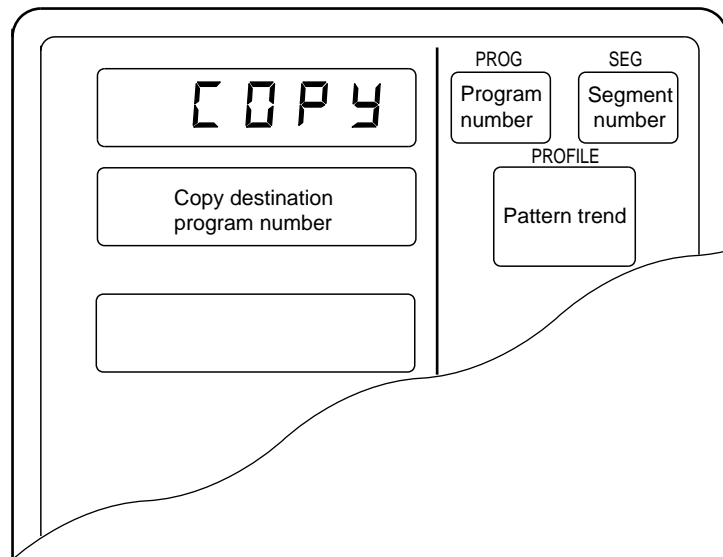

8 - 3 General Reset

A general reset can be performed when the controller is in the READY AUTO mode in the normal display mode. If not in the normal display mode, press the **DISP key** to invoke it. A general reset has the following functions. Program settings such as program numbers 1 to 99 are all deleted. Parameters are reset to their factory defaults and the READY AUTO program run mode is invoked.

■ General reset procedures

- (1) Invoke the READY AUTO mode. Or set variable parameters **PA01** and **PA02** to 0.
- (2) Press the **FUNC**, **CLR** and **MESSAGE keys** and you are prompted to confirm a general reset. **g.rEst** is displayed in display panel 1.
- (3) Press the **ENTER key** to execute the general reset and start startup operations that occur after a power up.
Press the **DISP key** cancels the general reset and returns the normal display mode.

● Display

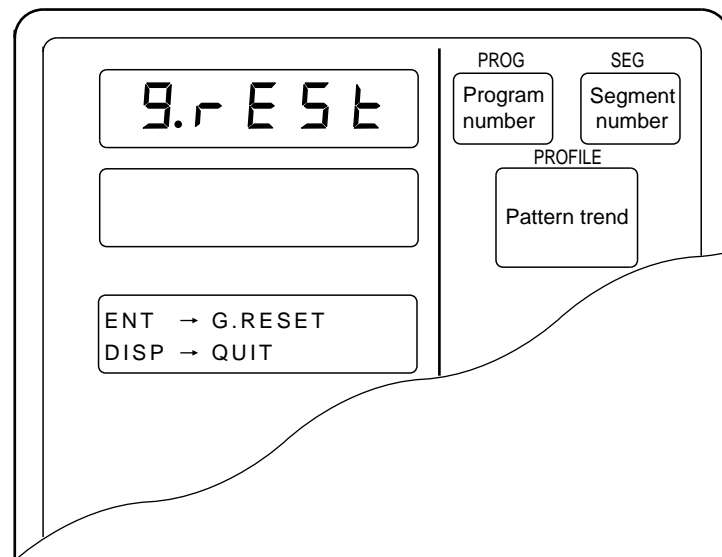

In the constant value control mode, program number, segment number and profile display go off.

- When the RAM backup fails at startup, the controller automatically prompts you to confirm a general reset – no key input is required - and **g.rEst** flashes in display panel 1.
Press the **ENTER key** to execute the general reset. All other keys are invalid.
- A general reset does not return the following settings to factory default values.
C01, C02, C11, C12, C21: these values are stored.
Note, however, that a general reset resulting from a RAM failure at startup resets also these settings to factory default values.

Chapter 9. MEMORY CARD OPERATIONS

9 - 1 Memory Card Type and Functions

A memory card can be used to store the setup data, variable parameters, PID parameters (including constant value control data), event configuration data and multiple programs required by one **DCP551**.

 **NOTE**

- This chapter is not applicable to the **DCP551B******* model.

- **Memory card types**

The following memory cards can be used by the **DCP551**.

Model No.	Memory type	Battery	Capacity (Byte)	No. of programs
SKM008A	RAM	Not replaceable	7.00K	Max. 20
SKM016A	RAM	Not replaceable	14.50K	Max. 52
SKM064A	RAM	Not replaceable	61.75K	Max. 99
SKM256C	RAM	Replaceable	251.00K	Max. 99
SKM008E	E ² PROM	Not necessity	7.00K	Max. 20
SKM032E	E ² PROM	Not necessity	29.75K	Max. 99

- **Memory card functions**

- **Save: (write)**
Saves selected **DCP551** data on the memory card.
- **Load: (read)**
Loads selected memory card data onto the **DCP551**.

9 - 2 Save Procedures

Insert a memory card when the **DCP551** is in the **READY** mode and the normal display mode. Press the **SAVE key** to start a save operation. “*CArd*” is displayed in display panel 1 and “**SAVE**” is displayed in display panel 2. An error code appears if something should go wrong during the save operation.

■ Save menu

When the **SAVE key** is pressed in the normal display mode, the save menu panel is displayed. Use the **↑** and **↓** **keys** to select the desired menu.

Press the **ENTER key** to display the desired menu in the message display panel.

The **DISP key** returns you to the normal display mode.

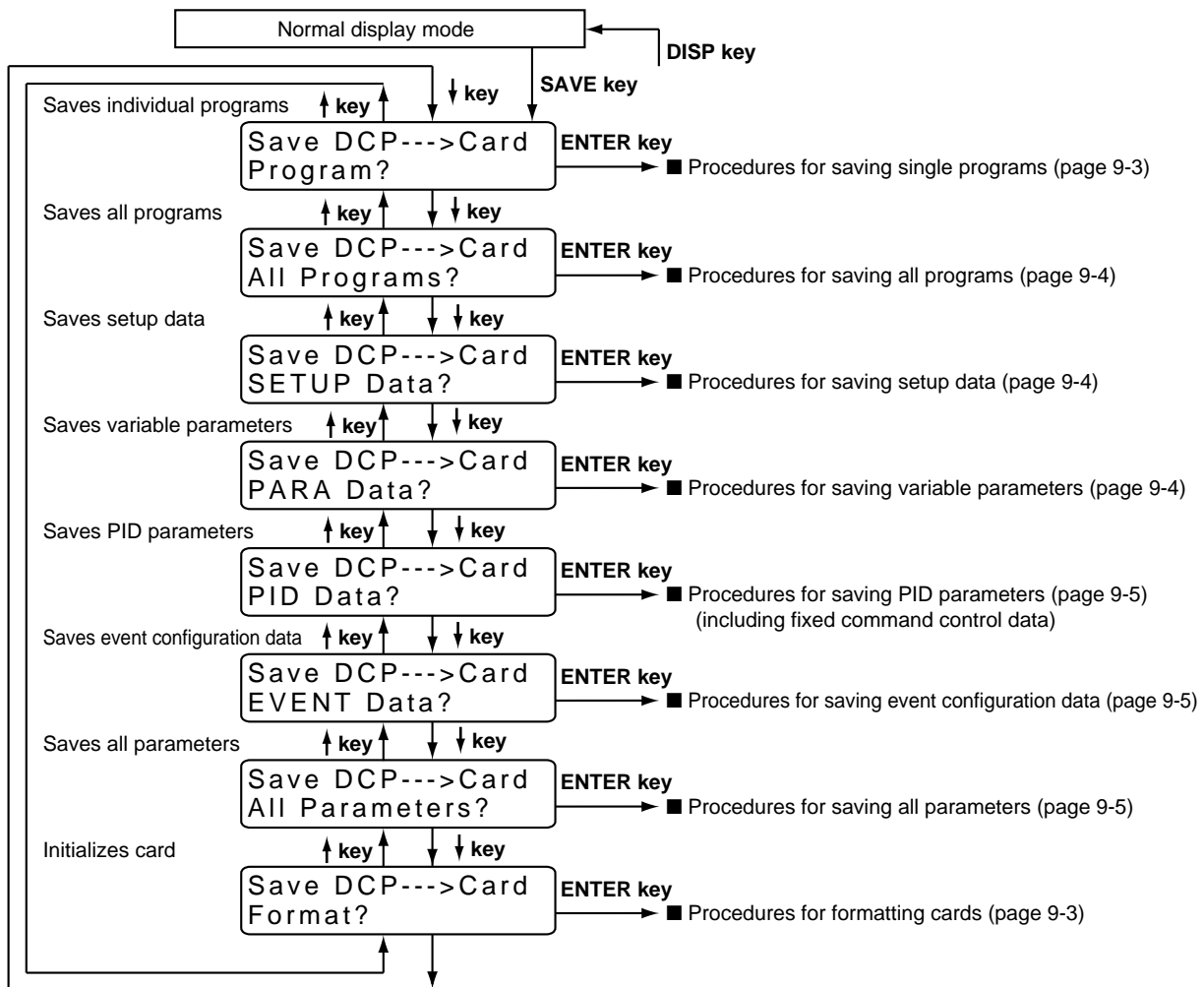

■ **Procedures for formatting cards**

This procedure is used to format memory cards so that they can be used with the **DCP551**. A card has to be formatted once only. Note that any programs or parameters on a card that is formatted are deleted in this process.

Initialize check

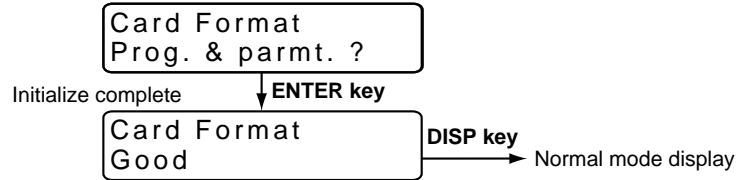

■ **Procedures for saving single programs**

This procedure is used to save one program on the DCP to a memory card.

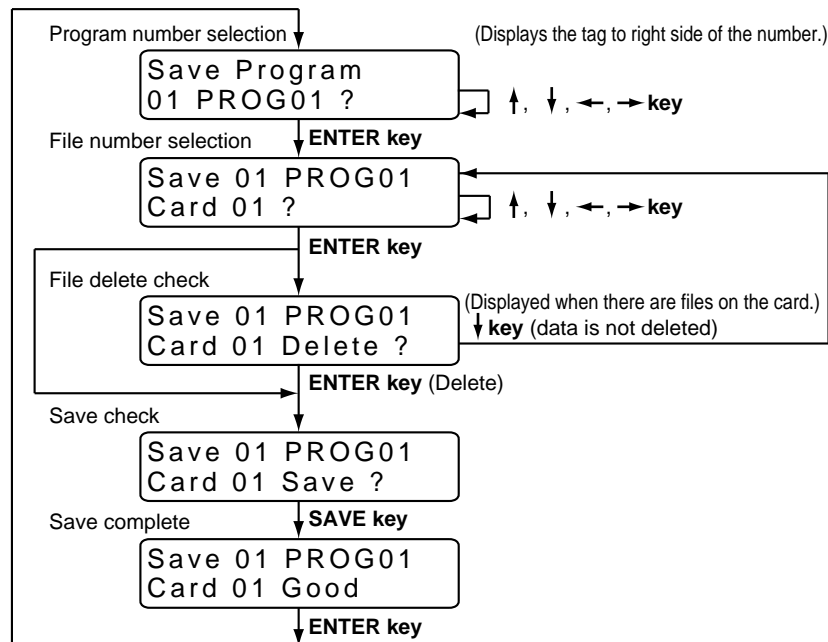

■ **Procedures for saving all programs**

This procedure saves all programs on the **DCP551** on a memory card. The program numbers used in the **DCP551** are converted to file names on the memory card.

When the “Overwrite” save function is selected, files on the card that have the same number as those in the **DCP551** are overwritten by the **DCP551** files.

When the “Skip” save function is selected, files on the card that have the same number as those in the **DCP551** are left as they are and the next number file is selected for processing.

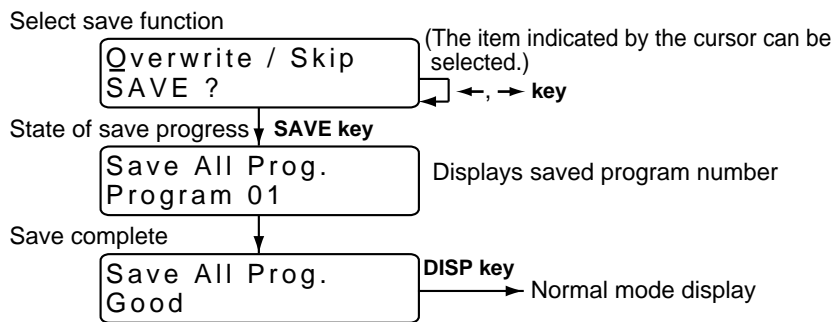

■ **Procedures for saving setup data**

This procedure saves the **DCP551** setup data on a memory card.

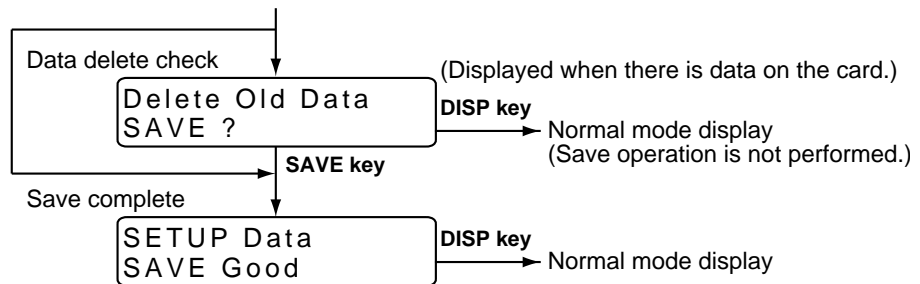

■ **Procedures for saving variable parameters**

This procedure saves the **DCP551** variable parameter data on a memory card.

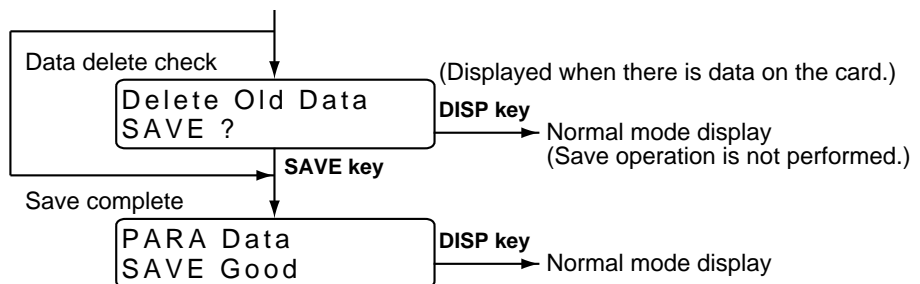

■ Procedures for saving PID parameters

This procedure saves PID parameters and constant value control data on a memory card.

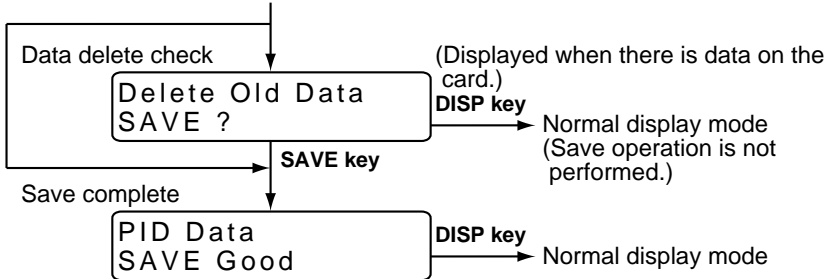

■ Procedures for saving event configuration data

This procedure saves event configuration data on a memory card.

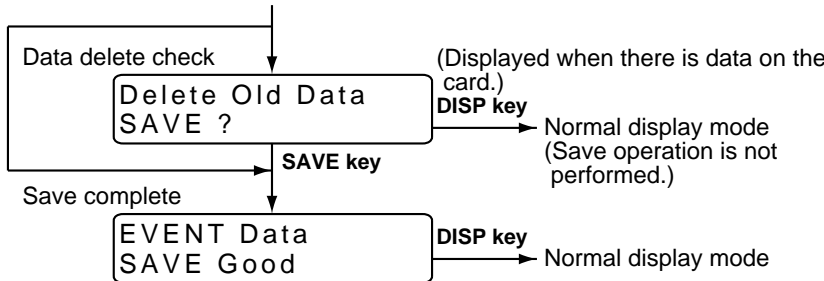

■ Procedures for saving all parameters

This procedure saves all parameters on a memory card.

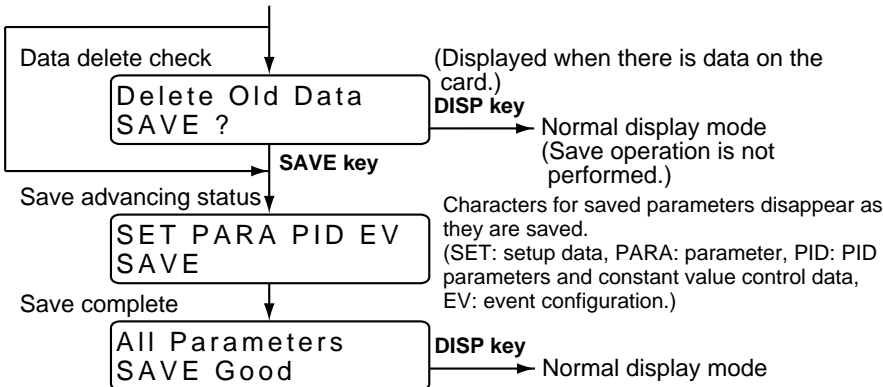

9 - 3 Load Procedures

Insert a memory card when the **DCP551** is in the **READY** mode and the normal display mode, and variable parameter *PA05* has been set to 0. Press the **LOAD key** to start a load operation. “*CArd*” is displayed in display panel 1 and “*LOAD*” is displayed in display panel 2. An error code appears if something should go wrong during the save operation.

■ Load menu

When the **LOAD key** is pressed in the normal display mode, the load menu panel is displayed. Use the **ENTER key** to select the desired menu.

Press the **ENTER key** to display the desired menu in the message display panel.

The **DISP key** returns you to the normal display mode.

Note, however, that an autoloading operation is performed when the **LOAD key** is pressed and variable parameter *PA05* is set to 1.

For details, see “Section 9-4 Autoload” (page 9-10).

A RAM memory card whose internal batteries are too low, cause a card battery alarm panel to be displayed before the Load menu panel is displayed.

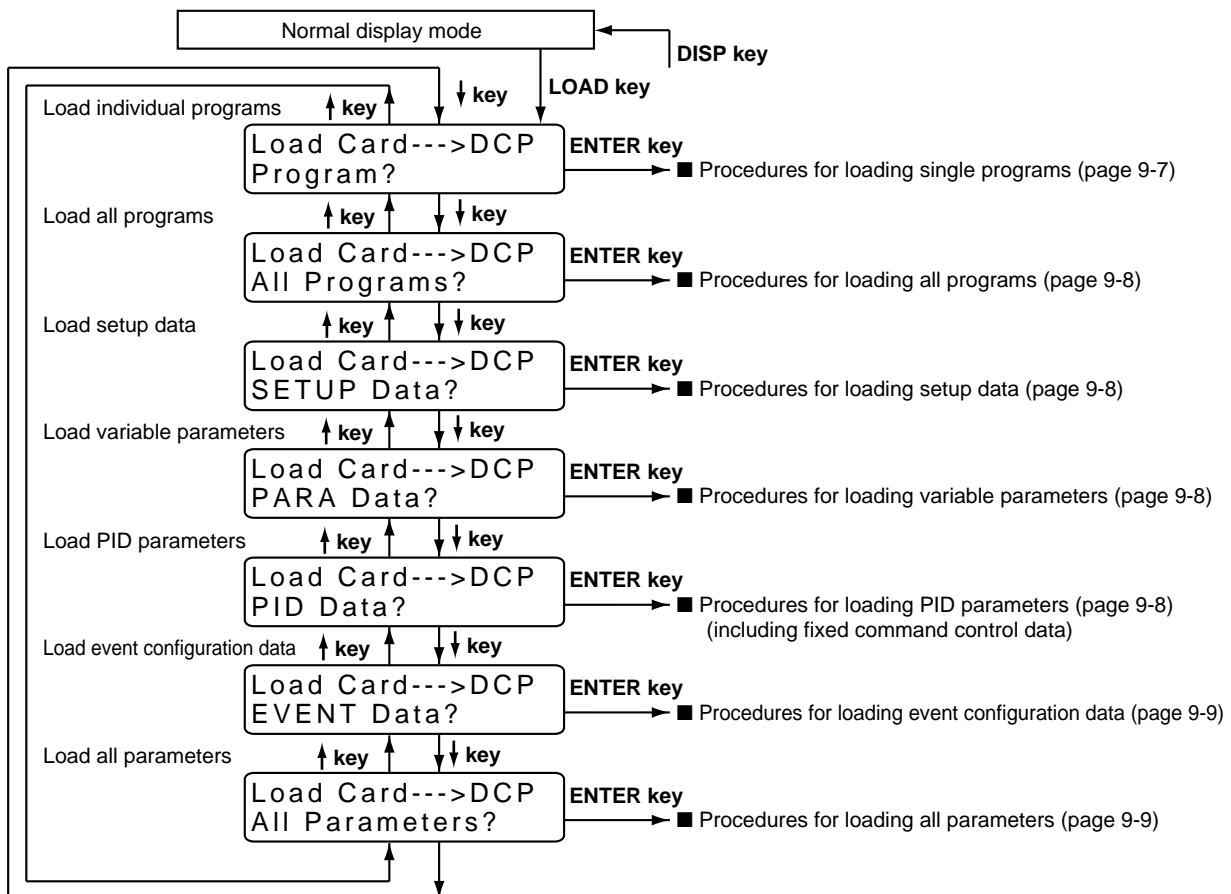

■ Card battery alarm panel

When the voltage of the internal battery in a RAM card is too low, the data saved on the disk may be corrupted. Loading corrupted data onto the DCP551 will cause maloperation. Do not use a card whose battery voltage is too low. If you want to load the data anyway, select "Ignore" in this panel and press the ENTER key. This displays the load menu. To return to the normal display mode, select "Quit" or press the ENTER key or the DISP key.

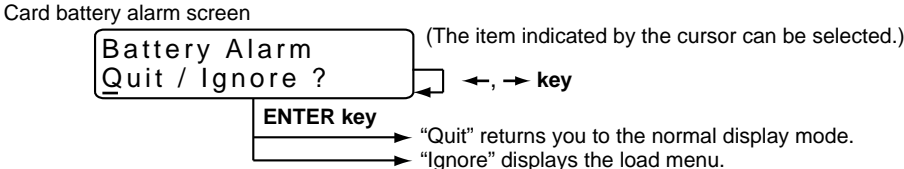

■ Procedures for loading individual programs

This procedure loads single memory card files on the DCP551.

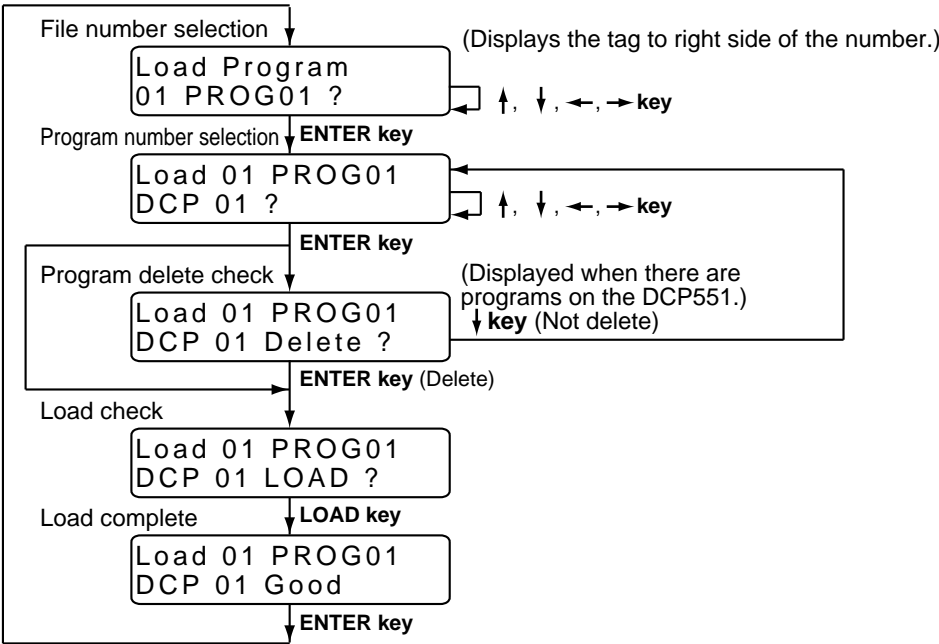

■ Procedures for loading all programs

This procedure loads all programs on the memory card in the **DCP551**. The file numbers used on the memory card are converted to file numbers used in the **DCP551**.

When the “Overwrite” load function is selected, programs in the **DCP551** that have the same number as those on the card are overwritten by the card programs. When the “Skip” load function is selected, programs in the **DCP551** that have the same number as those on the card are left as they are and the next number is selected for processing.

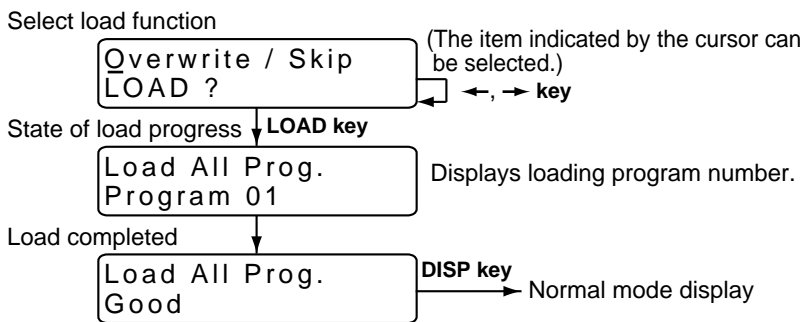

■ Procedures for loading setup data

This procedure loads setup data on the memory card onto the **DCP551**.

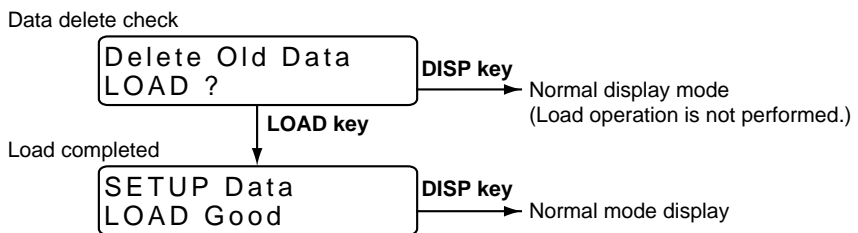

■ Procedures for loading variable parameters

This procedure loads variable parameters on the memory card onto the **DCP551**.

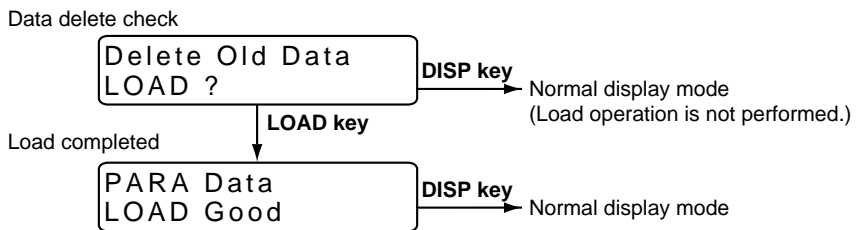

■ Procedures for loading PID parameters

This procedure loads PID parameters and constant value control data on the memory card onto the **DCP551**.

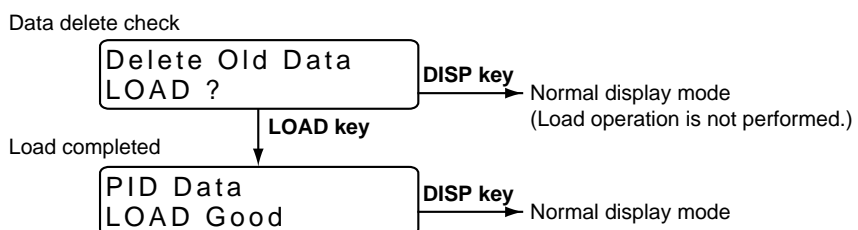

■ Procedures for loading event configuration data

This procedure loads event configuration data on the memory card onto the **DCP551**.

Data delete check

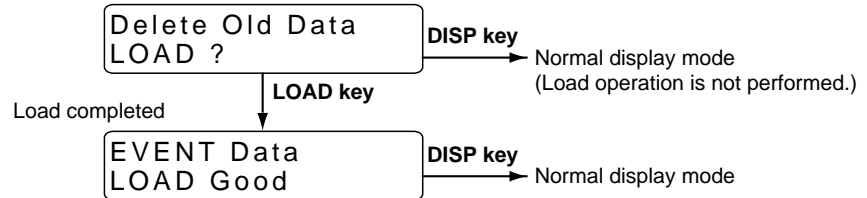

■ Procedures for loading all parameters

This procedure loads all parameters on the memory card onto the **DCP551**.

Data delete check

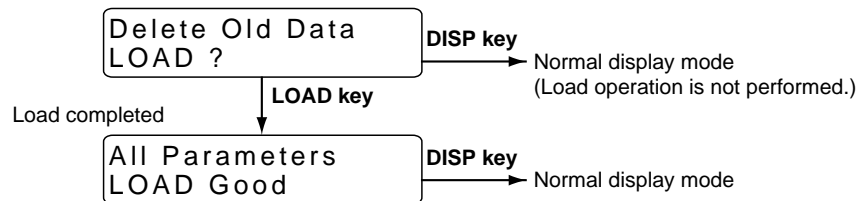

! Handling Precautions

The **DCP551 Mark II** and the old model, **DCP551**, differ in how some setup data items are processed and the range of variable parameter *PA15*. Thus the following changes have to be made when setup data, variable parameters or all parameters saved on a **DCP551** are loaded onto a **DCP551 Mark II**.

- Setup data : C21, C45 to C50, C52, C53, C80, C90 to C97
- Variable parameters : PA15

Setup data and all parameters stored on a **DCP551 Mark II** cannot be loaded onto a **DCP551**. (A loading attempt generates card error 16.)

9 - 4 Autoload

Insert a memory card, press the **LOAD key** or use external switch inputs in the **READY** mode and the normal display mode to load file number 1 on the memory card as program 1 onto the **DCP551**.

■ Key operated autoload procedure

● Conditions

Memory card : Program has been saved to file number 1
 Variable parameter : *PA05* set to 1
 Mode : **READY** mode, normal display mode

● Operation and action

Insert a memory card and press the .

The **DCP551** operates as follows.

“*AUtO*” is displayed in display panel 1 and “*LOAd*” is displayed in display panel 1.

- When program number 1 has been loaded onto the **DCP551**, program number 1 disappears.
- File number 1 on a memory card is loaded onto the **DCP551** as program number 1.
- When a load operation is successful, the “*AUtO*” and “*LOAd*” indications go off and the normal display mode appears.
 Unless the number of a program is selected using external switch inputs, program 1 in segment 1 is selected.
- If the load operation fails, the “*AUtO*” and “*LOAd*” indications stay on and an error code is displayed in the message panel.
 When an error has occurred, press the **DISP key** to return to the normal display mode.

! Handling Precautions

A normal load operation cannot be performed when variable parameter *PA05* is set to 1. A normal load operation requires that this parameter is set to 0.

■ Auto load using external switch inputs

● Conditions

Memory card : Program saved to file number 1
 Setup data : any of *C71* to *C74* is set to 8 (autoload)
 Mode : READY mode, normal display mode

● Operation and action

Insert a memory card and turn off the external switch used for autoload and turn it back on again.

The **DCP551** operates as follows.

- “*AUtO*” is displayed in display panel 1 and “*LOAd*” is displayed in display panel 2.
- When program number 1 has been loaded onto the **DCP551**, program number 1 disappears.
- File number 1 on a memory card is loaded onto the **DCP551** as program number 1.
- When a load operation is successful, the “*AUtO*” and “*LOAd*” indications go off and the normal display mode appears.
 Unless the number of a program is selected using external switch inputs, program 1 in segment 1 is selected.
- If the load operation fails, the “*AUtO*” and “*LOAd*” indications stay on and an error code is displayed in the message panel.
 When an error has occurred, press the **DISP key** to return to the normal display mode.

! Handling Precautions

Variable parameter *PA05* can be set to 1 or 0.

9 - 5 Error Message List

When an error occurs, error messages such as “Card Error-XX” (XX denotes error code) are displayed on the message panel during memory card operations. The table below lists the error codes and explain their meaning. Memory card operations are aborted when an error occurs.

To return to the normal display mode, press the **DISP** key.

Code	Meaning	Remedial measures
1	Card insertion failure or card removed	Do over.
2	Card write protect	Replace the card, or reset the protect by SLP550.
3	Card read protect	Replace the card, or reset the protect by SLP550.
4	Bad card	Replace the card.
5	Invalid card format	Initialize the card.
6	Card data full	Erase unnecessary files, or initialize the card.
7	Card busy	Do over.
8	File write protect	Initialize the card.
9	Card access error	Do over.
11	Card access sequence error	Do over.
12	FAT abnormal	Initialize the card.
14	Card access sequence error (in file control)	Do over.
15	Card battery voltage drop (warning)	Replace the card, replace the card battery (If replaceable).
16	Wrong file version	Create new file, and create new data.
17	Data or file are missing.	Create new file, and create new data.
18	DCP551 data full (program load)	Delete unnecessary programs in the DCP551 .
19	DCP551 hardware error (load error)	Do over.
20	Card data invalid	Do over.
21	Card data check sum error (program data)	Operate the instrument again, or check the program setting of the DCP551 .
22 to 36	Card data check sum error (parameter data)	Operate the instrument again, or check the parameter setting of the DCP551 .
37	Memory protect error (loading the data is protected by the variable parameter PA02.)	Set DCP551 variable parameter PA02 to 0 to cancel protection.
43	No alternate areas remain on the EEPROM card	Replace the card.
44	Error occurred in writing to alternate area on EEPROM card	Replace the card.
63	Card battery voltage drop (error)	Replace the card, replace the card battery (If replaceable).
64	File abnormal (card was removed)	Create new file, and create new data.

Chapter 10. TROUBLESHOOTING

10 - 1 Self-Diagnostic Functions and Alarm Code Displays

The **DCP551** is equipped with the self-diagnostic functions described below. Alarm codes and the result of self-diagnostics are listed on the following pages.

■ Power ON self-diagnostic routines

- **RAM backup failures**

This routine is designed to detect errors in the RAM backup function. When a failure is detected, a general reset is performed. No alarm code is displayed.

- **Board configuration failures**

This routine detects failures caused when boards (circuit boards) not designed to be used with the **DCP551**. Alarm codes are displayed when errors are detected.

■ Self-diagnostic routines performed each sampling cycle

- **Analog input failures**

Failures are detected when the analog input signal due to disconnection or other cause lies outside the -10.0 to $+110.0\%$ range.

Alarm codes are displayed when errors are detected.

■ Self-diagnostic routines performed continuously during operation

- **PROM failures**

This routine is designed to detect errors in system programs stored in the PROM. Not totally infallible, there are cases where errors go undetected and result in measuring device operation failure.

Alarm codes are displayed when errors are detected.

- **Adjustment data failures**

This routine detects errors in analog inputs and output adjustment data stored in non-volatile memory. Alarm codes are displayed when errors are detected.

- **Program failures**

This routine detects failures in program setting data stored in a backup RAM. Alarm codes are displayed when errors are detected..

- **Parameter failures**

This routine detects failures in parameters stored in a backup RAM. Alarm codes are displayed when errors are detected.

- **Low battery voltage**

This routine detects low voltage conditions in the battery that backups RAM data. The BAT LED on the console goes on when battery voltage is too low.

■ Alarm code display

The **DCP551** is designed to alternate display of the following alarm codes and normal display items in one-second intervals on display panel 1 when input failures or instrument system failures are detected.

In cases of multiple alarm codes, display of the codes is alternated with normal display items, starting in order from the alarm code with the smallest number.

■ Alarm classification

PV range alarm group : *AL01* to *AL04*

Measuring instrument alarm group : *AL90* to *AL99*, and battery voltage drop
(In case of battery voltage drop, BAT LED of the console is flickered.)

Alarm code	Alarm name	Contents	Countermeasure
<i>AL01</i>	PV1 overrange	PV1 is more than 110%FS.	Check PV1.
<i>AL02</i>	PV1 underrange	PV1 is less than -10%FS.	
<i>AL03</i>	PV2 overrange	PV2 is more than 110%FS.	Check PV2
<i>AL04</i>	PV2 underrange	PV2 is less than -10%FS.	
<i>AL90</i>	Board configuration failure	Incorrect board configuration	Request the repair.
<i>AL92</i>	Adjustment value is abnormal.	Analog input/output adjustment data were broken.	Request the repair.
<i>AL93</i>	Setup data is abnormal.	Setup data were broken.	Check the setup data, and reset the data.
<i>AL94</i>	Variable parameter is abnormal.	Variable parameter were broken.	Check the variable parameter, and reset the data.
<i>AL95</i>	PID parameter is abnormal. (Fixed command control data is abnormal.)	PID parameter were broken.	Check the PID parameter, and reset the data.
<i>AL96</i>	Program data is abnormal.	Program data were broken.	Check the program data, and reset the data.
<i>AL97</i>	Event configuration data is abnormal.	Event configuration data were broken.	Check the event configuration data, and reset the data.
<i>AL99</i>	PROM is abnormal.	System program were corrupted.	Request the repair.

*1: When *AL90* is generated, the alarm code stays on and continued operation is disabled.

*2: Data checks performed by *AL93* and *AL97* may fail to detect corrupted data. When this happens, the alarm can be turned off by entering normal data.

■ Display behavior and alarm code upon input burnout

Display behavior (upscale/downscale) and alarm code upon input burnout differ depending on the input type. Procedures to correct key input related problems are described below.

Input type	Display behavior	Alarm code
Thermocouple	Upscale(110%)	AL01 or AL03
Resistance temperature detector	Upscale(110%)	AL01 or AL03
DC voltage 1V or less	Upscale(110%)	AL01 or AL03
DC voltage 5V or more	Downscale(-10%)	AL02 or AL04
DC current	Downscale(-10%)	AL02 or AL04

10 - 2 Key Input Related Problems

Procedures to correct key input related problems are described below.

■ Normal display mode problems

● Mode cannot be changed using keys

Cause	Measure
Normal display mode not on	Press DISP key to invoke normal display mode.

● Program number does not start flashing when PROG key is pressed

Cause	Measure
Program selection of external switch input is not 0.	Turn off all external switch inputs SW9 to 16.
Not set to READY mode.	Set READY mode to execute RESET operation (PROG + RUN/HOLD keys).
Set to fixed command control mode.	Set fixed command control data <i>ConSt</i> setting to 0.
Set to key lock.	Set variable parameter <i>PA01</i> between 0 to 2.

● RUN mode cannot be invoked with the RUN/HOLD key

Cause	Measure
Program selected in READY mode is unset.	Select the set program.
Set to END mode.	Set READY mode to execute RESET operation (PROG + RUN/HOLD keys).
Set to key lock.	Set variable parameter <i>PA01</i> between 0 to 2.

● HOLD mode cannot be invoked with the RUN/HOLD key

Cause	Measure
Set to READY or FAST mode.	The HOLD mode is available from READY and FAST modes by pressing the RUN key . Press the RUN/HOLD key once again.
Set to END mode.	Perform a reset operation (press the PROG, RUN and HOLD keys). Invoke the READY mode and perform a RUN operation (press the RUN/HOLD key) to go to the RUN mode.
Set to constant value control mode.	Set constant value control data <i>ConSt</i> to 0.
Set to key lock.	Set variable parameter <i>PA01</i> between 0 to 2.

● RESET cannot be performed with the PROG, RUN and HOLD keys.

RESET is available in the READY program run mode and returns operations to the first segment.

Cause	Measure
Set to READY mode.	Perform a RUN operation (press the RUN/HOLD key) to go to the RUN mode. (A reset operation can also be performed in the READY mode using external switch inputs or transmission.)
Set to key lock.	Set variable parameter <i>PA01</i> between 0 to 2.

● **ADV cannot be invoked with PROG and DISP keys**

Cause	Measure
Set to READY mode.	Perform a RUN operation (press the RUN/HOLD key) to go to the RUN mode. (ADV operation can be performed in the READY mode with external switches or through transmission.)
Set to END mode.	Perform a reset operation (press the PROG, RUN and HOLD keys). Invoke the READY mode and perform a RUN operation (press the RUN/HOLD key) to go to the RUN mode.
Set to fixed command control mode.	Set fixed command control data <i>ConSt</i> setting to 0.
Set to key lock.	Set variable parameter <i>PA01</i> between 0 to 2.

● **FAST mode cannot be invoked with FUNC and → keys**

Cause	Measure
Set to program time unit as 0.1 sec.	Set 0 or 1 setup data <i>C62</i> setting.
Set to END mode.	Perform a reset operation (press the PROG, RUN and HOLD keys). Invoke the READY mode and perform a RUN operation (press the RUN/HOLD key) to go to the RUN mode.
Set to fixed command control mode.	Set fixed command control data <i>ConSt</i> setting to 0.
Set to key lock.	Set variable parameter <i>PA01</i> between 0 to 2.

● **MANUAL mode cannot be invoked with A/M key**

Cause	Measure
On-off control is set in <i>P</i> setting = 0.0.	Set the <i>P</i> setting for a currently used PID group to something other than 0.0 to switch from ON-OFF control to PID control.
On-off control is set with segment PID group number = on-off.	Set the segment PID group number between 1 to 9 or to A to switch to PID control.
Set to key lock.	Set variable parameter <i>PA01</i> between 0 to 2.

● **AUTO mode cannot be invoked with A/M key**

Cause	Measure
Set to key lock.	Set variable parameter <i>PA01</i> between 0 to 2.

● **Autotuning (AT) cannot be started with AT key**

Cause	Measure
Set to READY mode. (With variable parameter <i>PA08</i> setting = 1 or 2)	Set RUN mode to execute RUN operation (RUN/HOLD key).
Set to except READY mode. (With variable parameter <i>PA08</i> setting = 3 or 4)	Set READY mode to execute RESET operation (PROG + RUN/HOLD keys).
Set to MANUAL mode.	Set AUTO mode to execute AUTO operation (A/M key).
PV overrange.	Connect PV input correctly to obtain normal input conditions.
AT is set to off	Set variable parameter <i>PA08</i> to something other than 0.
Set to setting instrument (programmer) function.	Set setup data <i>C21</i> to something other than 0.
Set to key lock.	Set variable parameter <i>PA01</i> between 0 to 2.

- **Autotuning cannot be canceled with AT key**

Cause	Measure
Set to key lock.	Set variable parameter <i>PA01</i> between 0 to 2.

- **PID parameter setting state cannot be invoked with PID key**

- **Event configuration setting state cannot be invoked with FUNC and PARA keys**

Cause	Measure
Normal display mode not on	Press DISP key to invoke normal display mode.
Set to key lock.	Set variable parameter <i>PA01</i> to 0 or 2.

- **Setup data setting state cannot be invoked with SETUP key**

Cause	Measure
Normal display mode not on	Press DISP key to invoke normal display mode.
Mode other than READY	Set READY mode to execute RESET operation (PROG + RUN/HOLD keys).
Set to key lock.	Set variable parameter <i>PA01</i> between 0 to 2.

- **Constant value control data setting state cannot be invoked with FUNC and PID keys**

Cause	Measure
Normal display mode not on	Press DISP key to invoke normal display mode.
Mode other than READY	Set READY mode to execute RESET operation (PROG + RUN/HOLD keys).
Set to key lock.	Set variable parameter <i>PA01</i> between 0 to 2.

- **Program setting state cannot be invoked with FUNC and PROG keys**

Cause	Measure
Normal display mode not on	Press DISP key to invoke normal display mode.
Set to constant value control mode.	Set constant value control data <i>ConSt</i> setting to 0.
Set to key lock.	Set variable parameter <i>PA01</i> between 0 to 2.

- **Program copy cannot be performed with ↑ and PROG keys**

Cause	Measure
Mode other than READY	Press DISP key to invoke normal display mode.
Set to be except READY mode.	Set READY mode to execute RESET operation (PROG + RUN/HOLD keys).
Program selected in READY mode is unset.	Select number of a set program.
Constant value control mode is on.	Set constant value control data <i>ConSt</i> to 0.
Program protected	Set variable parameter <i>PA02</i> to 0, 2 or 4.
Set to key lock.	Set variable parameter <i>PA01</i> to 0.

● **General reset cannot be performed with FUNC, CLR and MESSAGE keys**

Cause	Measure
Normal display mode not on	Press DISP key to invoke normal display mode.
Mode other than READY mode	Set READY mode to execute RESET operation (PROG + RUN/HOLD keys).
Set to MANUAL mode.	Set AUTO mode to execute AUTO operation (A/M key).
Set to memory protect.	Set variable parameter <i>PA02</i> to 0.
Set to key lock.	Set variable parameter <i>PA01</i> to 0.

■ **Parameter setting related problems**

● **Registration state cannot be invoked with ENTER key**

Cause	Measure
"-----" displayed in display panel 2	This item cannot be displayed or set. To change setting connection item, it may be able to change or set.
Data displayed in display panel 2 cannot be changed.	This item is display only.
Set to memory protect.	Set variable parameter <i>PA02</i> to 0.

■ **Program setting related problems**

● **Registration state cannot be invoked with ENTER key**

Cause	Measure
Set to memory protect.	Set variable parameter <i>PA02</i> to 0, 2 or 4.

● **Item changes cannot be made with ↑ and ↓ keys**

Cause	Measure
Not pattern item set.	Set SP and time data.

● **SP values in program settings cannot be changed with ↑ and ↓ keys**

Cause	Measure
SP limit sets error value.	Set correct value for setup data <i>C66</i> and <i>C67</i> .

● **Event items cannot be displayed with ↑ and ↓ keys**

Cause	Measure
Event type is something other than segment type.	Set the event type in the event configuration data to a value between 1 and 23.
Programming item sets no display.	Set setup data <i>C57</i> to 0.

● **PID group, output limiter group number items cannot be displayed with ↑ and ↓ keys**

Cause	Measure
Programmer function on	Set setup data C21 to something other than 0.
Programming item display off	Set setup data C58 to 0.

● **G.SOAK items, PV shift items and repeat items cannot be displayed with ↑ and ↓ keys**

Cause	Measure
Programming item display off	Set setup data C59 to 0.

● **PV start items, cycle items and pattern link items cannot be displayed with ↑ and ↓ keys**

Cause	Measure
Programming item display off	Set setup data C60 to 0.

● **Segment insertion and deletion cannot be confirmed with FUNC and ENTER keys**

Cause	Measure
Set to memory protect.	Set variable parameter PA02 to 0, 2 or 4.
Program being set is running (in RUN, HOLD, FAST, END, READY FAST).	Set READY mode to execute RESET operation (PROG + RUN/HOLD keys).
Not set to pattern item on programming map.	Move to the pattern item on the programming map.
This segment is not set on the programming map.	Move to a set segment or set the segment.

● **Program deletion cannot be confirmed with FUNC and ENTER keys during pattern item registration**

Cause	Measure
Program being set is running (in RUN, HOLD, FAST, END, READY FAST).	Set READY mode to execute RESET operation (PROG + RUN/HOLD keys).

10 - 3 When the BAT LED Flashes

Handling Precautions

Batteries that have been stored for long periods have been subject to self-discharge and have a short service life. If required, buy new batteries.

■ BAT LED flashes

The BAT LED starts flashing when low battery voltage is detected. The voltage level set in memory that trigger the LED is higher than minimum level required for storing data.

Thus data loss is thus not imminent when the LED starts flashing.

Note, however, that memory data corruption has probably occurred when the BAT LED starts flashing at power up after the **DCP551** has been stored for long periods disconnected from the power line.

■ Replacing the battery

Parameter settings and program settings are stored in RAM memory. The RAM is backed up by a battery and data persist through a power down. When the battery is depleted, turning off the **DCP551** causes the data stored in RAM to be lost.

CAUTION



Be sure to turn off the power supply when you are replacing the batteries. Failure to heed this warning may lead to electric shock.



Be sure not to touch internal components during battery replacement or just after the power has been turned. This may result in burn injuries.



- Make sure that the batteries are inserted with the plus (+) and minus (–) poles correctly oriented.
 - Do not use damaged batteries or batteries that leak.
 - Do not throw batteries into a fire, recharge, disassemble or expose them to heat.
 - Store batteries in a cool, dry place.
- Failure to heed these cautions may result in burns or battery leakage.



Batteries should be kept out of reach of children, since they may swallow them. Should a child swallow a battery, contact a doctor immediately.



When disposing of used batteries at the user site, observe local bylaws.



Before you touch internal components, be sure to discharge any static electricity on your body by touching a metal ground connector. Failure to heed this caution may lead to equipment damage.

● Items to be provided by the user

- Phillips screwdriver
- New lithium battery: model number 8 14 4 6 14 0-001

- Battery replacement procedures

- ! Handling Precautions

- Replace the old battery with a lithium battery (model no.:81446140-001). Batteries can be ordered from Yamatake Corporation sales or service office.
- Do not use metal tools to remove or attach battery connectors as this could short-circuit electric circuits inside.
- A capacitor backs up the memory during battery replacement. To charge this capacitor, supply power to the **DCP551** for about 10 minutes. Replace the battery less than 24 hours after the power supply has been turned off.

When the BAT LED starts flashing, replace the battery according to the following instructions.

- (1) Leave the power on for about 10 minutes.
- (2) Turn off the power.
- (3) Open the console key cover and remove the lock screw under the **ENTER key** using a Phillips screwdriver.

>>Slide the controller out of the case.

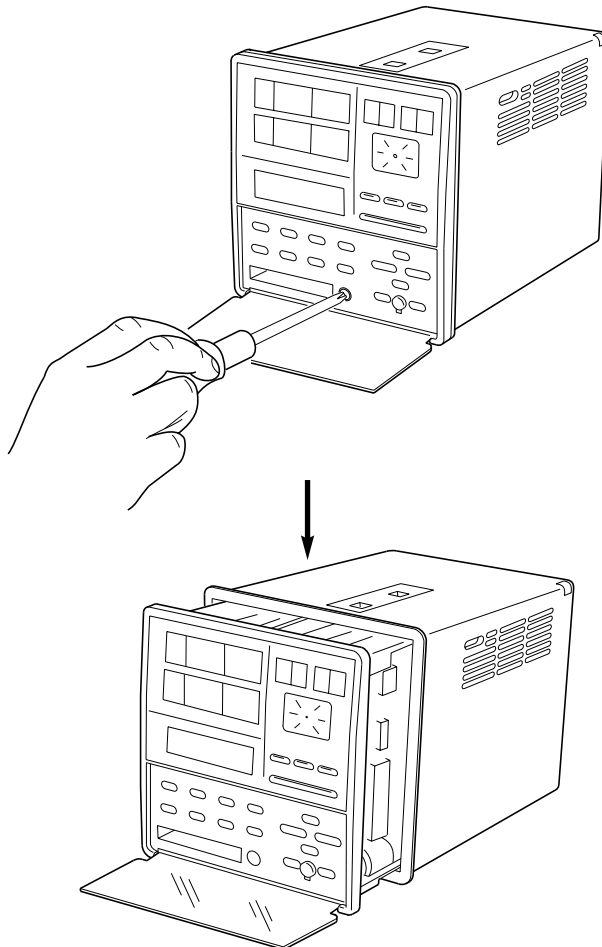

- (4) To prevent static discharges, remove all static electricity from your body.
- (5) Slide the controller completely out of the case.
 - >>The battery is located on the right side as seen from the front of the controller.

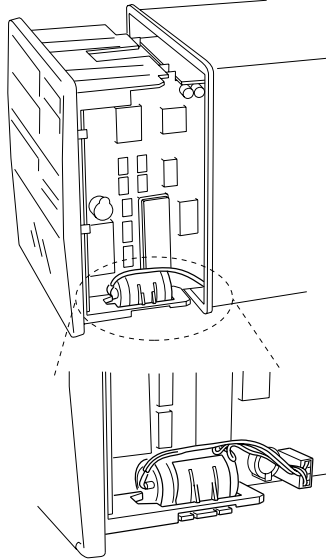

- (6) Place the controller on a desk upside-down so that the battery is easily accessible.
- (7) Disconnect the connectors.
- (8) Open the tab on the black clip that secures the battery and lift out the battery.

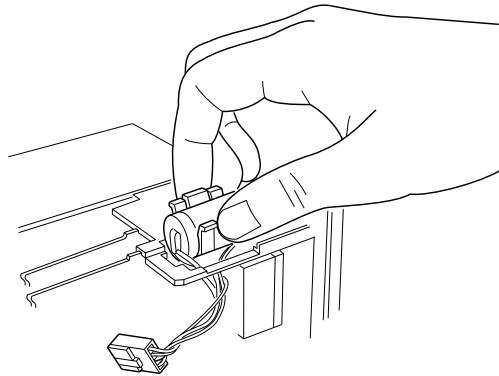

- (9) Remove the old battery from the clip.
- (10) Insert the new battery in the clip.
- (11) Orient the positive pole of the battery forwards and press the clip with the battery into the square opening.
- (12) Insert the connectors in the printed circuit board.
- (13) Slide the controller back into the case.
- (14) Open the key cover and firmly tighten the lock screw under the **ENTER key** using a Phillips screwdriver.
- (15) When all procedures have been completed, affix a label giving the date when the battery should be replaced next time in an easy to see location on the controller.
- (15) Turn on the power to make sure that the **BAT LED** does not go on.

 **NOTE**

- Guidelines for battery service life are given below.
When the **DCP551** is stored with the power off under standard conditions (ambient temperature $23\pm 2^{\circ}\text{C}$): 5 years
When the **DCP551** is stored with the power on under standard conditions (ambient temperature $23\pm 2^{\circ}\text{C}$): 10 years
Battery life is reduced when stored at higher temperatures.
- When the **BAT LED** is flashing, memory data is protected if the power is on.
- When the data in memory is corrupted, one of the following two conditions will occur.
 - (1) “*g.rESt*” is displayed at power up and normal operation cannot be performed.
(Press the **ENTER key** to perform a general reset and reset parameters to their factory default values and delete all program settings.
 - (2) Normal operation can be started at power up but one of the alarm codes *AL93* to *AL97* are displayed.

Chapter 11. SPECIFICATIONS

11 - 1 Specifications

Item		Specifications
Program section	No. of programs	99 programs
	No. of segments	99 segments/1 program, or total 2000 segments
	Segment setting system	RAMP-X: Setting by set points (SP) and time. RAMP-T: Setting by set points (SP) and slope (θ). RAMP-E: Setting by set points (SP) or Δ SP per pulse of external switch input.
	Segment time	0 to 500 hours 00 min, 0 to 500 min 00sec, or 0.0 to 3000.0sec (Time unit is switchable.)
	Segment slope	1 to 10000U/hours, 1 to 10000U/min, or 1 to 10000U/sec (Time unit is switchable.)
	Segment Δ SP	1 to 10000U/1 pulse
	No. of sub-function	4000 settings
	Sub-function function	Event, PID group, output limiter group, G.SOAK, PV shift, repeat
	Event (16 point)	Operating point set as specified by event type.
	PID group setting	Group 0 (continuing from previous segment), groups 1 to 9, group A (automatic changeover) and ON-OFF control settable.
	Output limiter group	Group 0 (continuing from previous segment), groups 1 to 9 settable
	G.SOAK	Type (start point, end point, all) and G.SOAK width 0 to 1000U settable
	PV shift	-10000 to +10000 settable
	Repeat	Return segment number and repeat count settable.
	PV start	Type settable for each program (ascending, descending and bi-directional)
	Cycle	Cycle count number settable for each program
	Pattern link	Program numbers 0 to 99 (program 0 without link) settable for each program
	Tag	8 characters consisting of alphanumerics, katakana and symbols settable for each program
Basic time accuracy	-0.01% (segment time setting = 0, repeat; each cycle and repeat slows the process by 0.1sec)	
Input section	Input type	Thermocouple: K, E, J, T, B, R, S (JIS C1602-1981) WRe5-26 (Hoskins Data) PR40-20 (Johnson Matthey Data) N (N.B.S. Monograph 161) PLII (Engelhard Industries Data (IPTS68)) Ni-NiMo (General Electric Data) Gold iron chromel (Hayashidenko Data) Resistance temperature detector (RTD): Pt100, JPt100 (JIS C1604-1989) DC current: 4 to 20mA, 2.4 to 20mA DC voltage: 0 to 10mV, -10 to +10mV, 0 to 100mV, 0 to 1V, -1 to +1V, 1 to 5V, 0 to 5V, 0 to 10V Multi-range of thermocouple, resistance temperature detector, DC voltage, and DC current(see page 2-8, 2-9).
	Input sampling cycle	0.1s
	Input bias current	Thermocouple, DC voltage input: Max. $\pm 1.3\mu$ A (peak value, under standard conditions). The range higher than 1V is Max. -3μ A.
	Input impedance	DC current input: approx. 50 Ω (under operating conditions)
	Measurement current	RTD input: approx. 1mA, Current input on terminal A. (under operating conditions)
	Influence of wiring resistance	Thermocouple, DC voltage input: Thermocouple : 0.5 μ V/ Ω DC voltage (lower than 1V range) : 0.5 μ V/ Ω DC voltage (5V range) : 3 μ V/ Ω DC voltage (10V range) : 6 μ V/ Ω Resistance temperature detector input: Max. $\pm 0.01\%$ FS/ Ω within wire resistor 0 to 10W The ranges of F01, F33, P01, and P33 are Max. $\pm 0.02\%$ FS/ Ω .
	Resistance temperature detector input	<ul style="list-style-type: none"> The ranges except F01, F33, P01, and P33 are lower than 85Ω. (Includes the zener barrier resistor value. However, spot adjustment is needed.) The ranges of F01, F33, P01, and P33 are lower than 10Ω.
	Allowable parallel resistance	Thermocouple disconnection detection allowable parallel resistance: Higher than 1M Ω .
	Max. allowable input	Thermocouple, DC voltage input: -5 to +15Vdc DC current input : 50mAdc, 2.5Vdc
	Burn out	Burnout on/off selectable
	Range over assessment	100% FS or more: upscaled -10% FS or less : downscaled (However, inputs in the F50 range are not downscaled.)
	Cold junction compensation accuracy	$\pm 0.5^{\circ}$ C (under standard conditions)

Item		Specifications
Input section	Cold junction compensation system	Internal or external compensation (at 0°C) selectable
	Scaling	-19999 to +20000U (Only linear input can sets. Reverse scaling and optional decimal point position can set.)
	Root extraction	Drop out 0.2 to 10.0%. It is possible to set DC current and DC voltage range.
	PV equalizer (linearization)	PV1: 9 broken line (setting to 10 point) PV2: 19 broken line (setting to 20 point)
	Input bias	-1000 to +1000U variable
	Digital filter	0.0 to 120.0sec variable (0.0: Filter off)
External switch input section	Number of input point	16 points
	Connectable output type	No-voltage contact (relay contact), and open corrector (sink current toward 0V)
	Open terminal voltage	8.5 ±0.5V during common terminal ((12) and (40) terminals) and every input terminal (under operating conditions)
	Terminal current in case of short circuit	Current to run every terminal is about 6mA (under operating conditions)
	Allowable contact resistance (no-voltage contact)	On condition: Lower than 250Ω (under operating conditions) Off condition: Higher than 100 kΩ (under operating conditions)
	Allowable residual current (open collector ON)	Lower than 2V (under operating conditions)
	Leakage current (open collector OFF)	Lower than 0.1mA (under operating conditions)
	Parallel connection to another instrument	Connectable with Yamatake Corporation SDC40 or SDC10 series
	Allocation (fixed)	RUN, HOLD, RESET, ADV, program number
	Allocation (variable)	RAMP-E, FAST, AT, AUTO/MANUAL, G.SOAK reset, forward-reverse operation, auto load*, PV1/2 selection
	Input sampling cycle	0.1s
	On detection Min. hold time	0.2s (program number is 0.4s)
Display and setting section	Display panel 1	Digital 5 digits, 7 segments, green color Indicates PV and other data on basic display status, indicates an item code on parameter setting status.
	Display panel 2	Digital 5 digits, 7 segments, orange color Indicates SP, output %, and other data on basic display status, indicates a set point of item on parameter setting status.
	Program number display	Digital 2 digits, 7 segments, green color Indicates a program number on basic display status.
	Segment number display	Digital 2 digits, 7 segments, green color Indicates a segment number on basic display status, indicates a item number on parameter setting status. Indicates an alarm code number when an alarm occurs.
	Message display panel	Indicates output graph, deviation graph, event status, program tag, and other data on basic display status, Indicates a reference message on parameter setting and program setting. Indicates a operation contents and operation result on memory card operation.
	Profile display	7 flat LED, orange color Indicates the rising, soaking, and falling tendencies of program pattern.
	Each status display	22 flat LED Mode : RUN, HLD, MAN, PRG (green color) Display contents: PV, SP, OUT, TM, CYC, SYN, DEV (green color) Battery voltage : BAT (red color) (flickers when the battery voltage has dropped.) Status : AT (green color) Event : EG1, EG2 (red color)
	Operating keys	18 rubber keys (DCP551A***** model), 16 rubber keys (DCP551B***** model)
	Loader connection port	1 (Using exclusive connection cable, stereo pin jack)

* : available on the DCP551A***** model only

Item		Specifications		
Mode	Program run mode	READY	: Preparation state (control stop, select of program number is possible.)	
		RUN	: Advancing run state	
	HOLD	: Hold run state		
	FAST	: Fast feed run state		
Mode	Program run mode	END	: End point run state	
		READY FAST	: Preparation and the fast feed state	
	AUTO	: Automatic run state		
	MANUAL	: Manual run state (output is operatable to console)		
Mode	Fixed command control mode	READY	: Preparation state (control stop)	
		RUN	: Run state	
	AUTO	: Automatic run state		
	MANUAL	: Manual run state (Enables manual output from system console.)		
Control section	PID control	Proportional band (P)	0.0 to 1000.0% (0.0: On-off control)	
		Integral time (I)	0 to 3600s (0: PD control)	
		Derivative time (D)	0 to 1200s (0: PI control)	
		Manipulated variable limit	Low-limit : -5.0% to high-limit High-limit : Low-limit to +105.0%	
		Manual reset	0.0 to 100.0%	
		No. of PID groups	16 groups for program operation (9 segment specific and 7 automatic zone selecting)	
		PID groups selection	Segment specified, automatic zone selectable during program run	
		Manipulated variable change	0.1 to 110.0%/0.1s	
		Auto tuning	Automatic setting of PID value by limit cycle method	
		On-off control differential	0 to 1000U	
	Normal reverse operation selection	Selection is settable		
	Programmer function	Selection	Manipulated variable output is selectable to SP output	
		Scaling	Possible	
		Output resolution	1/10000	
Output section	Auxiliary output	Type	PV, SP, deviation, MV, PV1, PV2	
		Scaling	Possible	
	Current output (5G) Auxiliary output CH1, CH2	Output current	: 4 to 20mA _{dc}	
		Allowable load resistance	: Lower than 600Ω (under operating conditions)	
	Output accuracy	: Lower than ±0.1% FS (under the standard conditions)		
	Output resolution	: 1/10000		
	Max. output current	: 21.6mA _{dc}		
	Min. output current	: 2.4mA _{dc}		
	Output update cycle	: 0.1s		
	Open time terminal voltage	: Lower than 25V		

Item		Specifications	
Output section	Voltage output (6D)	Allowable load resistance : Lower than 600Ω (under operating conditions) Load current adjustment : 2 to 22mA variable Open time terminal voltage: Lower than 25V Off time leakage current : Lower than 100μA Output response time : Lower than 0.5ms, ON to OFF at 600Ω load : Lower than 0.5ms, OFF to ON at 600Ω load Output resolution : 1/1000 Time proportional cycle : 1 to 240s variable	
	Open collector output (8D)	External supply voltage : 12 to 24Vdc Max. load current : 100mA/point Off time leakage current : Lower than 0.1mA On time residual voltage : Lower than 2V Output resolution : 1/1000 Time proportional : 1 to 240s	
Event output section	Open collector output	External supply voltage : 12 to 24Vdc Max. load current : 70mA/point Max. common current : 500mA Off time leakage current : Lower than 0.1mA On time residual voltage : Lower than 2V	
	Event type	PV-based	PV, deviation, deviation standby function is provided, absolute value deviation, absolute value deviation standby function is provided, PV change ratio, SP, MV, G.SOAK absolute value deviation, G.SOAK absolute value deviation standby function is provided, PV1 normal action, PV2 normal action, gap of PV1-PV2 when CH change, gap of PV1-PV2.
		Time-based	Time event, RAMP-E time monitoring, segment time, program time
		Code-based	Code event, timer-bearing code event, program number binary code, segment number binary code, program number BCD code, segment number BCD code
		Mode-based	Specified segment, RUN + HOLD + END + FAST, HOLD, READY + READY FAST, END, G. SOAK standby, MANUAL, AT execution, FAST + READY FAST, console setting operation, RUN, advance, All alarm, PV range alarm, Measuring instrument alarm, PV1 selection, PV2 selection, Lower battery voltage
	Event hysteresis	Set 0 to 1000U with PV-based	
Event on delay	0.0 to 3000.0s are settable for 4 point event		
Communication	RS-485	Network	Multidrop (DCP551 provided with only slave node functionality.) 1 to 16 units max. (DIM), 1 to 32 units max. (CMC, SCM)
		Data flow	Half-duplex
		Sync. system	Start-stop sync.
		Transmission system	Balanced type (differential)
		Data line	Bit serial
		Signal line	Transmit and receive 5 lines (3 wires are connectable)
		Communication speed	1200, 2400, 4800, 9600 bps selectable
		Communication distance	Max. 500m (sum total) 300m in case of MA500 DIM connection
		Others	Conforms to RS-485 standard
		Character composition	11 bits/characters
		Format	1 start bit, even parity, 1 stop bit or 1 start bit, no parity, 2 stop bits

Item		Specifications			
Communi- cation	RS-485	Data length	8 bits		
		Isolation	All inputs and outputs except external switch inputs are completely isolated.		
	RS-485 communications can be performed by connecting to a computer equipped with an RS-485 interface or to Yamatake Corporation's MX200, MA500 (DK link II DIM) or CMC10 controllers.				
	RS-232C	Network	Point to point; (DCP551 provided with only slave node functionality.)		
		Information direction	Half-duplex		
		Sync. system	Start-stop sync.		
		Transmission system	Not-balanced type		
		Data line	Bit serial		
		Signal line	Transmit and receive 3 lines		
		Communication speed	1200, 2400, 4800, 9600 bps selectable		
		Communication distance	Max. 15 m		
		Others	Conforms to RS-232C standard		
		Character composition	11 bits/characters		
		Format	1 start bit, even parity, 1 stop bit or 1 start bit, no parity, 2 stop bits		
Data length		8 bits			
Isolation	All inputs and outputs except external switch inputs are completely isolated				
Memory card (Available on the DCP551A***** model only)	Programs, PID, various parameters (SET UP, PARA, events) and other data can be saved or loaded using memory card (optional).				
	Save (SAVE)	Copies DCP551 data into a card			
	Load (LOAD)	Loads data from a card into the DCP551			
	Memory card (optional)				
	Model No.	Memory type	Capacity bytes	No. of programs	Battery exchange
	SKM008A	RAM	7.00K	Max. 20	Not provided
	SKM016A	RAM	14.50K	Max. 52	Not provided
	SKM064A	RAM	61.75K	Max. 99	Not provided
	SKM256C	RAM	251K	Max. 99	Provided
	SKM008E	EEPROM	7.00K	Max. 20	Not necessity
SKM032E	EEPROM	29.75K	Max. 99	Not necessity	
<ul style="list-style-type: none"> • No. of bytes per program is 26 + (5 X No. of segments) + (5 X No. of sub-functions) • No. of bytes per parameters is as specified below. <ul style="list-style-type: none"> Setup data : 217 bytes Variable parameter : 257 bytes PID parameter + Constant value control data : 291 bytes Event configuration data : 209 bytes 					
General specifications	Memory backup	Memory battery service life Battery backed up RAM DCP551 power off: approx. 5 years under standard conditions DCP551 power on: approx. 10 years under standard conditions			
	Rated power supply voltage	100 to 240Vac 50/60Hz			
	Power consumption	Lower than 25VA			
	Rush current when power supply turns on	Lower than 50A			

Chapter 11. SPECIFICATIONS

Item		Specifications	
General specifications	Action when power supply turns on	Reset time: 10ms max. (time until normal operation possible under normal operating conditions)	
	Service interruption dead time	Lower than 20ms (under operating conditions)	
	Insulation resistance	Higher than 50MΩ under 500Vdc megger between power supply terminal (39)or(40) and FG terminal ((52)or(53))	
	Withstand voltage	1500Vac 50/60Hz for 1min between power terminal and frame ground terminal Note: Primary and secondary sides are capacitive coupled inside the DCP551 . Thus disconnect the ground wire from the secondary side terminal (for example, when using a grounded thermocouple) before performing a withstand voltage test. Failure to do so may result in equipment damage.	
	Standard conditions	Ambient temperature	23 ± 2°C
		Ambient humidity	60 ± 5% RH
		Rated power supply voltage	105Vac ±1%
		Power supply frequency	50 ±1Hz or 60 ±1Hz
		Vibration resistance	0m/s ²
		Shock resistance	0m/s ²
		Mounting angle	Reference plane (vertical) ±3°
	Operating conditions	Ambient temperature range	0 to 50°C (the ambient temperature at the bottom of the case when hermetically sealed inside case)
		Ambient humidity range	10 to 90% RH (non-condensing)
		Rated power supply voltage	105Vac
		Allowable power supply voltage	90 to 264Vac
		Power supply frequency	50 ± 2Hz or 60 ± 2Hz
		Vibration resistance	0 to 1.96m/s ² (10 to 60Hz in X, Y, Z directions for 2 hours each)
		Shock resistance	0 to 9.80m/s ²
		Mounting angle	Reference plane (vertical) ±10°
		Altitude	Max.2000m
	Transportation and storage conditions	Ambient temperature range	-20 to +70°C
		Ambient humidity range	10 to +95% RH (non-condensing)
		Vibration resistance	0 to 4.90m/s ² (10 to 60Hz in X, Y and Z directions, 2hours each)
		Shock resistance	0 to 490m/s ² (in vertical direction, 3 times)
		Package drop test	Drop height 60cm (Free drop at 1 corner, 3 edges, 6 faces)
	Terminal screw	M3.5 self-up screw	
	Terminal screw tighten torque	0.78 to 0.98N·m	
Mask and case material	Mask : Multiron Case : Multiron		
Mask and case color	Musk : Dark gray (Munsell sign 5Y3.5/1) Case : Light gray		
Mounting	Panel flush-mount		
Mass	Approx. 1.5kg		

■ Attachment/auxiliary devices list

	Article name	Model No.	Quantity
Standard attachment	Engineering unit indicator label		1
	Mounting bracket	81446044-001	1 group (2 pcs.)
	Terminal cover	81446176-001	1
Auxiliary devices and others (Optional)	Soft dust-proof cover set	81446141	
	Lithium battery set	81446140-001	
	Memory card (RAM, battery not replaceable)	SKM008A SKM016A SKM064A	Available on the DCP551A***** model only
	Memory card (RAM, battery replaceable)	SKM256C	
	Memory card (EEPROM, no battery required)	SKM008E SKM032E	
		DCP551/552 program work sheet	CP-SP-1002E

11 - 2 External Dimensions

■ DCP551

Unit : mm

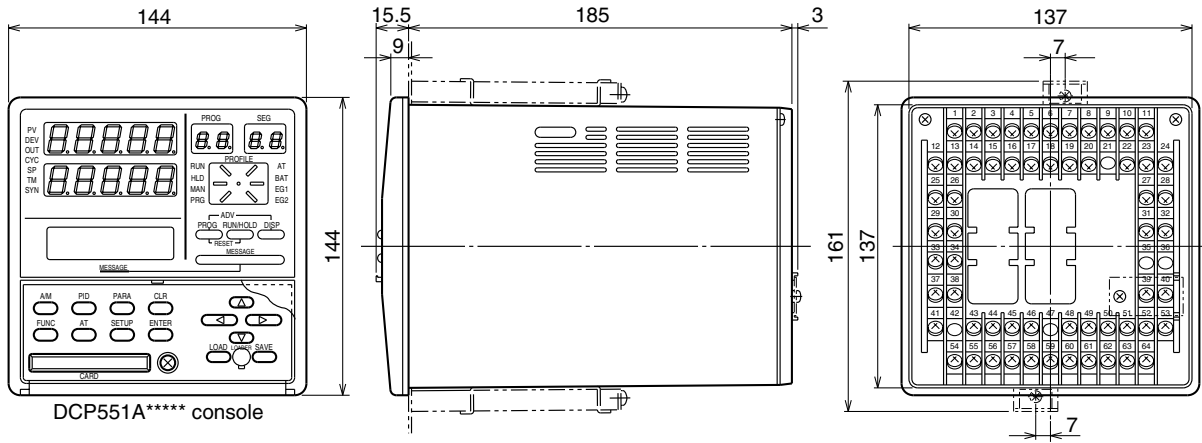

DCP551A**** console

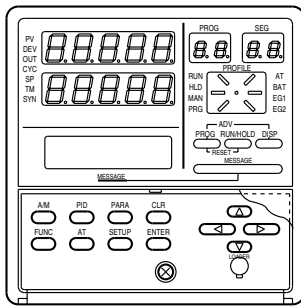

DCP551B**** console

■ Soft dust-proof cover set (optional) Model No. : 81446141 (silicon rubber, transparent)

Unit : mm

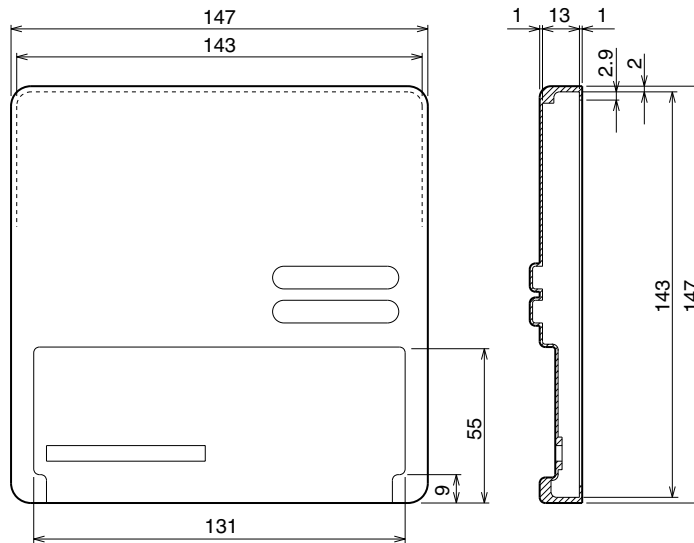

DCP551 Parameter Work Sheet

User name	:	Preparation date	:
Equipment name	:	Product name	:
Model No.	:DCP551	Tag name	:
Instrumentation staffer in charge	:	Business staffer in charge	:

■ Variable parameter setting

No.	Item code	Item	Factory default settings	User settings	Settings and descriptions
1	PA 01	Key lock	0		0: Keylock disabled 1: Display of setup data settings disabled 2: Display of all settings disabled 3: Display of all settings disabled. Operation keys disabled.
2	PA 02	Memory protect	0		0: Disabled 1: Program settings are protected. 2: Setup, variable parameters and event configuration settings are protected. 3: Setup, variable parameters, event configurations and program settings are protected. 4: Setup, variable parameters, event configurations and PID parameter settings are protected. 5: Program settings and all parameter settings are protected.
5	PA 05	Program auto load	0		0: OFF 1: ON
8	PA 08	Auto-tuning	0		0: AT not performed 1: Standard AT performed on currently used PID group in mode other than READY mode 2: AT writing overshoot-proof PID values to currently used PID groups in mode other than READY mode performed 3: Standard AT performed on PID groups A1 to A7 in READY mode 4: AT writing overshoot-proof PID values to PID groups A1 to A7 in READY mode continuously performed
9	PA 09	Auto-tuning MV lower limit	0.0		-5.0 to upper limit %
10	PA 10	Auto-tuning MV higher limit	100.0		Lower limit to +105%
11	PA 11	SP bias	0 SPU		-10000 to +10000 SPU
12	PA 12	PV1 digital filter	0.0		0.0 to 120.0sec
13	PA 13	PV1 bias	0 PVU		-1000 to +1000 PVU(PV1)
14	PA 14	Manipulated variable deviation limit	110.0		0.1 to 110.0% OUT / 0.1sec
15	PA 15	Time proportional output cycle	10		1 to 240sec
16	PA 16	On-off control differential	50 SPU		0 to 1000 SPU
17	PA 17	PID computation initialize manipulated variable	0.0		-5.0 to +105.0%
22	PA 22	PV2 digital filter	0.0		0.0 to 120.0sec
23	PA 23	PV2 bias	0 PVU		-1000 to +1000 PVU(PV2)
31	PA 31	Group 1 event number	0		0 to 16 (0: No delay is specified.)
32	PA 32	Group 1 delay time	0.0		0.0 to 3000.0sec
33	PA 33	Group 2 event number	0		0 to 16 (0: No delay is specified.)
34	PA 34	Group 2 delay time	0.0		0.0 to 3000.0sec
35	PA 35	Group 3 event number	0		0 to 16 (0: No delay is specified.)
36	PA 36	Group 3 delay time	0.0		0.0 to 3000.0sec
37	PA 37	Group 4 event number	0		0 to 16 (0: No delay is specified.)
38	PA 38	Group 4 delay time	0.0		0.0 to 3000.0sec
39	PA 39	FAST X	0		0: 2 X 1: 10 X 2: 60 X 3: 120 X

 denotes items settable only on models with two PV input channels.

DCP551 Parameter Work Sheet

No.	Item code	Item	Factory default settings	User settings	Settings and descriptions
41	PA 41	EG1 LED display event number	0		0 to 16 (0: EG1 LED is off.)
42	PA 42	EG2 LED display event number	0		0 to 16 (0: EG2 LED is off.)
43	PA 43	PID operation initialize	0		0 : No initialization during advance processing and PID group change 1 : Initializes during advance processing but not during PID group change. 2 : No initialization during advance processing but initializes during PID group change. 3 : Initializes both during advance processing and PID group change.
46	PA 46	G.SOAK time	2.0		0.1 to 60.0sec
51	PA 51	PV1 equalizer compensation point No. 1	Range lower limit value		PV1 range lower limit value (tied)
52	PA 52	PV1 equalizer compensation amount No. 1	0 PVU		-1000 to +1000 PVU(PV1)
53	PA 53	PV1 equalizer compensation point No. 2	500 PVU		-19999 to +20000 PVU(PV1)
54	PA 54	PV1 equalizer compensation amount No. 2	0 PVU		-1000 to +1000 PVU(PV1)
55	PA 55	PV1 equalizer compensation point No. 3	1000 PVU		-19999 to +20000 PVU(PV1)
56	PA 56	PV1 equalizer compensation amount No. 3	0 PVU		-1000 to +1000 PVU(PV1)
57	PA 57	PV1 equalizer compensation point No. 4	1500 PVU		-19999 to +20000 PVU(PV1)
58	PA 58	PV1 equalizer compensation amount No. 4	0 PVU		-1000 to +1000 PVU(PV1)
59	PA 59	PV1 equalizer compensation point No. 5	2000 PVU		-19999 to +20000 PVU(PV1)
60	PA 60	PV1 equalizer compensation amount No. 5	0 PVU		-1000 to +1000 PVU(PV1)
61	PA 61	PV1 equalizer compensation point No. 6	2500 PVU		-19999 to +20000 PVU(PV1)
62	PA 62	PV1 equalizer compensation amount No. 6	0 PVU		-1000 to +1000 PVU(PV1)
63	PA 63	PV1 equalizer compensation point No. 7	3000 PVU		-19999 to +20000 PVU(PV1)
64	PA 64	PV1 equalizer compensation amount No. 7	0 PVU		-1000 to +1000 PVU(PV1)
65	PA 65	PV1 equalizer compensation point No. 8	3500 PVU		-19999 to +20000 PVU(PV1)
66	PA 66	PV1 equalizer compensation amount No. 8	0 PVU		-1000 to +1000 PVU(PV1)
67	PA 67	PV1 equalizer compensation point No. 9	4000 PVU		-19999 to +20000 PVU(PV1)
68	PA 68	PV1 equalizer compensation amount No. 9	0 PVU		-1000 to +1000 PVU(PV1)
69	PA 69	PV1 equalizer compensation point No. 10	Range lower limit value		PV1 range upper limit value (tied)
70	PA 70	PV1 equalizer compensation amount No. 10	0 PVU		-1000 to +1000 PVU(PV1)
71	PA 71	PV2 equalizer compensation point No. 1	Low-limit value of range		PV2 range lower limit value (tied)
72	PA 72	PV2 equalizer compensation amount No. 1	0 PVU		-1000 to +1000 PVU(PV2)
73	PA 73	PV2 equalizer compensation point No. 2	500 PVU		-19999 to +20000 PVU(PV2)
74	PA 74	PV2 equalizer compensation amount No. 2	0 PVU		-1000 to +1000 PVU(PV2)
75	PA 75	PV2 equalizer compensation point No. 3	1000 PVU		-19999 to +20000 PVU(PV2)
76	PA 76	PV2 equalizer compensation amount No. 3	0 PVU		-1000 to +1000 PVU(PV2)
77	PA 77	PV2 equalizer compensation point No. 4	1500 PVU		-19999 to +20000 PVU(PV2)
78	PA 78	PV2 equalizer compensation amount No. 4	0 PVU		-1000 to +1000 PVU(PV2)
79	PA 79	PV2 equalizer compensation point No. 5	2000 PVU		-19999 to +20000 PVU(PV2)
80	PA 80	PV2 equalizer compensation amount No. 5	0 PVU		-1000 to +1000 PVU(PV2)
81	PA 81	PV2 equalizer compensation point No. 6	2500 PVU		-19999 to +20000 PVU(PV2)
82	PA 82	PV2 equalizer compensation amount No. 6	0 PVU		-1000 to +1000 PVU(PV2)
83	PA 83	PV2 equalizer compensation point No. 7	3000 PVU		-19999 to +20000 PVU(PV2)
84	PA 84	PV2 equalizer compensation amount No. 7	0 PVU		-1000 to +1000 PVU(PV2)
85	PA 85	PV2 equalizer compensation point No. 8	3500 PVU		-19999 to +20000 PVU(PV2)
86	PA 86	PV2 equalizer compensation amount No. 8	0 PVU		-1000 to +1000 PVU(PV2)
87	PA 87	PV2 equalizer compensation point No. 9	4000 PVU		-19999 to +20000 PVU(PV2)

denotes items settable only on models with two PV input channels.

DCP551 Parameter Work Sheet

No.	Item code	Item	Factory default settings	User settings	Settings and descriptions
88	PA 88	PV2 equalizer compensation amount No. 9	0 PVU		-1000 to +1000 PVU (PV2)
89	PA 89	PV2 equalizer compensation point No. 10	4500 PVU		-19999 to +20000 PVU(PV2)
90	PA 90	PV2 equalizer compensation amount No. 10	0 PVU		-1000 to +1000 PVU(PV2)
91	PA 91	PV2 equalizer compensation point No. 11	5000 PVU		-19999 to +20000 PVU(PV2)
92	PA 92	PV2 equalizer compensation amount No. 11	0 PVU		-1000 to +1000 PVU(PV2)
93	PA 93	PV2 equalizer compensation point No. 12	5500 PVU		-19999 to +20000 PVU(PV2)
94	PA 94	PV2 equalizer compensation amount No. 12	0 PVU		-1000 to +1000 PVU(PV2)
95	PA 95	PV2 equalizer compensation point No. 13	6000 PVU		-19999 to +20000 PVU(PV2)
96	PA 96	PV2 equalizer compensation amount No. 13	0 PVU		-1000 to +1000 PVU(PV2)
97	PA 97	PV2 equalizer compensation point No. 14	6500 PVU		-19999 to +20000 PVU(PV2)
98	PA 98	PV2 equalizer compensation amount No. 14	0 PVU		-1000 to +1000 PVU(PV2)
99	PA 99	PV2 equalizer compensation point No. 15	7000 PVU		-19999 to +20000 PVU(PV2)
100	PA100	PV2 equalizer compensation amount No. 15	0 PVU		-1000 to +1000 PVU(PV2)
101	PA101	PV2 equalizer compensation point No. 16	7500 PVU		-19999 to +20000 PVU(PV2)
102	PA102	PV2 equalizer compensation amount No. 16	0 PVU		-1000 to +1000 PVU(PV2)
103	PA103	PV2 equalizer compensation point No. 17	8000 PVU		-19999 to +20000 PVU(PV2)
104	PA104	PV2 equalizer compensation amount No. 17	0 PVU		-1000 to +1000 PVU(PV2)
105	PA105	PV2 equalizer compensation point No. 18	8500 PVU		-19999 to +20000 PVU(PV2)
106	PA106	PV2 equalizer compensation amount No. 18	0 PVU		-1000 to +1000 PVU(PV2)
107	PA107	PV2 equalizer compensation point No. 19	9000 PVU		-19999 to +20000 PVU(PV2)
108	PA108	PV2 equalizer compensation amount No. 19	0 PVU		-1000 to +1000 PVU(PV2)
109	PA109	PV2 equalizer compensation point No. 20	Range upper limit		PV2 range upper limit value (tied)
110	PA110	PV2 equalizer compensation amount No. 20	0 PVU		-1000 to +1000 PVU(PV2)
111	PA111	PV1 ratio	1.000		0.001 to 9.999
112	PA112	PV2 ratio	1.000		0.001 to 9.999

denotes items settable only on models with two PV input channels.

DCP551 Parameter Work Sheet

■ Event configuration data setting

No.	Item code	Item	Factory default settings	User settings	Settings and descriptions
1	E01-t	Event 1 event type	0		0 to 253
2	E01-1	Event 1 auxiliary setting 1	-----		-19999 to +20000 (Setting range is variable according to the event types.)
3	E01-2	Event 1 auxiliary setting 2	-----		-19999 to +20000 (Setting range is variable according to the event types.)
4	E02-t	Event 2 event type	0		0 to 253
5	E02-1	Event 2 auxiliary setting 1	-----		-19999 to +20000 (Setting range is variable according to the event types.)
6	E02-2	Event 2 auxiliary setting 2	-----		-19999 to +20000 (Setting range is variable according to the event types.)
7	E03-t	Event 3 event type	0		0 to 253
8	E03-1	Event 3 auxiliary setting 1	-----		-19999 to +20000 (Setting range is variable according to the event types.)
9	E03-2	Event 3 auxiliary setting 2	-----		-19999 to +20000 (Setting range is variable according to the event types.)
10	E04-t	Event 4 event type	0		0 to 253
11	E04-1	Event 4 auxiliary setting 1	-----		-19999 to +20000 (Setting range is variable according to the event types.)
12	E04-2	Event 4 auxiliary setting 2	-----		-19999 to +20000 (Setting range is variable according to the event types.)
13	E05-t	Event 5 event type	0		0 to 253
14	E05-1	Event 5 auxiliary setting 1	-----		-19999 to +20000 (Setting range is variable according to the event types.)
15	E05-2	Event 5 auxiliary setting 2	-----		-19999 to +20000 (Setting range is variable according to the event types.)
16	E06-t	Event 6 event type	0		0 to 253
17	E06-1	Event 6 auxiliary setting 1	-----		-19999 to +20000 (Setting range is variable according to the event types.)
18	E06-2	Event 6 auxiliary setting 2	-----		-19999 to +20000 (Setting range is variable according to the event types.)
19	E07-t	Event 7 event type	0		0 to 253
20	E07-1	Event 7 auxiliary setting 1	-----		-19999 to +20000 (Setting range is variable according to the event types.)
21	E07-2	Event 7 auxiliary setting 2	-----		-19999 to +20000 (Setting range is variable according to the event types.)
22	E08-t	Event 8 event type	0		0 to 253
23	E08-1	Event 8 auxiliary setting 1	-----		-19999 to +20000 (Setting range is variable according to the event types.)
24	E08-2	Event 8 auxiliary setting 2	-----		-19999 to +20000 (Setting range is variable according to the event types.)
25	E09-t	Event 9 event type	0		0 to 253
26	E09-1	Event 9 auxiliary setting 1	-----		-19999 to +20000 (Setting range is variable according to the event types.)
27	E09-2	Event 9 auxiliary setting 2	-----		-19999 to +20000 (Setting range is variable according to the event types.)
28	E10-t	Event 10 event type	0		0 to 253
29	E10-1	Event 10 auxiliary setting 1	-----		-19999 to +20000 (Setting range is variable according to the event types.)
30	E10-2	Event 10 auxiliary setting 2	-----		-19999 to +20000 (Setting range is variable according to the event types.)
31	E11-t	Event 11 event type	0		0 to 253
32	E11-1	Event 11 auxiliary setting 1	-----		-19999 to +20000 (Setting range is variable according to the event types.)
33	E11-2	Event 11 auxiliary setting 2	-----		-19999 to +20000 (Setting range is variable according to the event types.)

DCP551 Parameter Work Sheet

No.	Item code	Item	Factory default settings	User settings	Settings and descriptions
34	E12-t	Event 12 event type	0		0 to 253
35	E12-1	Event 12 auxiliary setting 1	----		-19999 to +20000 (Setting range is variable according to the event types.)
36	E12-2	Event 12 auxiliary setting 2	----		-19999 to +20000 (Setting range is variable according to the event types.)
37	E13-t	Event 13 event type	0		0 to 253
38	E13-1	Event 13 auxiliary setting 1	----		-19999 to +20000 (Setting range is variable according to the event types.)
39	E13-2	Event 13 auxiliary setting 2	----		-19999 to +20000 (Setting range is variable according to the event types.)
40	E14-t	Event 14 event type	0		0 to 253
41	E14-1	Event 14 auxiliary setting 1	----		-19999 to +20000 (Setting range is variable according to the event types.)
42	E14-2	Event 14 auxiliary setting 2	----		-19999 to +20000 (Setting range is variable according to the event types.)
43	E15-t	Event 15 event type	0		0 to 253
44	E15-1	Event 15 auxiliary setting 1	----		-19999 to +20000 (Setting range is variable according to the event types.)
45	E15-2	Event 15 auxiliary setting 2	----		-19999 to +20000 (Setting range is variable according to the event types.)
46	E16-t	Event 16 event type	0		0 to 253
47	E16-1	Event 16 auxiliary setting 1	----		-19999 to +20000 (Setting range is variable according to the event types.)
48	E16-2	Event 16 auxiliary setting 2	----		-19999 to +20000 (Setting range is variable according to the event types.)

● Event type

Event type	Meaning	Setting category	Operation category	Auxiliary settings	
0	Event off	----	----	Auxiliary 1 : None	Auxiliary 2 : None
1	Time event	Segment	Time	Auxiliary 1 : None	Auxiliary 2 : None
2	PV upper limit	Segment	PV	Auxiliary 1 : Hysteresis	Auxiliary 2 : None
3	PV lower limit				
4	Deviation upper limit				
5	Deviation lower limit				
6	Deviation upper limit with standby				
7	Deviation lower limit with standby				
8	Absolute value deviation upper limit				
9	Absolute value deviation lower limit				
10	Absolute value deviation upper limit with standby				
11	Absolute value deviation lower limit with standby				
12	PV deviation rate upper limit				
13	PV deviation rate lower limit				
14	SP upper limit	Segment	PV	Auxiliary 1 : Hysteresis	Auxiliary 2 : None
15	SP lower limit				
16	MV upper limit				
17	MV lower limit				
18	Code event	Segment	Code	Auxiliary 1 : No. of output	Auxiliary 2 : None
19	SOAK absolute value deviation upper limit	Segment	PV	Auxiliary 1 : Hysteresis	Auxiliary 2 : None
20	SOAK absolute value deviation lower limit				
21	SOAK absolute value deviation upper limit with standby				
22	SOAK absolute value deviation lower limit with standby				
23	Code event with timer	Segment	Code time	Auxiliary 1 : No. of output	Auxiliary 2 : None

DCP551 Parameter Work Sheet

Event type	Meaning	Setting category	Operation category	Auxiliary settings	
24 to 63	Event off	----	----	Auxiliary 1 : None	Auxiliary 2 : None
64	Normal PV1 upper limit operation	Measuring instrument	PV	Auxiliary 1 : Hysteresis	Auxiliary 2 : Operating point
65	Normal PV1 lower limit operation				
66	Normal PV2 upper limit operation				
67	Normal PV2 lower limit operation				
68	PV upper limit				
69	PV lower limit				
70	Deviation upper limit				
71	Deviation lower limit				
72	Deviation upper limit with standby				
73	Deviation lower limit with standby				
74	Absolute value deviation upper limit				
75	Absolute value deviation lower limit				
76	Absolute value deviation upper limit with standby				
77	Absolute value deviation lower limit with standby				
78	PV deviation rate upper limit	Measuring instrument	PV	Auxiliary 1 : Sampling cycle	Auxiliary 2 : Operating point
79	PV deviation rate lower limit				
80	SP upper limit	Measuring instrument	PV	Auxiliary 1 : Hysteresis	Auxiliary 2 : Operating point
81	SP lower limit				
82	MV upper limit				
83	MV lower limit				
84	SOAK absolute value deviation upper limit				
85	SOAK absolute value deviation lower limit				
86	SOAK absolute value deviation upper limit with standby				
87	SOAK absolute value deviation lower limit with standby				
88	Program No. binary code				
89	Segment No. binary code				
90	Program No. BCD code				
91	Segment No. BCD code				
92	Specified segment	Measuring instrument	Mode	Auxiliary 1 : Segment specification	Auxiliary 2 : None
93	RAMP-E monitoring time	Measuring instrument	Time	Auxiliary 1 : Operating point	Auxiliary 2 : None
94	Segment time	Measuring instrument	Time	Auxiliary 1 : On-time	Auxiliary 2 : OFF-time
95	Program time				
96	PV1-PV2 differential upper limit during CH switching	Measuring instrument	PV	Auxiliary 1 : None	Auxiliary 2 : Operating point
97	PV1-PV2 differential lower limit during CH switching				
98	PV1-PV2 differential upper limit	Measuring instrument	PV	Auxiliary 1 : Hysteresis	Auxiliary 2 : Operating point
99	PV1-PV2 differential lower limit				
100 to 127	Event off	----	----	Auxiliary 1 : None	Auxiliary 2 : None
128	RUN, HOLD, END, FAST	Measuring instrument	Mode	Auxiliary 1 : None	Auxiliary 2 : None
129	HOLD				
130	READY, READY FAST				
131	END				
132	G.SOAK wait				
133	MANUAL				
134	AT executing				
135	FAST, READY FAST				
136	Console setting operation				
137	RUN				

DCP551 Parameter Work Sheet

Event type	Meaning	Setting category	Operation category	Auxiliary settings	
138	Advance	Measuring instrument	Mode	Auxiliary 1 : None	Auxiliary 2 : None
139	All alarms (logical OR)				
140	PV range alarm				
141	Instrument alarm				
142	PV1 selection				
143	PV2 selection				
144	Battery voltage drop				
145 to 253	Event off	-----	-----	Auxiliary 1 : None	Auxiliary 2 : None

DCP551 Parameter Work Sheet

■ PID parameter setting

No.	Item code	Item	Factory default settings	User settings	Settings and descriptions
1	<i>P-1</i>	Proportional band (PID group 1)	100.0		0.0 to 1000.0% (0.0: On-off control)
2	<i>I-1</i>	Integral time (PID group 1)	0		0 to 3600sec (0: no integral operation)
3	<i>d-1</i>	Derivative time (PID group 1)	0		0 to 1200sec (0: no derivative operation)
4	<i>rE-1</i>	Manual reset (PID group 1)	50.0		0.0 to 100.0%
5	<i>oL-1</i>	Manipulated variable lower limit (Output limiter group 1)	0.0		-5.0 to manipulated variable upper limit %
6	<i>oH-1</i>	Manipulated variable upper limit (Output limiter group 1)	100.0		Manipulated variable lower limit to +105.0%
7	<i>P-2</i>	Proportional band (PID group 2)	100.0		0.0 to 1000.0% (0.0: On-off control)
8	<i>I-2</i>	Integral time (PID group 2)	0		0 to 3600sec (0: no integral operation)
9	<i>d-2</i>	Derivative time (PID group 2)	0		0 to 1200sec (0: no derivative operation)
10	<i>rE-2</i>	Manual reset (PID group 2)	50.0		0.0 to 100.0%
11	<i>oL-2</i>	Manipulated variable lower limit (Output limiter group 2)	0.0		-5.0 to manipulated variable upper limit %
12	<i>oH-2</i>	Manipulated variable upper limit (Output limiter group 2)	100.0		Manipulated variable lower limit to +105.0%
13	<i>P-3</i>	Proportional band (PID group 3)	100.0		0.0 to 1000.0% (0.0: On-off control)
14	<i>I-3</i>	Integral time (PID group 3)	0		0 to 3600sec (0: no integral operation)
15	<i>d-3</i>	Derivative time (PID group 3)	0		0 to 1200sec (0: no derivative operation)
16	<i>rE-3</i>	Manual reset (PID group 3)	50.0		0.0 to 100.0%
17	<i>oL-3</i>	Manipulated variable lower limit (Output limiter group 3)	0.0		-5.0 to manipulated variable upper limit %
18	<i>oH-3</i>	Manipulated variable upper limit (Output limiter group 3)	100.0		Manipulated variable lower limit to +105.0%
19	<i>P-4</i>	Proportional band (PID group 4)	100.0		0.0 to 1000.0% (0.0: On-off control)
20	<i>I-4</i>	Integral time (PID group 4)	0		0 to 3600sec (0: no integral operation)
21	<i>d-4</i>	Derivative time (PID group 4)	0		0 to 1200sec (0: no derivative operation)
22	<i>rE-4</i>	Manual reset (PID group 4)	50.0		0.0 to 100.0%
23	<i>oL-4</i>	Manipulated variable lower limit (Output limiter group 4)	0.0		-5.0 to manipulated variable upper limit %
24	<i>oH-4</i>	Manipulated variable upper limit (Output limiter group 4)	100.0		Manipulated variable lower limit to +105.0%
25	<i>P-5</i>	Proportional band (PID group 5)	100.0		0.0 to 1000.0% (0.0: On-off control)
26	<i>I-5</i>	Integral time (PID group 5)	0		0 to 3600sec (0: no integral operation)
27	<i>d-5</i>	Derivative time (PID group 5)	0		0 to 1200sec (0: no derivative operation)
28	<i>rE-5</i>	Manual reset (PID group 5)	50.0		0.0 to 100.0%
29	<i>oL-5</i>	Manipulated variable lower limit (Output limiter group 5)	0.0		-5.0 to manipulated variable upper limit %
30	<i>oH-5</i>	Manipulated variable upper limit (Output limiter group 5)	100.0		Manipulated variable lower limit to +105.0%
31	<i>P-6</i>	Proportional band (PID group 6)	100.0		0.0 to 1000.0% (0.0: On-off control)
32	<i>I-6</i>	Integral time (PID group 6)	0		0 to 3600sec (0: no integral operation)
33	<i>d-6</i>	Derivative time (PID group 6)	0		0 to 1200sec (0: no derivative operation)
34	<i>rE-6</i>	Manual reset (PID group 6)	50.0		0.0 to 100.0%
35	<i>oL-6</i>	Manipulated variable lower limit (Output limiter group 6)	0.0		-5.0 to manipulated variable upper limit %
36	<i>oH-6</i>	Manipulated variable upper limit (Output limiter group 6)	100.0		Manipulated variable lower limit to +105.0%

DCP551 Parameter Work Sheet

No.	Item code	Item	Factory default settings	User settings	Settings and descriptions
37	<i>P-7</i>	Proportional band (PID group 7)	100.0		0.0 to 1000.0% (0.0: On-off control)
38	<i>I-7</i>	Integral time (PID group 7)	0		0 to 3600sec (0: no integral operation)
39	<i>d-7</i>	Derivative time (PID group 7)	0		0 to 1200sec (0: no derivative operation)
40	<i>rE-7</i>	Manual reset (PID group 7)	50.0		0.0 to 100.0%
41	<i>oL-7</i>	Manipulated variable lower limit (Output limiter group 7)	0.0		-5.0 to manipulated variable upper limit %
42	<i>oH-7</i>	Manipulated variable upper limit (Output limiter group 7)	100.0		Manipulated variable lower limit to +105.0%
43	<i>P-8</i>	Proportional band (PID group 8)	100.0		0.0 to 1000.0% (0.0: On-off control)
44	<i>I-8</i>	Integral time (PID group 8)	0		0 to 3600sec (0: no integral operation)
45	<i>d-8</i>	Derivative time (PID group 8)	0		0 to 1200sec (0: no derivative operation)
46	<i>rE-8</i>	Manual reset (PID group 8)	50.0		0.0 to 100.0%
47	<i>oL-8</i>	Manipulated variable lower limit (Output limiter group 8)	0.0		-5.0 to manipulated variable upper limit %
48	<i>oH-8</i>	Manipulated variable upper limit (Output limiter group 8)	100.0		Manipulated variable lower limit to +105.0%
49	<i>P-9</i>	Proportional band (PID group 9)	100.0		0.0 to 1000.0% (0.0: On-off control)
50	<i>I-9</i>	Integral time (PID group 9)	0		0 to 3600sec (0: no integral operation)
51	<i>d-9</i>	Derivative time (PID group 9)	0		0 to 1200sec (0: no derivative operation)
52	<i>rE-9</i>	Manual reset (PID group 9)	50.0		0.0 to 100.0%
53	<i>oL-9</i>	Manipulated variable lower limit (Output limiter group 9)	0.0		-5.0 to manipulated variable upper limit %
54	<i>oH-9</i>	Manipulated variable upper limit (Output limiter group 9)	100.0		Manipulated variable lower limit to +105.0%
55	<i>P-A1</i>	Proportional band (PID group A1)	100.0		0.0 to 1000.0% (0.0: On-off control)
56	<i>I-A1</i>	Integral time (PID group A1)	0		0 to 3600sec (0: no integral operation)
57	<i>d-A1</i>	Derivative time (PID group A1)	0		0 to 1200sec (0: no derivative operation)
58	<i>rE-A1</i>	Manual reset (PID group A1)	50.0		0.0 to 100.0%
59	<i>CP-A1</i>	Switching point (PID group A1)	1000 SPU		-19999 to +20000 SPU
60	<i>tP-A1</i>	Tuning point (PID group A1)	500 SPU		-19999 to +20000 SPU
61	<i>P-A2</i>	Proportional band (PID group A2)	100.0		0.0 to 1000.0% (0.0: On-off control)
62	<i>I-A2</i>	Integral time (PID group A2)	0		0 to 3600sec (0: no integral operation)
63	<i>d-A2</i>	Derivative time (PID group A2)	0		0 to 1200sec (0: no derivative operation)
64	<i>rE-A2</i>	Manual reset (PID group A2)	50.0		0.0 to 100.0%
65	<i>CP-A2</i>	Switching point (PID group A2)	2000 SPU		-19999 to +20000 SPU
66	<i>tP-A2</i>	Tuning point (PID group A2)	1500 SPU		-19999 to +20000 SPU
67	<i>P-A3</i>	Proportional band (PID group A3)	100.0		0.0 to 1000.0% (0.0: On-off control)
68	<i>I-A3</i>	Integral time (PID group A3)	0		0 to 3600sec (0: no integral operation)
69	<i>d-A3</i>	Derivative time (PID group A3)	0		0 to 1200sec (0: no derivative operation)
70	<i>rE-A3</i>	Manual reset (PID group A3)	50.0		0.0 to 100.0%
71	<i>CP-A3</i>	Switching point (PID group A3)	3000 SPU		-19999 to +20000 SPU
72	<i>tP-A3</i>	Tuning point (PID group A3)	2500 SPU		-19999 to +20000 SPU

DCP551 Parameter Work Sheet

No.	Item code	Item	Factory default settings	User settings	Settings and descriptions
73	<i>P-A4</i>	Proportional band (PID group A4)	100.0		0.0 to 1000.0% (0.0: On-off control)
74	<i>I-A4</i>	Integral time (PID group A4)	0		0 to 3600sec (0: no integral operation)
75	<i>d-A4</i>	Derivative time (PID group A4)	0		0 to 1200sec (0: no derivative operation)
76	<i>rE-A4</i>	Manual reset (PID group A4)	50.0		0.0 to 100.0%
77	<i>CP-A4</i>	Switching point (PID group A4)	4000 SPU		-19999 to +20000 SPU
78	<i>tP-A4</i>	Tuning point (PID group A4)	3500 SPU		-19999 to +20000 SPU
79	<i>P-A5</i>	Proportional band (PID group A5)	100.0		0.0 to 1000.0% (0.0: On-off control)
80	<i>I-A5</i>	Integral time (PID group A5)	0		0 to 3600sec (0: no integral operation)
81	<i>d-A5</i>	Derivative time (PID group A5)	0		0 to 1200sec (0: no derivative operation)
82	<i>rE-A5</i>	Manual reset (PID group A5)	50.0		0.0 to 100.0%
83	<i>CP-A5</i>	Switching point (PID group A5)	5000 SPU		-19999 to +20000 SPU
84	<i>tP-A5</i>	Tuning point (PID group A5)	4500 SPU		-19999 to +20000 SPU
85	<i>P-A6</i>	Proportional band (PID group A6)	100.0		0.0 to 1000.0% (0.0: On-off control)
86	<i>I-A6</i>	Integral time (PID group A6)	0		0 to 3600sec (0: no integral operation)
87	<i>d-A6</i>	Derivative time (PID group A6)	0		0 to 1200sec (0: no derivative operation)
88	<i>rE-A6</i>	Manual reset (PID group A6)	50.0		0.0 to 100.0%
89	<i>CP-A6</i>	Switching point (PID group A6)	6000 SPU		-19999 to +20000 SPU
90	<i>tP-A6</i>	Tuning point (PID group A6)	5500 SPU		-19999 to +20000 SPU
91	<i>P-A7</i>	Proportional band (PID group A7)	100.0		0.0 to 1000.0% (0.0: On-off control)
92	<i>I-A7</i>	Integral time (PID group A7)	0		0 to 3600sec (0: no integral operation)
93	<i>d-A7</i>	Derivative time (PID group A7)	0		0 to 1200sec (0: no derivative operation)
94	<i>rE-A7</i>	Manual reset (PID group A7)	50.0		0.0 to 100.0%
95	<i>CP-A7</i>	Switching point (PID group A7)	20000SPU (fixed)		20000 SPU (tied)
96	<i>tP-A7</i>	Tuning point (PID group A7)	6500 SPU		-19999 to +20000 SPU

■ Setup data setting

No.	Item code	Item	Factory default settings	User settings	Settings and descriptions
1	C 01	PV1 range number	0		0 to 16 : Thermocouple 48 to 52 : Linear (DC current and DC voltage) 64 to 71 : Resistance temperature detector 96 to 103 : Resistance temperature detector 128 to 134 : Linear (DC current and DC voltage)
2	C 02	PV1 temperature unit	0		0 : Celsius (°C) 1 : Fahrenheit (°F)
3	C 03	PV1 decimal point position	1		0 to 2
4	C 04	PV1 linear decimal point position	1		0 to 4
5	C 05	PV1 linear range lower limit	0 PVU		−19999 to +20000 PVU(PV1)
6	C 06	PV1 linear range upper limit	10000 PVU		−19999 to +20000 PVU(PV1)
7	C 07	PV1 cold junction compensation	0		0 : Provided (Compensated inside the instrument) 1 : Not provided (Compensated outside the instrument)
8	C 08	PV1 root extraction	0		0 : Not provided 1 : Provided
9	C 09	PV1 root extraction dropout	0.2		0.2 to 10.0% (Ratio to input range)
10	C 10	PV1 cold junction bias	0.0		−1.0 to + 1.0°C
11	C 11	PV2 range number	0		0 to 16 : Thermocouple 48 to 52 : Linear (DC current and DC voltage) 64 to 71 : Resistance temperature detector 96 to 103 : Resistance temperature detector 128 to 134 : Linear (DC current and DC voltage)
12	C 12	PV2 temperature unit	0		0 : Celsius (°C) 1 : Fahrenheit (°F)
13	C 13	PV2 decimal point position	1		0 to 2
14	C 14	PV2 linear decimal point position	1		0 to 4
15	C 15	PV2 linear range lower limit	0 PVU		−19999 to +20000 PVU(PV2)
16	C 16	PV2 linear range upper limit	10000 PVU		−19999 to +20000 PVU(PV2)
17	C 17	PV2 cold junction compensation	0		0 : Provided (Compensated inside the instrument) 1 : Not provided (Compensated outside the instrument)
18	C 18	PV2 root extraction	0		0 : Not provided 1 : Provided
19	C 19	PV2 root extraction dropout	0.2		0.2 to 10.0% (Ratio to input range)
20	C 20	PV2 cold junction bias	0.0		−1.0 to + 1.0°C
21	C 21	Control output system	1		0 : 5S output (Current proportional SP output) 1 : 5G output (Current proportional control output) 2 : 6D output (Voltage time proportional control output) system A 3 : 6D output (Voltage time proportional control output) system B 4 : 8D output (open collector time proportional control output) system A 5 : 8D output (open collector time proportional control output) system B
23	C 23	Control action	0		0 : PID — A reverse operation 1 : PID — A normal operation 2 : PID — B reverse operation 3 : PID — B normal operation
25	C 25	PV channel switching type	0		0 : PV1 low-temperature sensor, PV2 high-temperature sensor 1 : PV1 high-temperature sensor, PV2 low-temperature sensor 2 : PV1 tied 3 : PV2 tied 4 : Backup switching
26	C 26	PV channel switching system	0		0 : External switch switching 1 : Automatic switching (switching + dead band) 2 : Automatic switching B (switching + dead band + external switch) 3 : Automatic switching C (2-point proportional)
27	C 27	PV channel switching point	10000 PVU		−19999 to +20000 PVU(PV1)
28	C 28	PV channel switching dead band	100 PVU		1 to 1000 PVU(PV1)

denotes items settable only on models with 0 two PV input channels.

DCP551 Parameter Work Sheet

No.	Item code	Item	Factory default settings	User settings	Settings and descriptions
29	C 29	Selections available when power is on during PV channel switching	0		0: Continues until power is turned off. 1: PV1 2: PV2 3: High-temperature PV 4: Low-temperature PV
30	C 30	PV equalizer	0		0: Not provided 1: PV1 only 2: PV2 only 3: Both PV1 and PV2
31	C 31	End of operation	0		0: READY mode 1: END mode
32	C 32	Manipulated variable in READY mode	0.0		-5.0 to +105.0%
33	C 33	Manipulated variable setting in PV overrange	0		0: Not provided 1: Provided
34	C 34	Manipulated variable in PV overrange	0.0		-5.0 to +105.0%
35	C 35	MANUAL change mode	0		0: Smooth 1: Preset
36	C 36	Preset MANUAL value	0.0		-5.0 to +105.0%
43	C 43	Service interruption time when running can be continued	0		0 to 3600sec
45	C 45	Auxiliary output 1 type	0		0: SP 1: PV 2: Deviation (DEV) 3: Manipulated variable (MV) 4: PV1 5: PV2
46	C 46	Auxiliary output 1 lower limit (4mA)	0 SPU		-19999 to +20000 SPU (C45 not equal to 3) -1999.9 to +2000.0% (C45 set to 3)
47	C 47	Auxiliary output 1 upper limit (20mA)	10000 SPU		-19999 to +20000 SPU (C45 not equal to 3) -1999.9 to +2000.0% (C45 set to 3)
48	C 48	Auxiliary output 2 type	0		0: SP 1: PV 2: Deviation (DEV) 3: Manipulated variable (MV) 4: PV1 5: PV2
49	C 49	Auxiliary output 2 lower limit (4mA)	0 SPU		-19999 to +20000 SPU (C48 not equal to 3) -1999.9 to +2000.0% (C48 set to 3)
50	C 50	Auxiliary output 2 upper limit (20mA)	10000 SPU		-19999 to +20000 SPU (C48 not equal to 3) -1999.9 to +2000.0% (C48 set to 3)
52	C 52	SP output lower limit (4mA)	0 SPU		-19999 to +20000 SPU
53	C 53	SP output upper limit (20mA)	10000 SPU		-19999 to +20000 SPU
57	C 57	Programming item Event	0		0: Displayed 1: Not displayed
58	C 58	Programming item PID group, output limiter group	0		0: Displayed 1: Not displayed
59	C 59	Programming item G.SOAK, PV shift, repeat	0		0: Displayed 1: Not displayed
60	C 60	Programming item PV start, cycle, pattern link	0		0: Displayed 1: Not displayed
61	C 61	Programming system	0		0: RAMP-X and RAMP-T (θ) combined 1: RAMP-X and RAMP-E (Δ SP) combined
62	C 62	Program time unit	0		0: Hours, min (SPU/hour for RAMP-T) 1: Min, sec (SPU/min for RAMP-T) 2: 0.1 sec (SPU/sec for RAMP-T)
63	C 63	Time display (display panel 2)	0		0: Remaining segment time 1: total operation time (after READY → RUN start)
65	C 65	SP decimal point position	1		0 to 4

denotes items settable only on models with two PV input channels.

DCP551 Parameter Work Sheet

No.	Item code	Item	Factory default settings	User settings	Settings and descriptions
66	C 66	SP limit lower limit	PV1 range lower limit		-19999 to +20000 SPU
67	C 67	SP limit upper limit	PV1 range upper limit		-19999 to +20000 SPU
71	C 71	External switch input RSW5	0		0 : NOP (does not function.) 1 : RAMP—E 2 : FAST
72	C 72	External switch input RSW6	0		3 : G.SOAK is cleared using OR. 4 : G.SOAK is cleared using AND. 5 : AUTO/MANUAL
73	C 73	External switch input RSW7	0		6 : AT 7 : PV1/PV2 8 : Auto load
74	C 74	External switch input RSW8	0		9 : PV1 → PV2 standby 10 : PV2 → PV1 standby 11 : NOP (does not function.) 12 : Normal operation/reverse operation
75	C 75	External switch input RSW9 to 16 (program selection)	0		0 : BCD4 bit X 2 digits 1 : Binary 7 bits
76	C 76	Communication address	0		0 to 127
77	C 77	Transmission rate	0		0 : 9600bps 1 : 4800bps 2 : 2400bps 3 : 1200bps
78	C 78	Transmission code	0		0 : 8 bits, even parity, 1 stop bit 1 : 8 bits, no parity, 2 stop bits
79	C 79	Communication protocol	0		0 : CPL 1 : ST221 (no PV trend) 2 : ST221 (PV trend)
80	C 80	Communication method	0		0 : RS-485 1 : RS-232C
81	C 81	ROM ID	—		< Description >
82	C 82	ROM ITEM	—		Can only be referenced for mechanical service use.
83	C 83	ROM revision	—		
84	C 84	Data version	—		
85	C 85	CPU board ID	—		
86	C 86	I/O board ID	—		
90	C 90	PID type	1		0 : Improved 1 : Compatible with Mark I
91	C 91	PV1 burnout	0		0 : Provided 1 : Not provided
92	C 92	PV2 burnout	0		0 : Provided 1 : Not provided
93	C 93	Time proportional output system	0		0 : Does not go on a second time off in time proportional cycle. 1 : Goes on a second time in time proportional cycle.
95	C 95	Voltage output tuning	15		2 to 22mA
97	C 97	Communication port	0		0 to 15 Uses back plate terminal to setting 0. Uses loader jack to setting 1 to 15.
98	C 98	Special function	0		0 to 255
99	C 99	PV1 zener barrier adjustment	—		-20.00 to +20.00
100	C100	PV2 zener barrier adjustment	—		-20.00 to +20.00

denotes items settable only on models with two PV input channels.

DCP551 Parameter Work Sheet

■ Constant value control data setting

No.	Item code	Item	Factory default settings	User settings	Settings and descriptions
1	<i>ConSt</i>	Control mode	0		0 : Program run mode 1 : Constant value control mode
2	<i>SP</i>	Set point	0		Within setup C66 to C67 setting (SP limit)
3	<i>P</i>	Proportional band	100.0		0.0 to 1000.0% (0.0 : On-off control)
4	<i>I</i>	Integral time	0		0 to 3600sec (0: no integral operation)
5	<i>d</i>	Derivative time	0		0 to 1200sec (0: no derivative operation)
6	<i>rE</i>	Manual reset	50.0		0.0 to 100.0%
7	<i>oL</i>	Manipulated variable lower limit	0.0		-5.0 to upper limit%
8	<i>oH</i>	Manipulated variable upper limit	100.0		Lower limit to +105.0%

Index

-A-

ADV (advance) 5-26, 5-27
Alarm 10-2
Attachment 11-7
AUTO (auto) 5-25, 5-26, 5-27
Automatic PID group selection 5-16
Auto-tuning (AT) 6-12
Auxiliary device 11-7
Auxiliary output 4-10, 5-39, 7-28

-B-

Basic functions 1-2
BAT LED 10-8
Battery replacement procedure 10-9

-C-

Cable 4-3
Case 2-1
Channel selection 5-32
Code event 5-12
Cold junction compensating 5-30, 5-31, 7-28
Communication connection 4-13
Console 2-1, 2-2
Constant value control 5-24
Constant value control data 7-1, 7-34
Control output 4-9, 5-37
Controller 5-29
CPL communication 1-4
CR filter 3-2
Crimp-style solderless wire connectors 4-4
Cycle 5-21, 8-17

-D-

Data 1-3, 5-1
DC current 2-9, 4-7, 4-8
DC voltage 2-9, 4-7, 4-8
Display 2-2
Display panel 1 2-2, 2-3
Display panel 2 2-2, 2-3
Dust proof cover 3-2, 11-7

-E-

EG1 LED 7-11
EG2 LED 7-11
END (end) 5-25
End of run 5-26, 5-27
Error message list (memory card) 9-12

Event 5-5, 8-7
Event configuration data 7-1, 7-12
Event on delay 7-11
Event output (open collector output) connection 4-11
External dimensions 11-8
External switch input connection 4-12
External switch operation 6-8

-F-

FAST (fast) 5-25, 5-27

-G-

G.SOAK (guarantee soak) 5-17, 8-13
General reset 2-6, 8-24
Grounding 4-6

-H-

HOLD (hold) 5-25, 5-27

-I-

Input process 5-30
Input type 2-8
Isolating input and outputs 4-18

-K-

Key 2-4
Key cover 2-1
Key input related problems 10-3
Key lock 7-9

-L-

Load operation (memory card) 9-6
Loader jack 2-7
Lock screw 2-1

-M-

Main unit 2-1
Manipulated variable deviation rate limit 7-10
MANUAL (manual) 5-25, 5-26, 5-27, 6-12
Memory card function 9-1
Memory card operation 2-6, 9-1
Memory card type 9-1
Memory protect 7-9
Message display 2-2, 2-3
Mode 5-24
Mode display LED 2-2, 2-3
Mode event 5-15

Mode switching 5-26, 5-27, 5-28
 Model numbers 1-5
 Mounting bracket 3-4, 11-7
 Mounting method 3-4
 Mounting position 3-1

-N-

Noise 3-2
 Normal display mode 2-2, 2-5
 Normal display mode LED 2-2

-O-

On-off control differential 7-10
 Operating 2 or more keys 2-6
 Output limiter group 5-16, 8-12
 Output process 5-37

-P-

Panel cutout dimension 3-3
 Parameter 1-3, 5-1
 Parameter setting 2-5, 7-1, 7-4
 Parameter setting 2-5, 2-6, 8-1
 Pattern 5-2
 Pattern link 5-22, 8-18
 PID computation initialize 7-11
 PID computation initialize manipulated variable 7-11
 PID group 5-16, 8-12
 PID parameter 7-1, 7-18
 Power supply 4-6
 Power supply on 6-1
 Profile display 2-2, 2-3, 6-2
 Program 1-3, 5-1, 5-2
 Program auto load 7-10, 9-10
 Program clear 8-20
 Program copy 2-6, 8-23
 Program number display 2-2, 2-3
 Program running 5-24
 Program selection 6-7, 6-9
 Programmer 5-29
 Programming map 8-4
 PV deviation rate event 5-11
 PV input (analog input) connection 4-7
 PV shift 5-18, 8-14
 PV start 5-20, 8-16
 PV type event 5-8

-R-

Range No. 2-8
 READY (ready) 5-24
 READY FAST (ready fast) 5-25
 Repeat 5-19, 8-15
 RESET (reset) 5-27
 Resistance temperature detector 2-8, 4-7
 Root extraction 5-30, 5-31, 7-28
 RS-232C 1-4, 4-16
 RS-485 1-4, 4-14, 4-15
 RUN (run) 1-4, 4-16

-S-

Save operation (memory card) 9-2
 Segment deletion 8-21
 Segment insertion 8-21
 Segment number display 2-2, 2-3
 Selection of display 6-2
 Self-diagnostic 10-1
 Setup data 7-1, 7-21
 SP limit 5-25, 5-27
 SP output 1-4, 4-14, 4-15
 Specifications 11-1
 ST221 5-39, 7-29

-T-

Tag 5-23, 8-19
 Terminal array 4-5
 Terminal base 2-1, 4-5
 Terminal connection 4-4
 Terminal cover 2-1, 11-7
 Thermocouple 2-8, 4-7
 Time display 7-29
 Time event 5-5
 Time proportional output system 7-30

-V-

Variable parameter 7-1, 7-5
 Varistor 3-2
 Voltage output control 7-30

-W-

Wiring 4-1

Revision History

Printed date	Manual Number	Edition	Revised pages	Description
June 1998	CP-SP-1032E	1st Edition		
Mar. 1999		2nd Edition	4-16	DCP551/552 Program Work Sheet CP-SP-1002E was obsoleted Yamatate Corporation CBL-232Z08 deleted, wiring diagram of RS-232C connection was changed
Nov. 1999		3rd Edition	7-26 Parameter Work Sheet P.13	No.C90 unused → PID type was changed No.C90 was added
May 2000		4th Edition	v 6-8	Manual No.CP-UM-1001E → CP-SP-1001E was changed Section of "SW5 to SW8 Function" Addition of explanation
June 2001		5th Edition	v 1-4 4-6 4-14 4-15 4-16 9-9 10-9 11-5 11-6	Manual No.CP-SP-1001E deleted Deleted description of CMA50A105, and "Handling Precautions" deleted Category 3 or higher → Less than 100Ω changed Deleted description of CMA50A105 "Handling Precautions" changed The 2nd item of "Handling Precautions", 'There are four (RD, SD, SG and FG) •••' → 'There are three (RD, SD and SG) •••' changed and the 3rd item of "Handling Precautions" deleted Set up data C91 → C90 changed Changed description of the 3rd item of "Handling Precautions" CMA50 → CMC10 changed Weight → Mass changed
Oct. 2001		6th Edition	1-5 4-16 6-4	Contents of D0 and Y0 changed "Handling Precautions" deleted Display A6 PV → SP corrected
Feb. 2004		7th Edition	i iv 1-4 4-2 4-14,4-15 7-30 10-8 11-6	RESTRICTIONS ON USE changed Category II (IEC664-1, IEC1010-1) → (IEC60364-4-443, IEC60664-1) changed 30Vrms, 42.4V peak and 60Vdc. → 33Vrms, 46.7V peak and 70Vdc. changed CAUTION 7th item changed an annotation changed Handling Precautions added Handling Precautions added The 2nd item's diagram of C93 replaced CAUTION 5th item changed Operating conditions "Altitude:Max.2000m" added
May 2004		8th Edition	4-3 7-30	NOTE 1st item polyethelene insulated vinyl sheathed cable for JCS-364 → JCS4364 instrument cable changed ●C95 Constant current type SSR added
Nov. 2005		9th Edition	11-1 11-7, 11-8	Input type explanation added Soft dust-proof cover set Model No. 81446141-001 → 81446141 changed
July 2006		10th Edition	v 2-9	"The Role of This Manual" deleted "Handling Precautions" item added
May 2007		11th Edition	ii 10-2	SAFETY PRECAUTIONS ■ Example changed. ■ Display behavior and alarm code upon input burnout added.
Dec. 2007		12th Edition	1-2,2-2,2-6,4-18, 6-8,7-5,7-10,9-1, 11-2,11-5,11-7	DCP551B***** model added.

azbil

Yamatake Corporation
Advanced Automation Company

1-12-2 Kawana, Fujisawa
Kanagawa 251-8522 Japan

URL: <http://www.azbil.com>

Printed on recycled paper. (07)

Specifications are subject to change without notice.

Printed in Japan.
1st Edition: Issued in June 1998 (W)
12th Edition: Issued in Dec. 2007 (A)